

Micro discharge measurement

Kinki University

Yukihiro Kato

Gas Electron Multiplier

GEM consists of a thin insulator (50, 100 μm) on which both side is covered by a thin metal (about 5 μm) layer and has many holes (diameter of 70 μm , pitch of 140 μm).

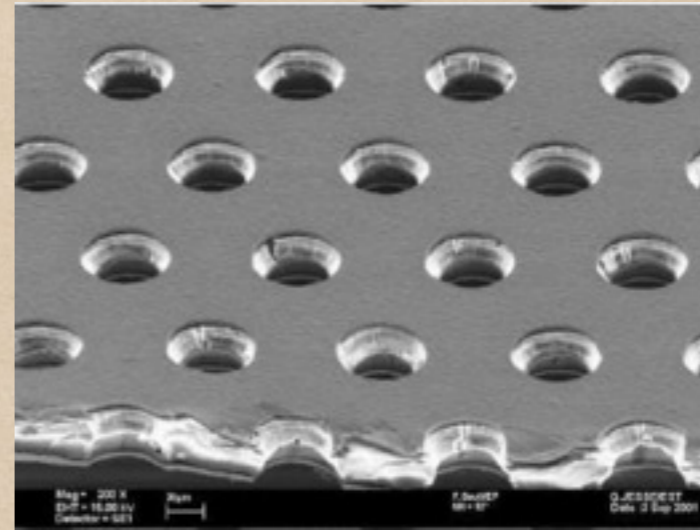
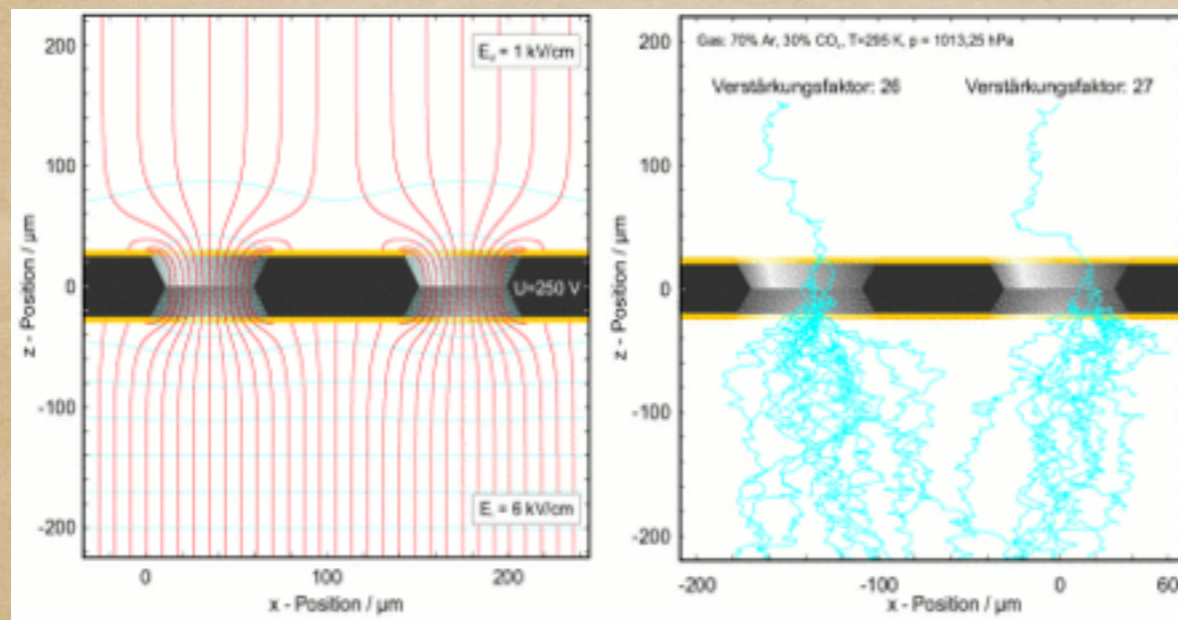

Image of the GEM structure taken with an electron microscope (image from [CERN GDD group](#)).



Sketch of the working principle of a GEM. Left side shows the field lines (red) in a GEM hole. The right side shows the multiplication of a single electron - turquoise lines show electron paths- in GEM holes (both images by O. Schäfer).

Working principle of GEM

- (1) Applying the high voltage between the upper and lower metal layers. The inside of holes generates high electric field.
- (2) The electron pass through the detector go into the holes and get the much energy by the high electric field.
- (3) The electron ionizes the molecule of gas. The repetition of this ionization generates many electron (gas amplification).

How to make GEM?

Chemical etching

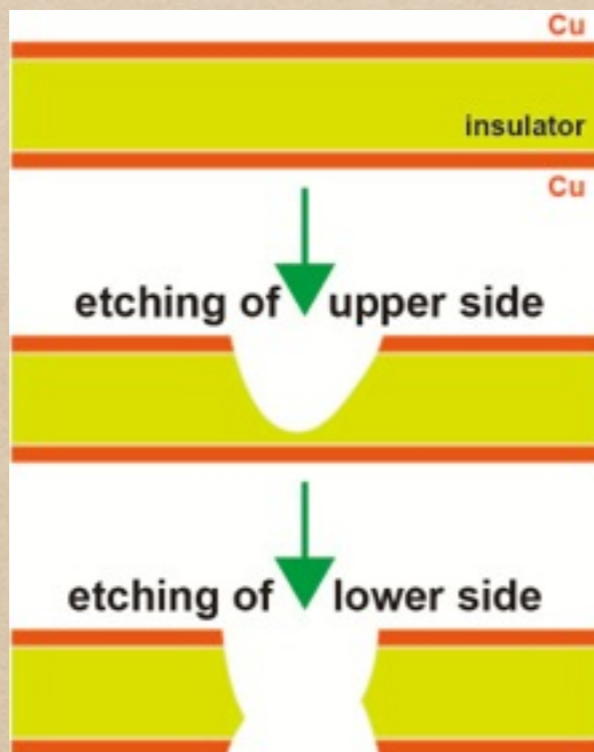

- CERN and Raytech
- Insulator is polyimide
- Conical holes (need etching from both side)

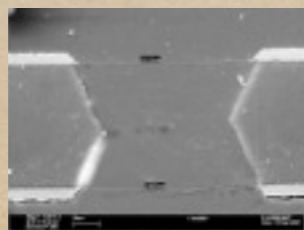

CERN GEM

Laser etching

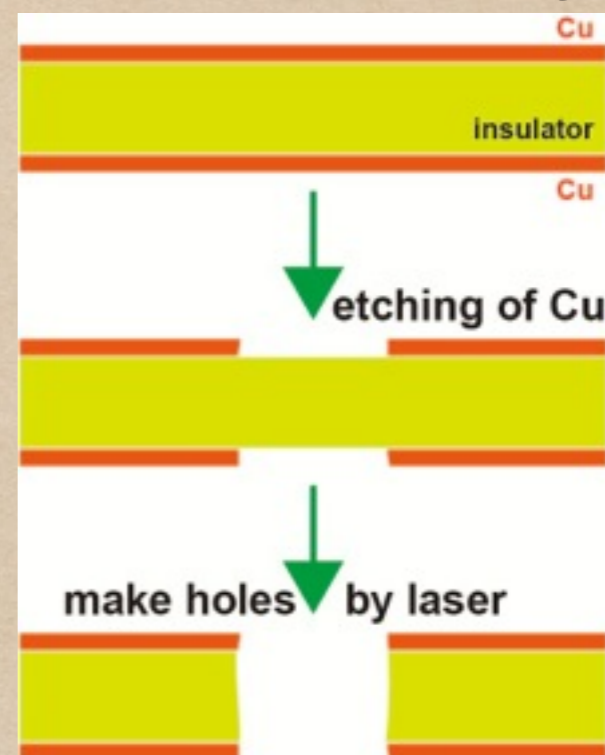

- Scienergy
- Insulator is LCP (liquid crystal polymer)
- Straight holes
- can make thicker GEM

**We use thicker (100um)
GEM on LP1 module**

Why discharge is a problem?

We use 100 um thick GEM

- 2 layer can get a suitable gain
- 50 um GEM needs to stack on 3 layers
- 2 layer has less parts (HV, support, etc) than 3 layer

But....

- Our GEM happens micro discharge frequently (10^{-3} /charged particle)
- Micro discharge causes the gain drop
- DESY GEM (made by CERN) didn't happen micro discharge

If the discharge rate of 100 um GEM is higher than 50 um GEM, we have to replace 50 um GEM from 100 um GEM in our TPC.



need to
check

Discharge on Testbeam

Asian Module: GEM discharges

- Observed gain drops in TB data
- Observed discharges in GEM test
- Too high frequency!

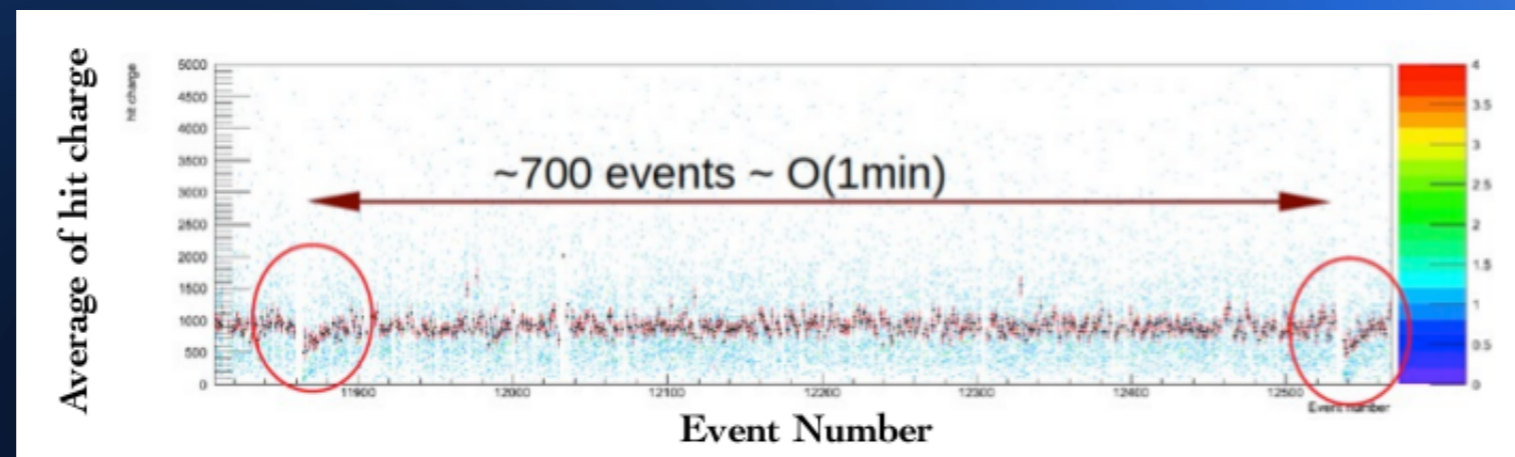

2013-05-29

TPC status
Philippe Gros, Saga University

9

Our GEM really happens the discharge rather than other GEMs?

Setup of measurement

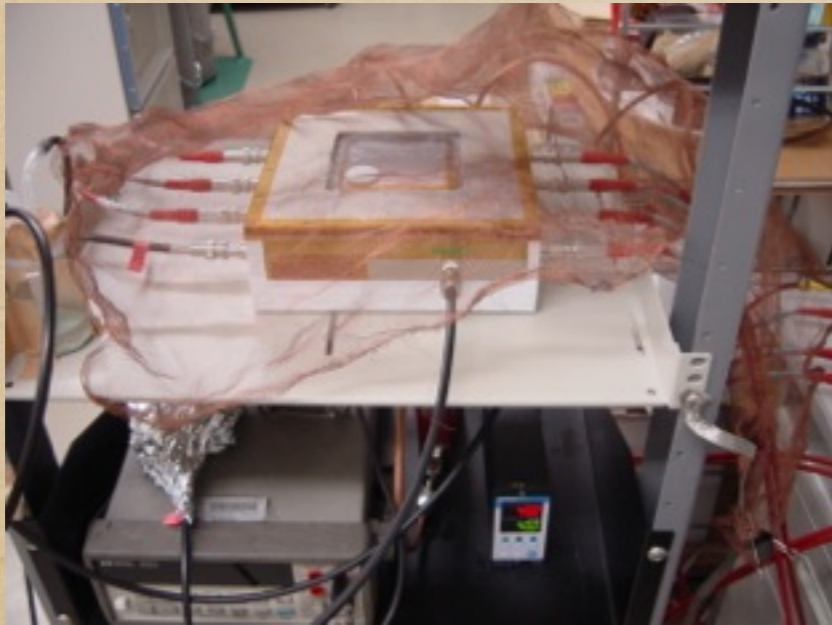

chamber picture

- small GEM module (20X20X4.8 cm)
- Gas pipe: Cu, SUS
- HV module: CAEN N1470A (resolution - 5nA)
- GEM:
 - 50 μm (10cm X 10cm) – triple GEM structure
 - 100 μm (10cm X 10cm) – double GEM structure
- Gas: T2K(Ar 95%+CF₄ 3%+i-C₄H₁₀ 2%)
- Amp: CANBERRA (preamp:2004, charge amp:2012)

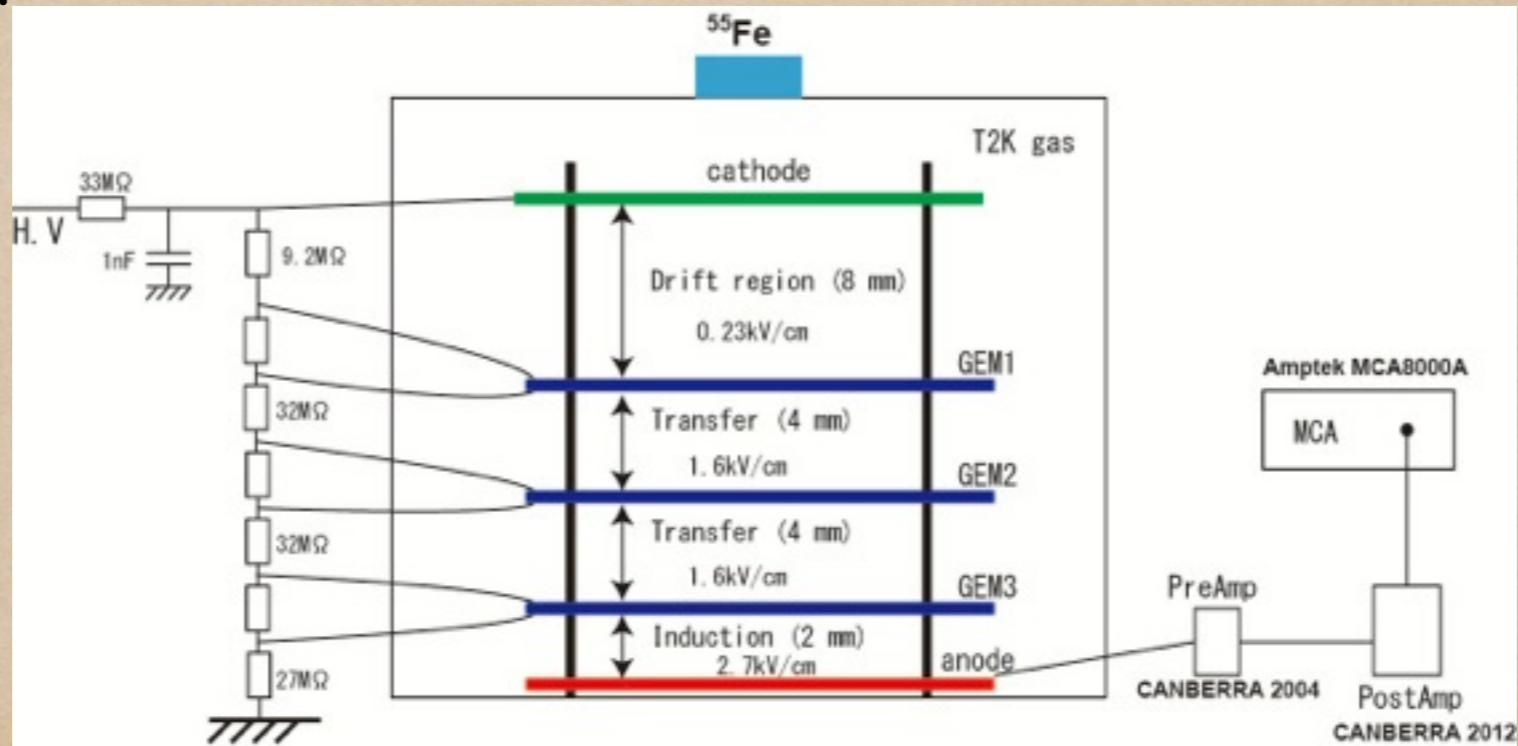

setup of measurement

GEM

standard GEM structure
10cmX10cm, hole - $70\mu\text{m}\Phi$, pitch - $140\mu\text{m}$

Using below type of GEM

50 μm GEM (triple layer)

- CERN - chemical etching
- Scienergy - laser etching
- Raytech - chemical etching

100 μm GEM (double layer)

Scienergy - laser etching

definition of discharge

Define of discharge

If a current on the system is raised up suddenly, the discharge will be happened and the current will be a discharged current.

$$\text{discharged current } (\mu\text{A}) > \text{norm. current} + 0.015\mu\text{A}$$

Norm. current is the average of the current just before 10 without discharge current.
(precision of current: $0.005 \mu\text{A}$)

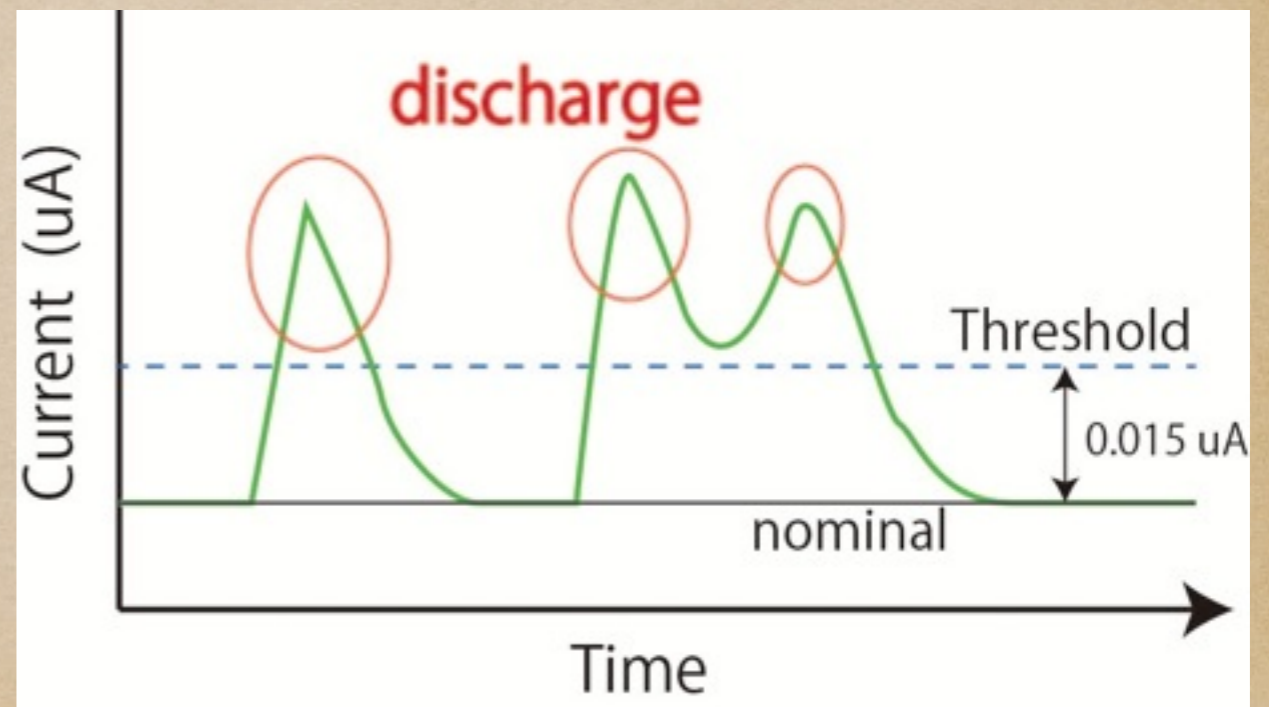

Results of measurements (50um GEM)

CERN

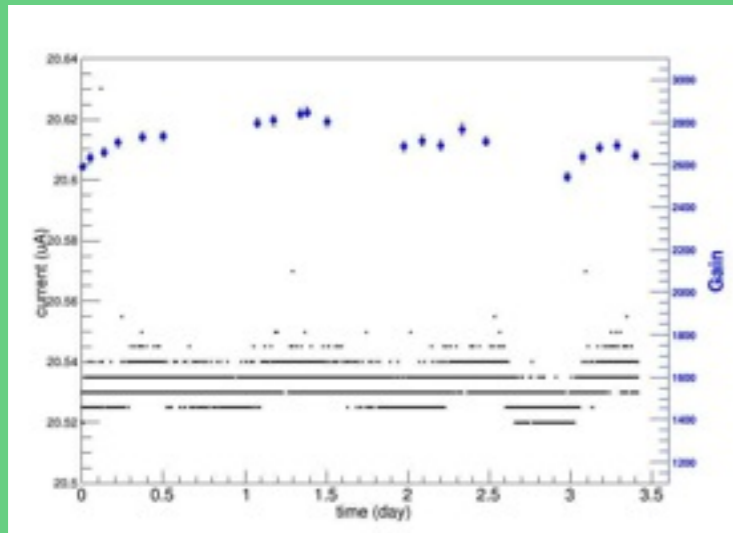

low gain

Raytech

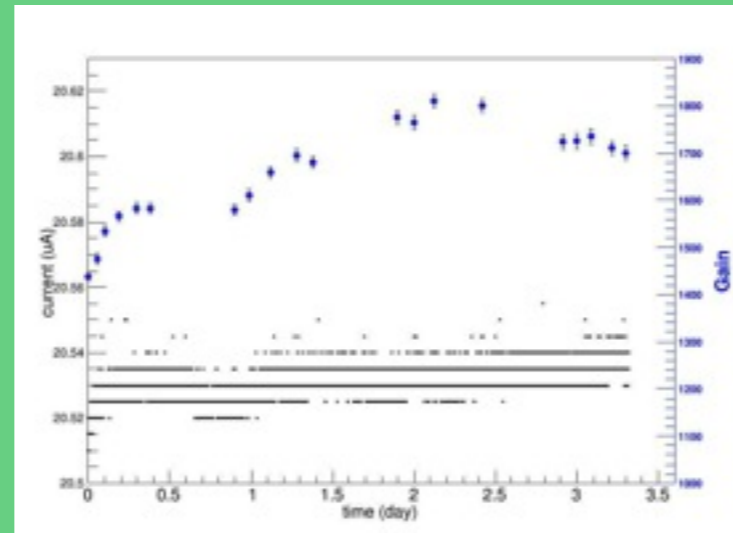

low gain

Scienergy

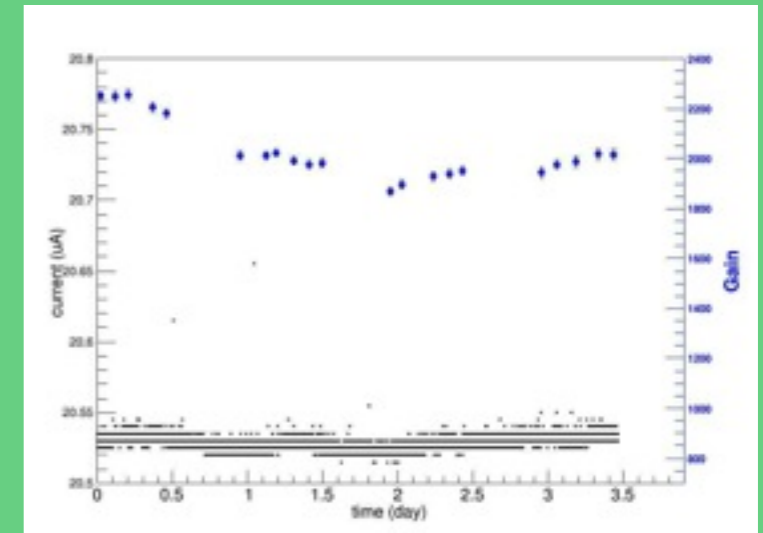

low gain

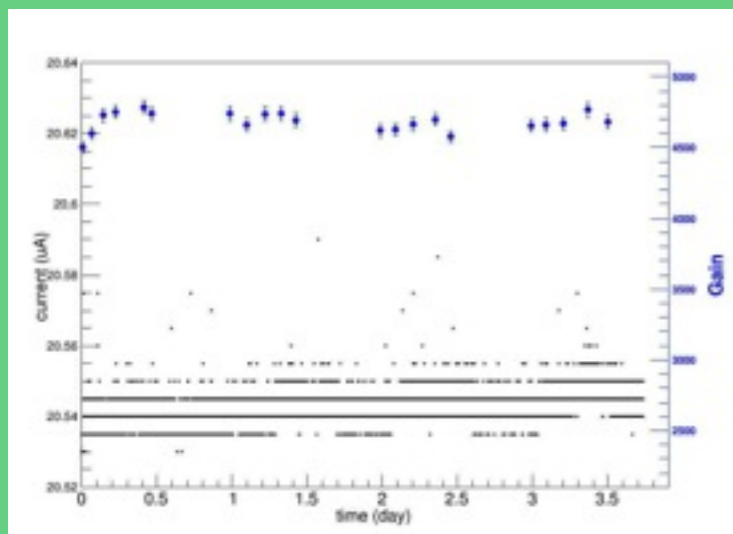

high gain

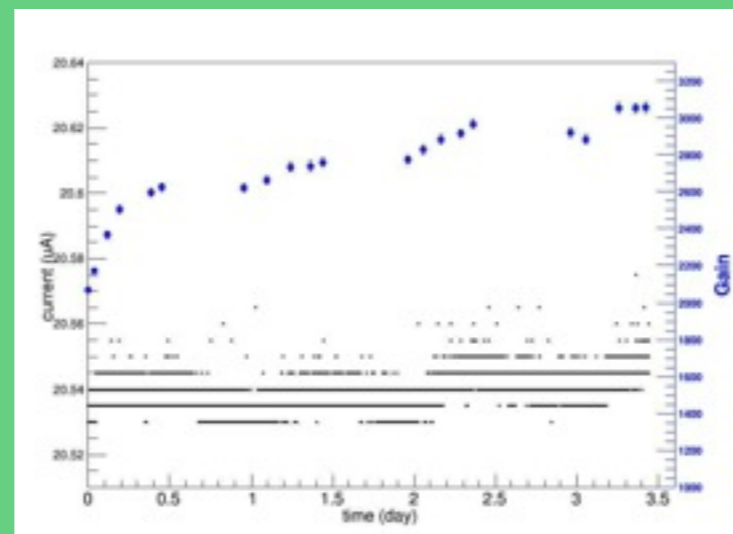

high gain

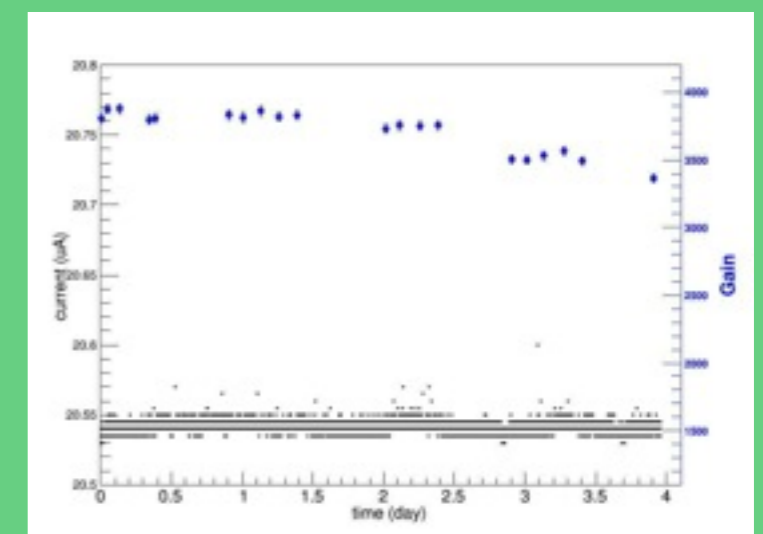

high gain

Results of measurements (50um GEM)

(Gain and H₂O contamination)

CERN

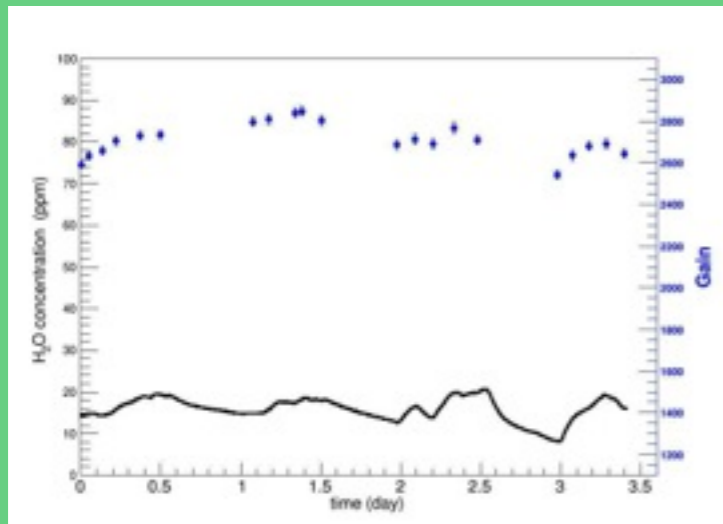

low gain

Raytech

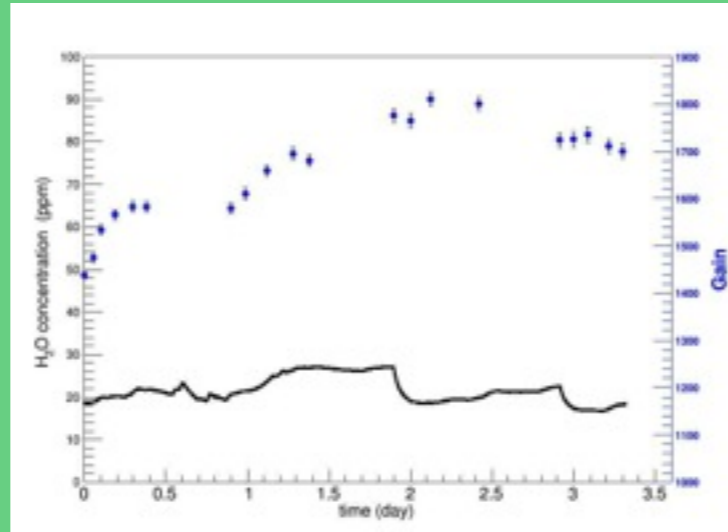

low gain

Scienergy

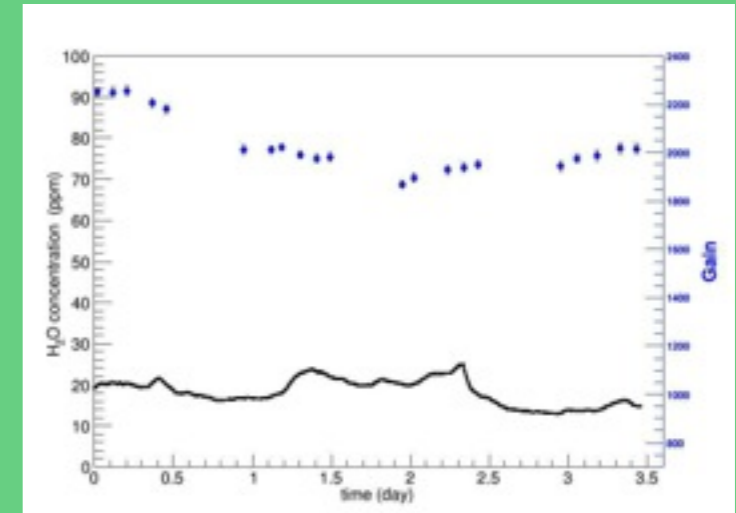

low gain

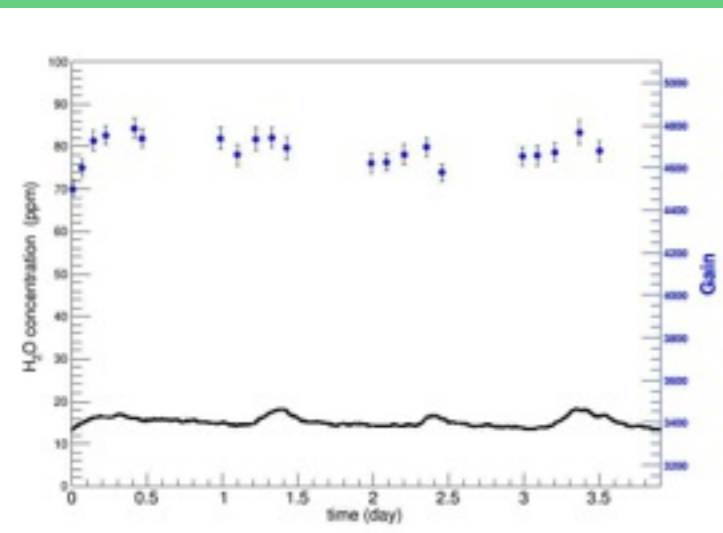

high gain

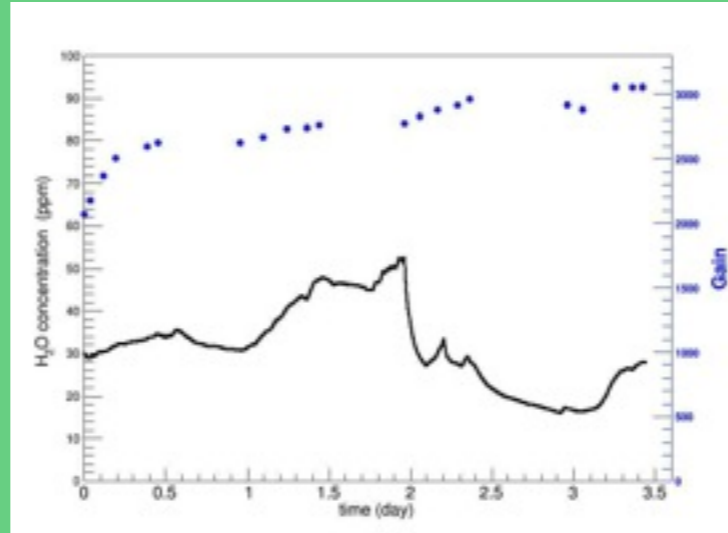

high gain

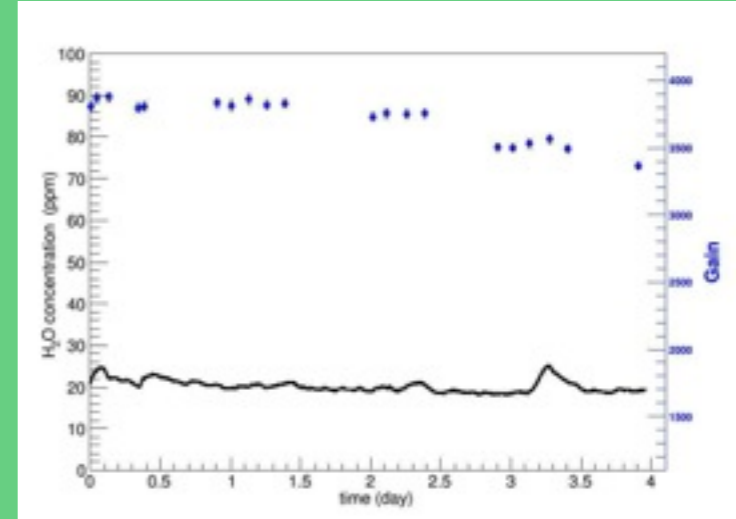

high gain

Results of discharge rate (50 um GEM)

Results of discharge rate (50 um GEM)

Type (production)	CERN (chem. etching)		Raytech (chem. etching)		Scienergy (laser etching)	
V	230	240	230	240	230	240
V	230	240	230	240	230	240
V	230	230	230	230	230	230
Gain	2710	4680	1660	2720	2030	3710
Rate (X10)	3.4 ± 1.1	7.1 ± 1.5	3.1 ± 1.1	5.7 ± 1.4	2.7 ± 1.0	3.8 ± 1.1

- There is no difference between the production type
- Higher gain leads high discharge rate

Results of measurements (100um GEM)

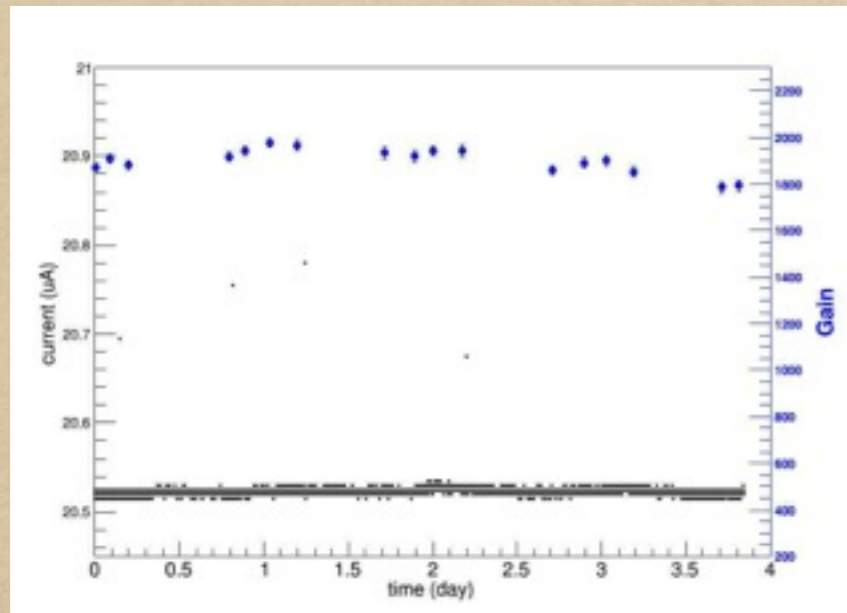

$V_{GEM1}=355V, V_{GEM2}=330V$

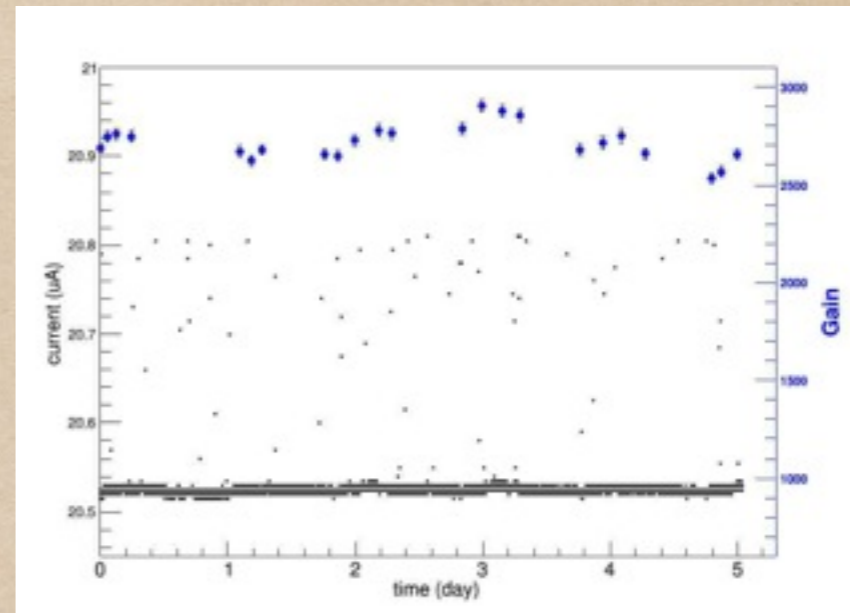

$V_{GEM1}=355V, V_{GEM2}=340V$

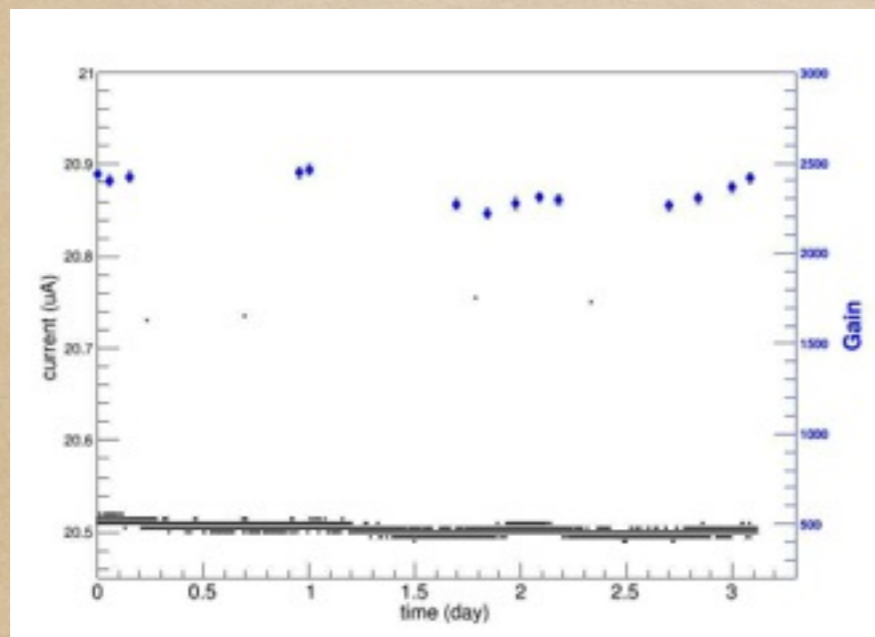

$V_{GEM1}=360V, V_{GEM2}=330V$

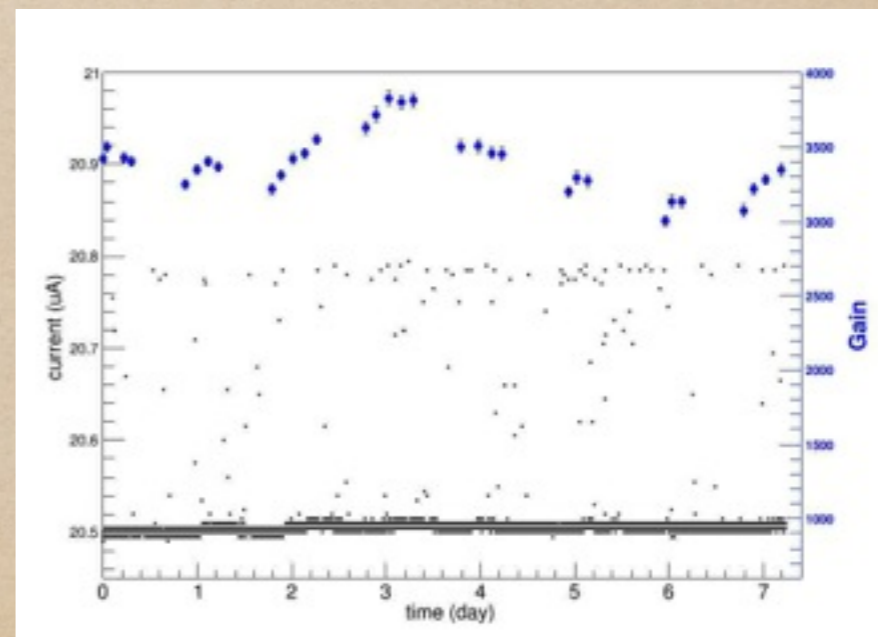

$V_{GEM1}=360V, V_{GEM2}=340V$

Discharge measurement with water contamination

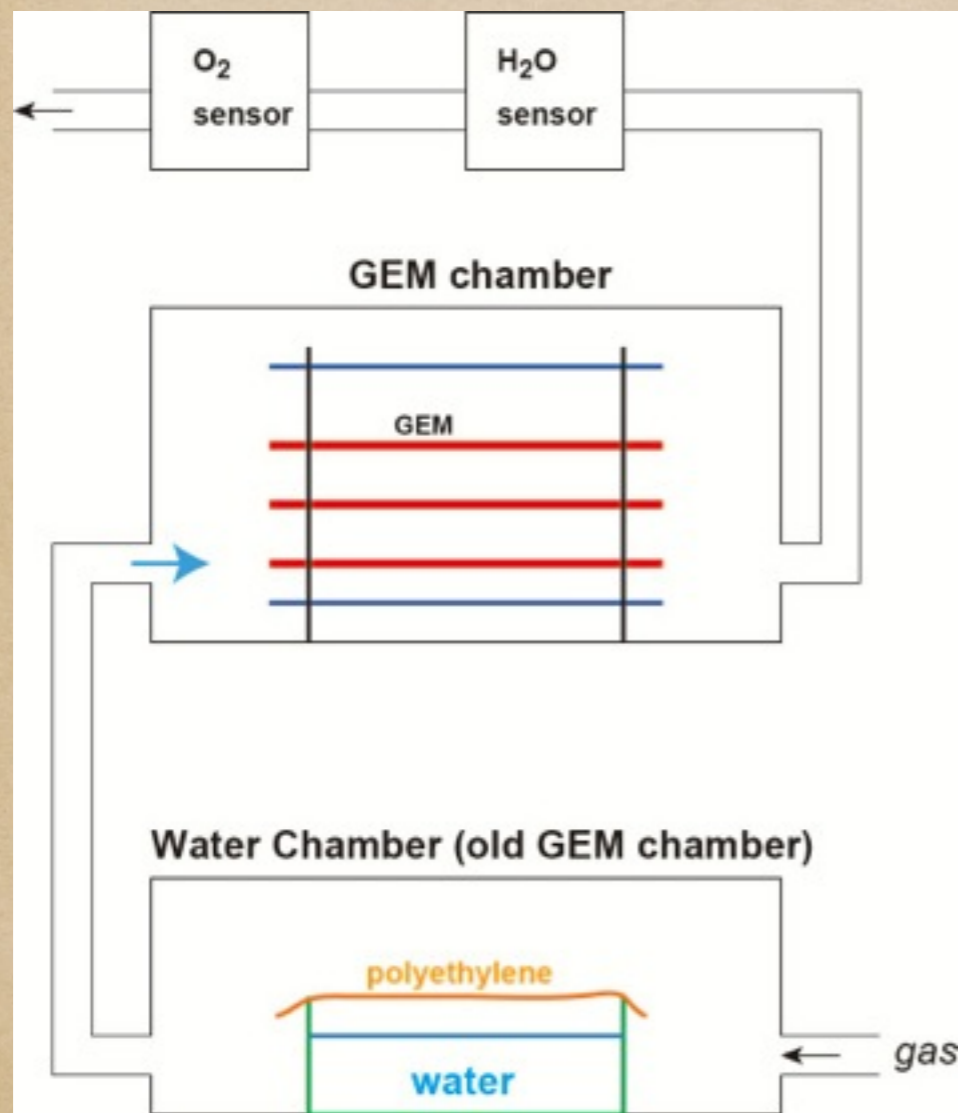

Setup of measurement

- Water is put in the plastic box.
- The top of the box is covered by polyethylene sheet.
- Water can pass through the sheet by degrees.



- ✓ The rate of contamination can be stable for long time.
- ✓ But the rate can't be controlled.

Results of measurements (100um GEM)

$$V_{\text{GEM1}} = 355\text{V}, V_{\text{GEM2}} = 340\text{V}$$

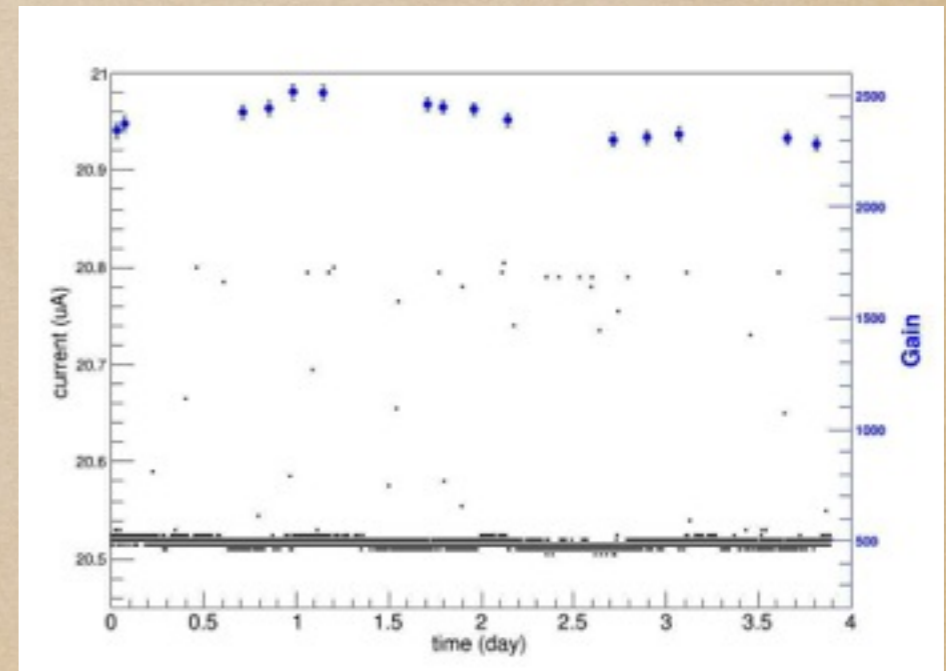
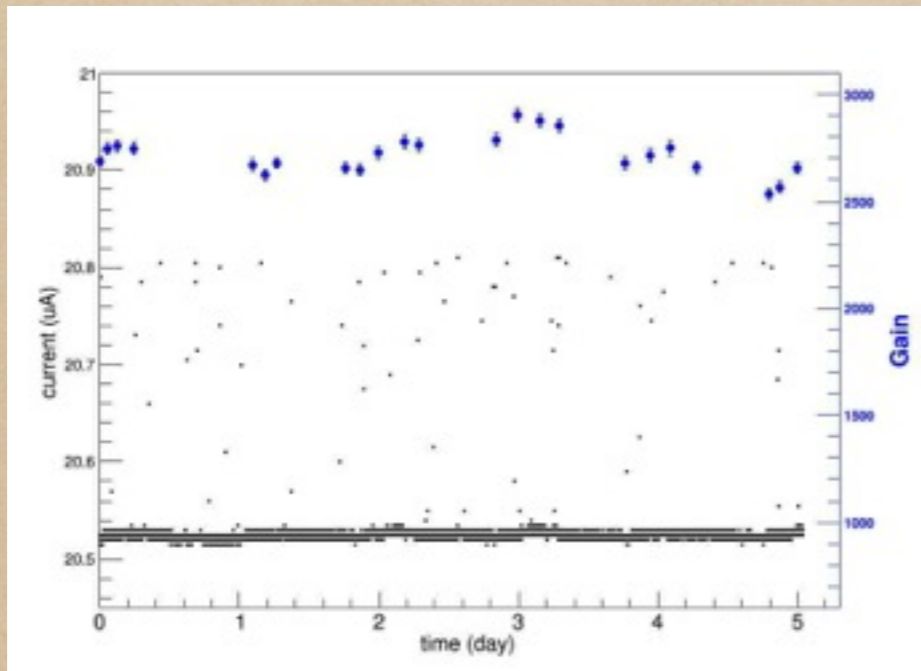
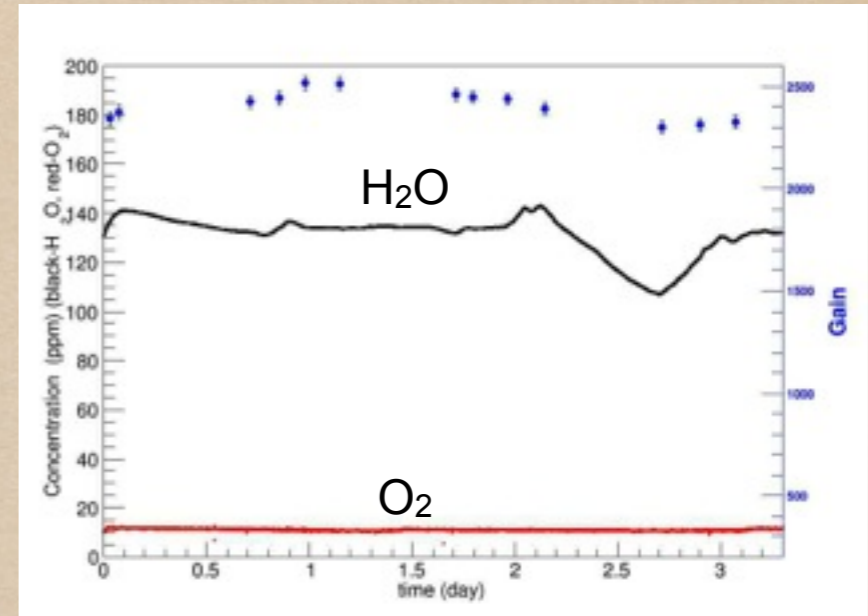
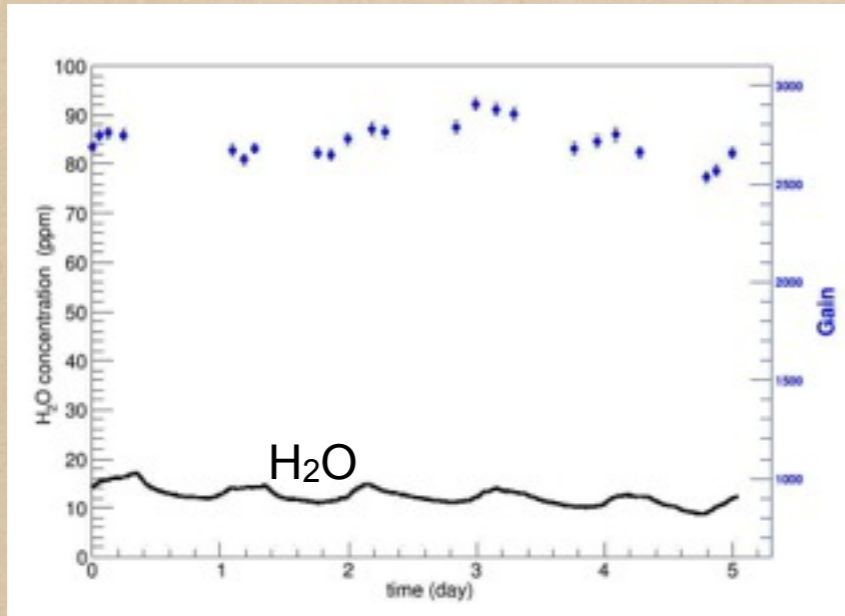

without contamination
(around 12 ppm)

with contamination
(around 130 ppm)

Results of discharge rate (100um GEM)

Results of discharge rate (100um GEM)

V	355 (LP1)							360	
V	330 (LP1)		335		340			330	340
H	19	11	12	160	13	21	132	9	13
Gain	1890	1900	2020	1912	2720	2600	2390	2350	3400
Rate (X10)	0.3±0.3	1.2±0.6	2.6±0.9	1.7±0.7	14.0±1.8	7.5±1.6	11.0±1.9	1.5±0.8	17.7±1.7

- Discharge rate at low gain is almost same as 50um GEM.
- Applying the high voltage to GEM2 leads a increase of the rate. (GEM2 is likely to discharge)
- We can't find the relation between discharge rate and H₂O.

Summary and Plan

- ✓ Micro discharge of GEM causes the gain drop. In the TestBeam at DESY, our 100um GEM has been happened the discharge frequently. But DESY GEM (made by CERN) has not been happened discharge.
- ✓ We measured the discharge rate of various types of GEM under the controlled environment.
- ✓ As for 50um thick GEM, there is no remarkable difference of the discharge rate between 3 types of GEM.
- ✓ As for 100um thick GEM, the discharge rate of low gain is almost same as 50um thick GEM.
- ✓ It can't be said that the H₂O contamination influences the discharge rate.
- ✓ The long term measurement is in progress.