

ILC e- injector

All units in cm

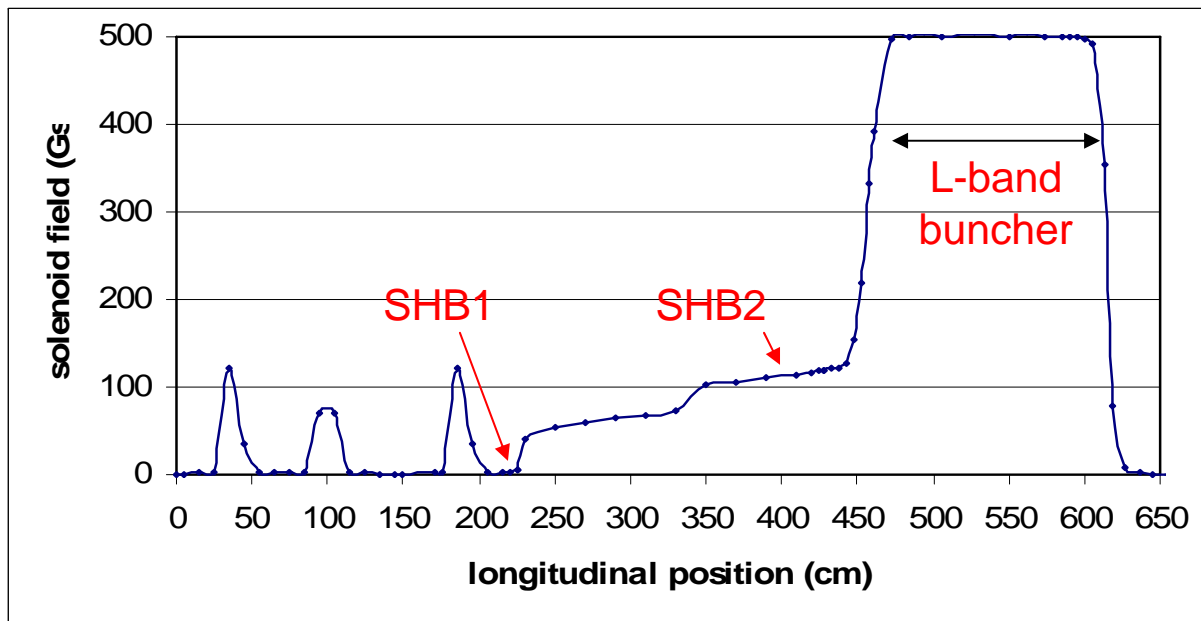

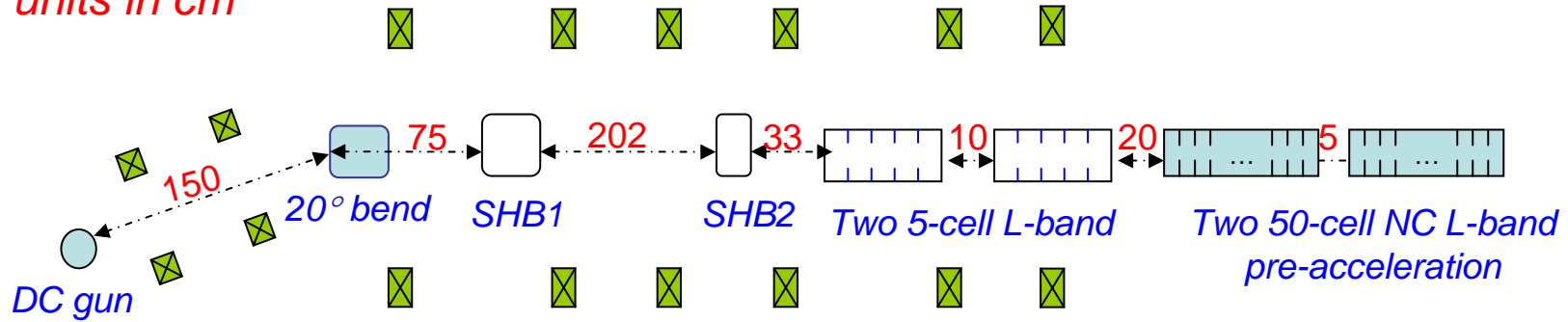

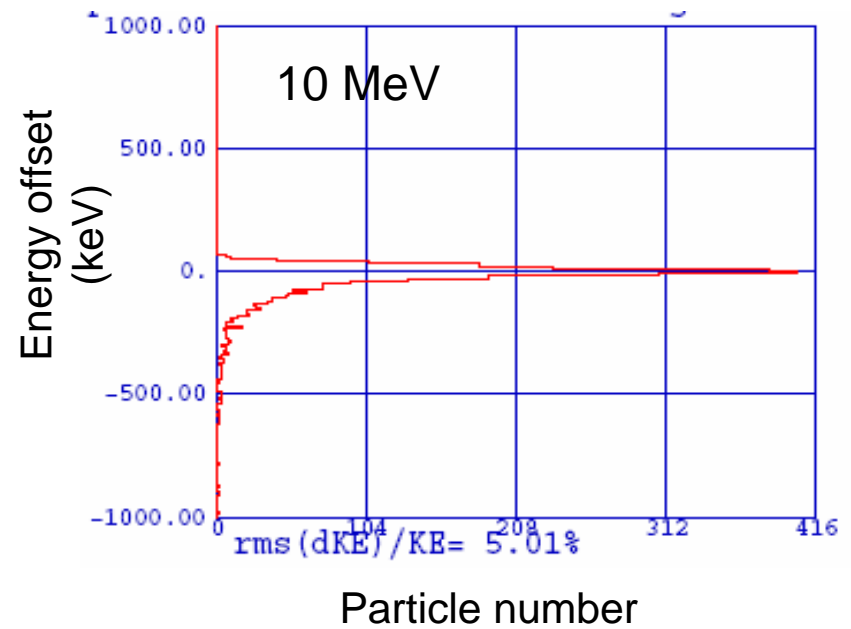
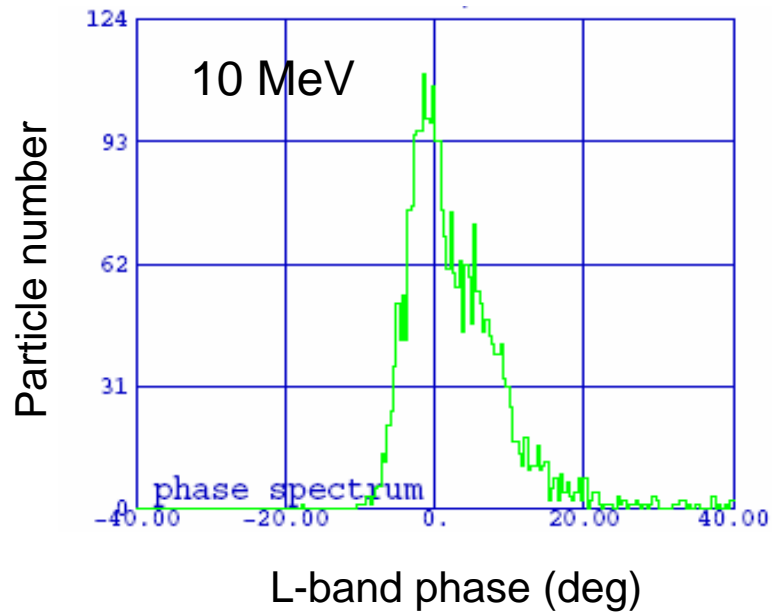
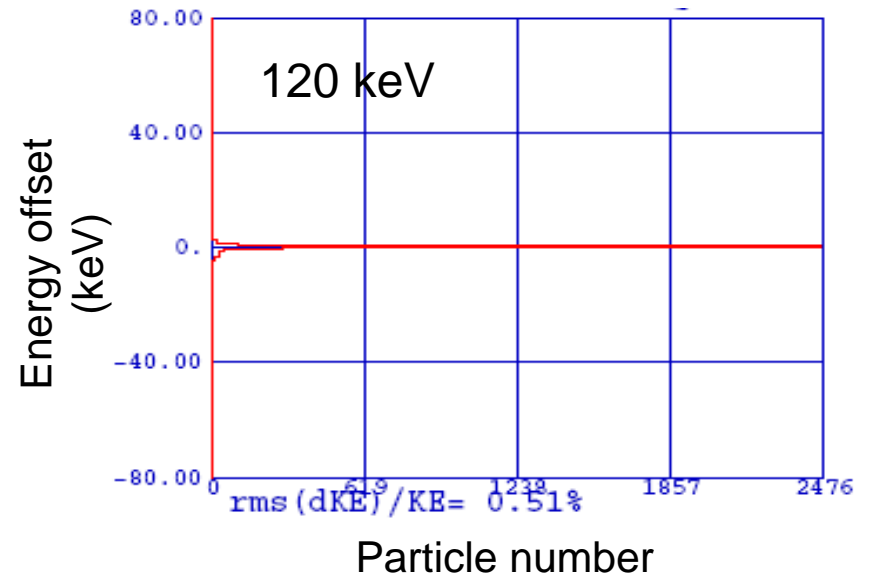
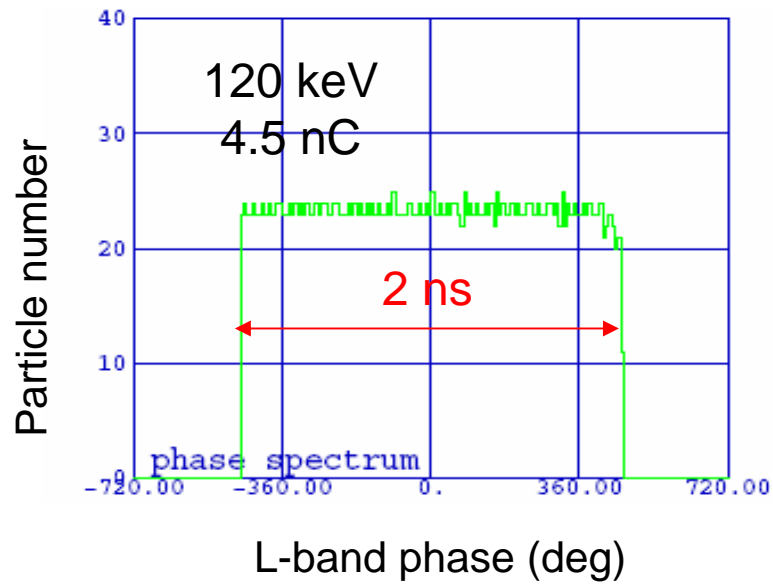
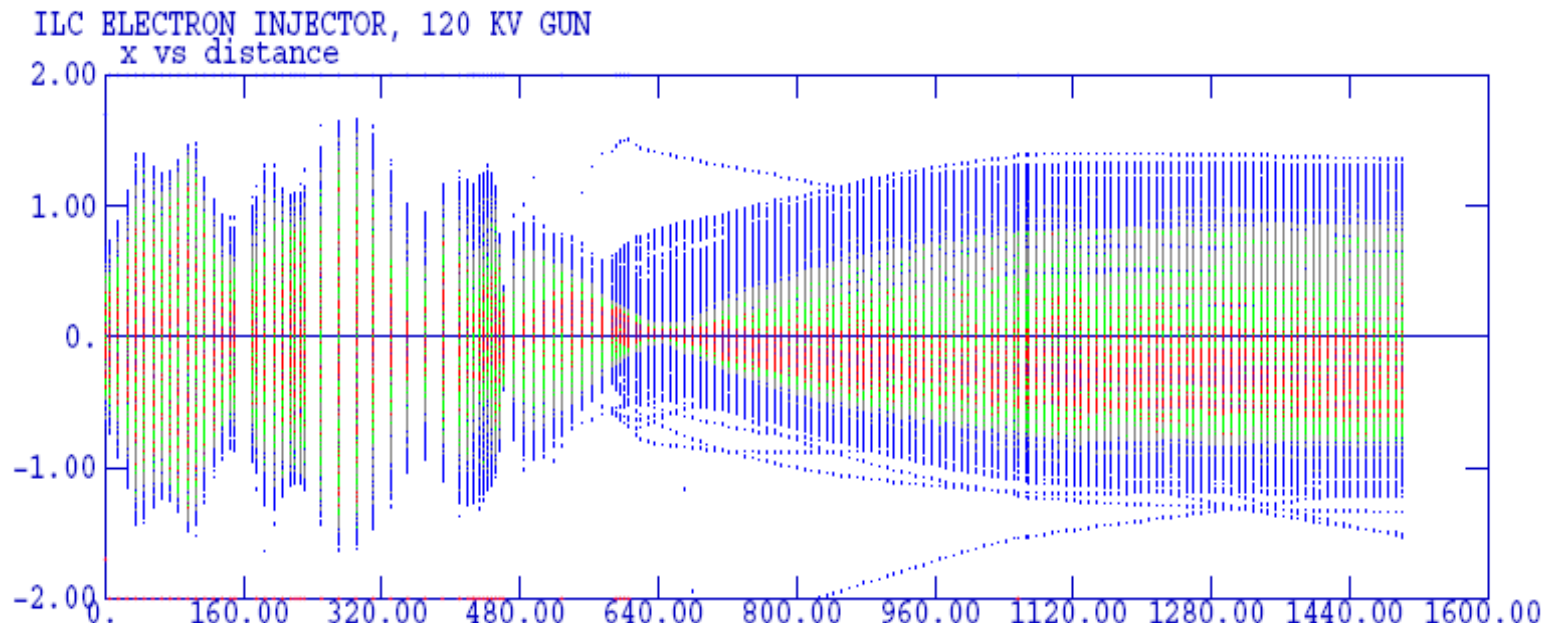
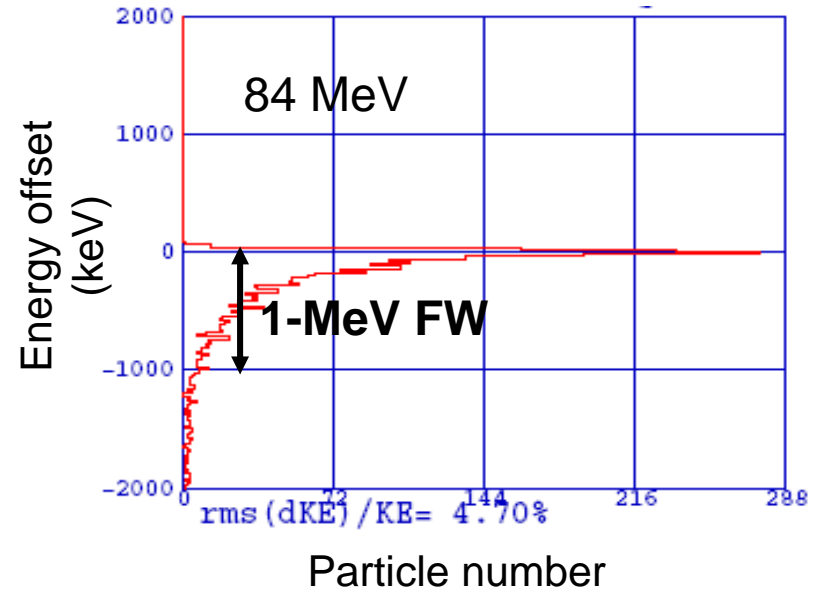
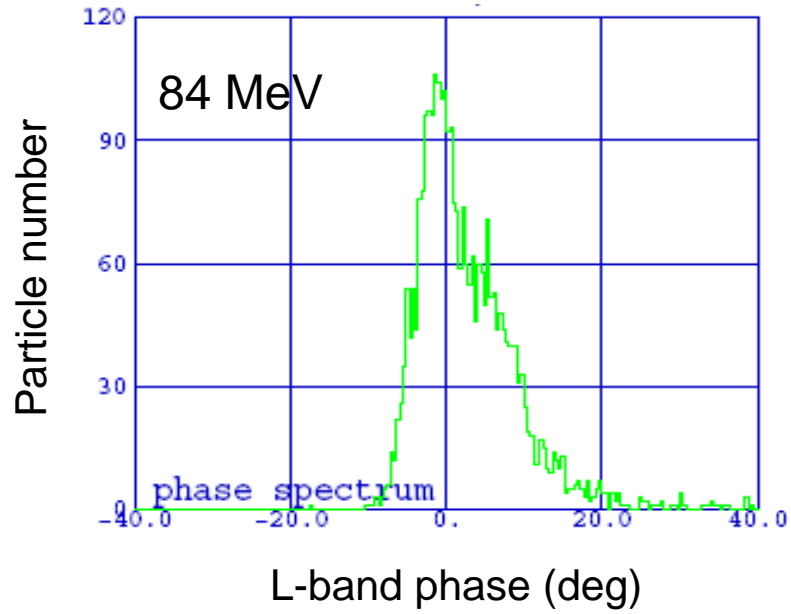

Summary

Charge: *4.5 nC (gun exit)*
4.1 nC (84 MeV) with window: 1-MeV Full energy spread and 52-ps full length

Required charge: *3.2 nC at the end of e- source*

Emittance: *50 microns without window*

Energy: *84 MeV*