

Beam Instrumentation

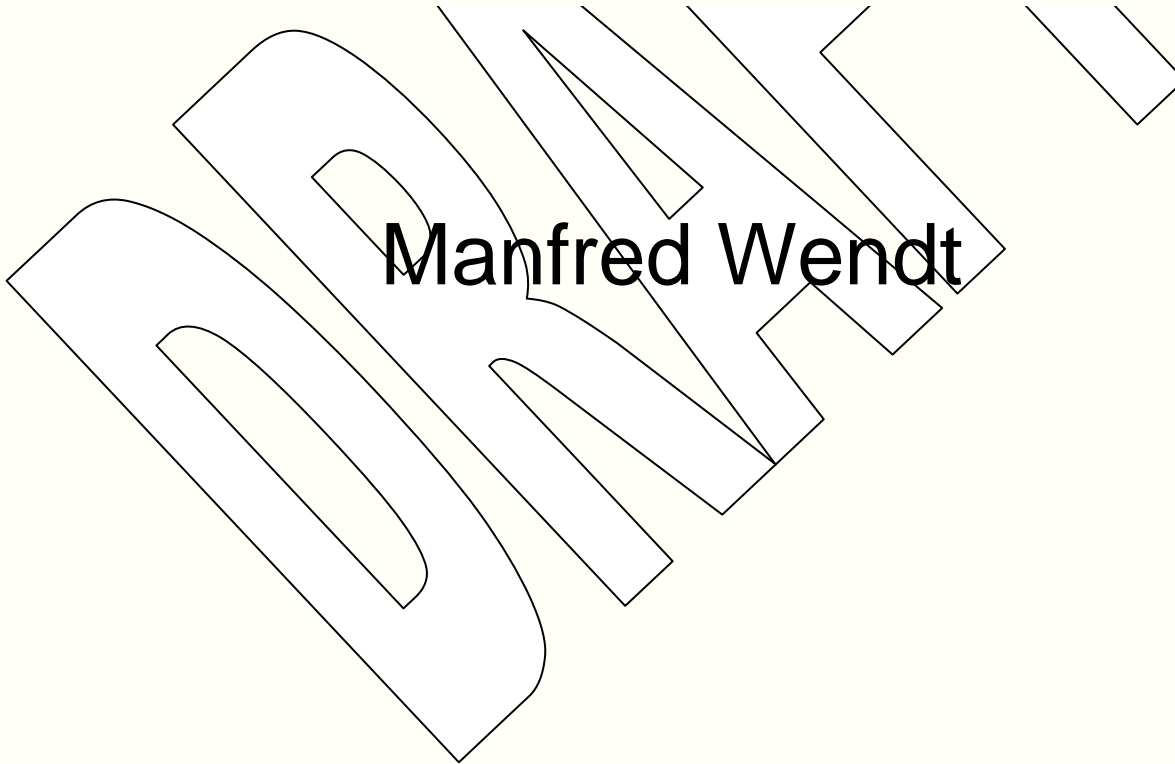

Manfred Wendt



- **Motivation**
- **NML Beam Instrumentation**
 - **Beam-line Overview**
 - **List of required Beam Monitors**
- **Beam Instrumentation Examples:**
 - **Cold Cavity-BPM**
 - **HOM Coupler Signal Processing**
- **Cost Estimation**
- **Conclusion**

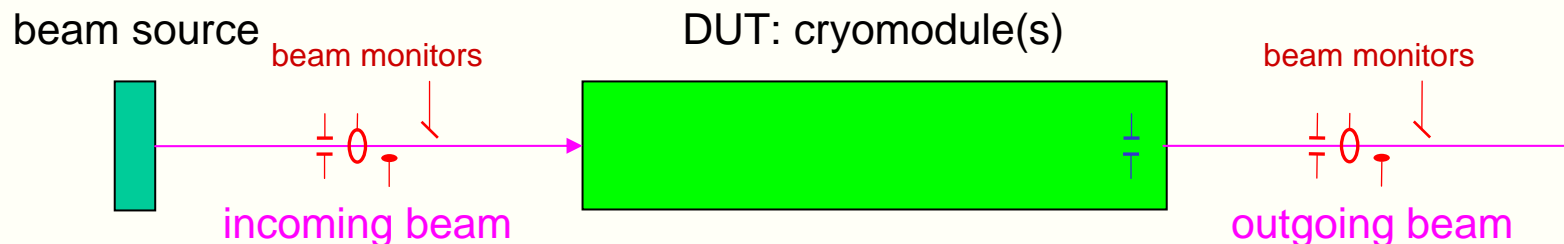

- **Characterization of the SCRF cryomodule(s) under realistic ILC-like beam conditions:**
 - Using the beam as a “test instrument”.
 - Beam instrumentation is used to monitor and compare upstream and downstream beam conditions.
 - Additional beam monitoring uses HOM-coupler and cold-BPM signals of the cryomodule itself.
- Beam monitors are used to characterize the beam, e.g. orbit, bunch charge, emittance, bunch length, energy, jitter, phase, etc., in order to understand sources of RF-noise, cavity misalignment, phase mismatch, and other imperfections.
- The development of a cold cavity-BPM, which is part of the cryomodule, is essential for the low-emittance beam transport.



NML Beam Instrumentation (cont.)



Fermilab

- **Preliminary list of required beam instrumentation:**
 - 5x toroids for bunch charge measurements.
 - ~ 20x BPM's for beam position / orbit measurements, also for beam (bunch) energy, optics and many other topics, including:
 - A cold cavity-BPM for the cryomodule (1 μm single bunch resolution)
 - A “perpendicular” stripline-BPM with EOM-based optical sampler read-out in the flat chamber of the bunch compressor (for bunch energy and horizontal position detection)
 - 4x time-of-flight (TOF) or phase monitors.
 - ~ 20x screen monitors for beam emittance, transverse particle distribution, dark current detection, etc. (OTR, YaG, slits,...).
 - Several beam monitors for bunch-length measurements (interferometer-based, RF-based, EOS-based,...).
 - HOM-coupler signal processing system.
 - A BLM-based machine protection system (MPS).
 - An ATCA-based read-out system for BPM's and toroids.
 - An EOS-based bunch-length monitor, and some other advanced beam monitors.
- **Most beam monitors need to time resolve single bunch information (< 300 ns measurement / integration time).**
- **Some beam monitor can be reused from the NICADD A0-Photoinjector project, but most needs to be designed and build.**

- **Requirements**
 - Real estate: ~ 170 mm length, 78 mm aperture.
 - Cryogenic environment (2...10 K).
 - Cleanroom class 100 certification.
 - UHV certification.
 - < 1 μm single bunch resolution (< 300 ns measurement time).
 - < 200 μm error between electrical BPM center and magnetic center of the quad.
- **Waveguide-loaded, “CM-free” cavity-BPM:**
 - Waveguide-loaded pillbox with slot coupling.
 - Dimensioning for f_{010} and f_{110} symmetric to f_{RF} ,
 $f_{\text{RF}} = 1.3 \text{ GHz}$, $f_{010} \approx 1.1 \text{ GHz}$, $f_{110} \approx 1.5 \text{ GHz}$.
 - Dipole- and monopole ports, no reference cavity for intensity signal normalization and signal phase (sign).
 - $Q_{\text{load}} \approx 600$ (~ 10 % cross-talk at 300 ns bunch-to-bunch spacing).
 - Minimization of the X-Y cross-talk (dimple tuning).
 - Simple (cleanable) mechanics.

Window –
 Ceramic brick of alumina 96%
 $\mu_r \approx 9.4$
 Size: the same as slot

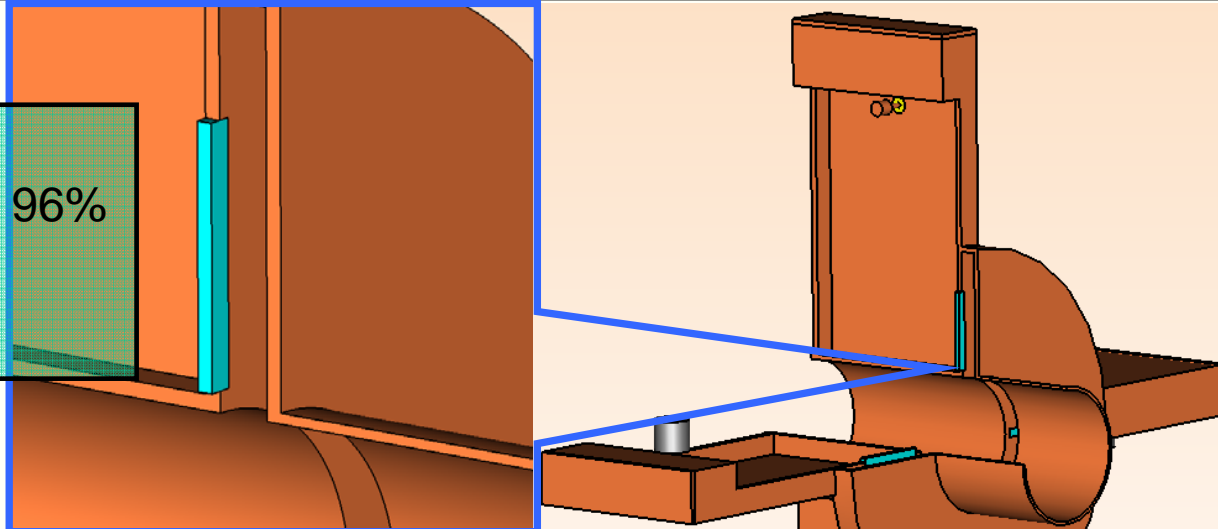

Frequency, GHz	1.46
Loaded Q	~ 600
Beam pipe radius, mm	39
Cell radius, mm	114
Cell gap, mm	10
Waveguide, mm	122x110x25
Coupling slot, mm	47x5x3

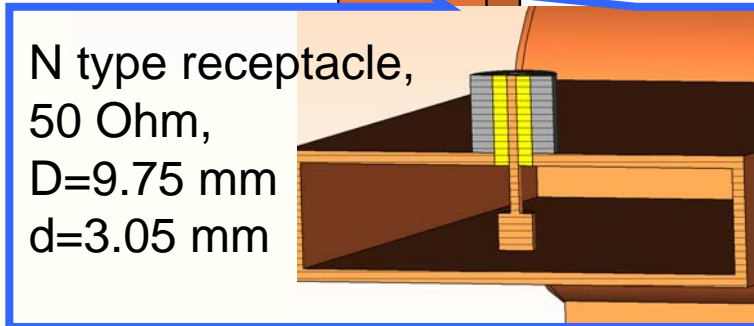



Cold Cavity-BPM: Resolution Limit



$$V_{110}(x) = x \cdot \pi f_{110} \sqrt{Z_0 \left(\frac{1}{Q_\ell} - \frac{1}{Q_0} \right) \left(\frac{R_{sh}}{Q} \right)_{110}^{\delta x}} \frac{q}{\delta x}$$

$$V_{110}(x) = x \cdot 4.145 \cdot 10^3 \text{ V} / nC$$

$$V_{110} \approx 4 \text{ mV} / nC \mu m$$

$$V_{ThermalNoise} = \sqrt{Z_0 k T BW} \approx 0.7 \mu V$$

with: $f_{110}(x) = 1.46 \text{ GHz}$

$$Z_0 = 50 \Omega$$

$$Q_\ell \approx 600$$

$$Q_0 \approx 2000$$

$$\left(\frac{R_{sh}}{Q} \right)_{110}^{\delta x=1mm} = 14 \Omega$$

$$q = 1 nC$$

with: $Z_0 = 50 \Omega$

$$k = 1.38 \cdot 10^{-23} \text{ J} / K$$

$$T \approx 300 \text{ K}$$

$$BW = \frac{f_{110}}{Q_{\ell 110}} \approx 2.4 \text{ MHz}$$

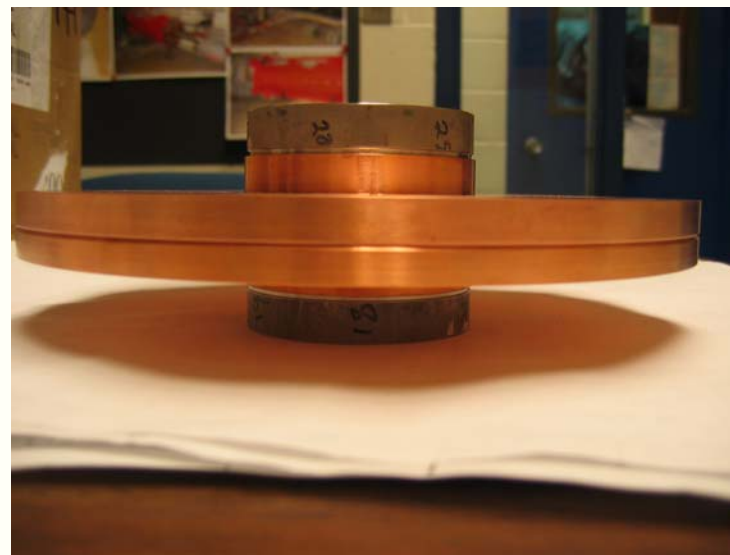

Cold Cavity-BPM: Layout

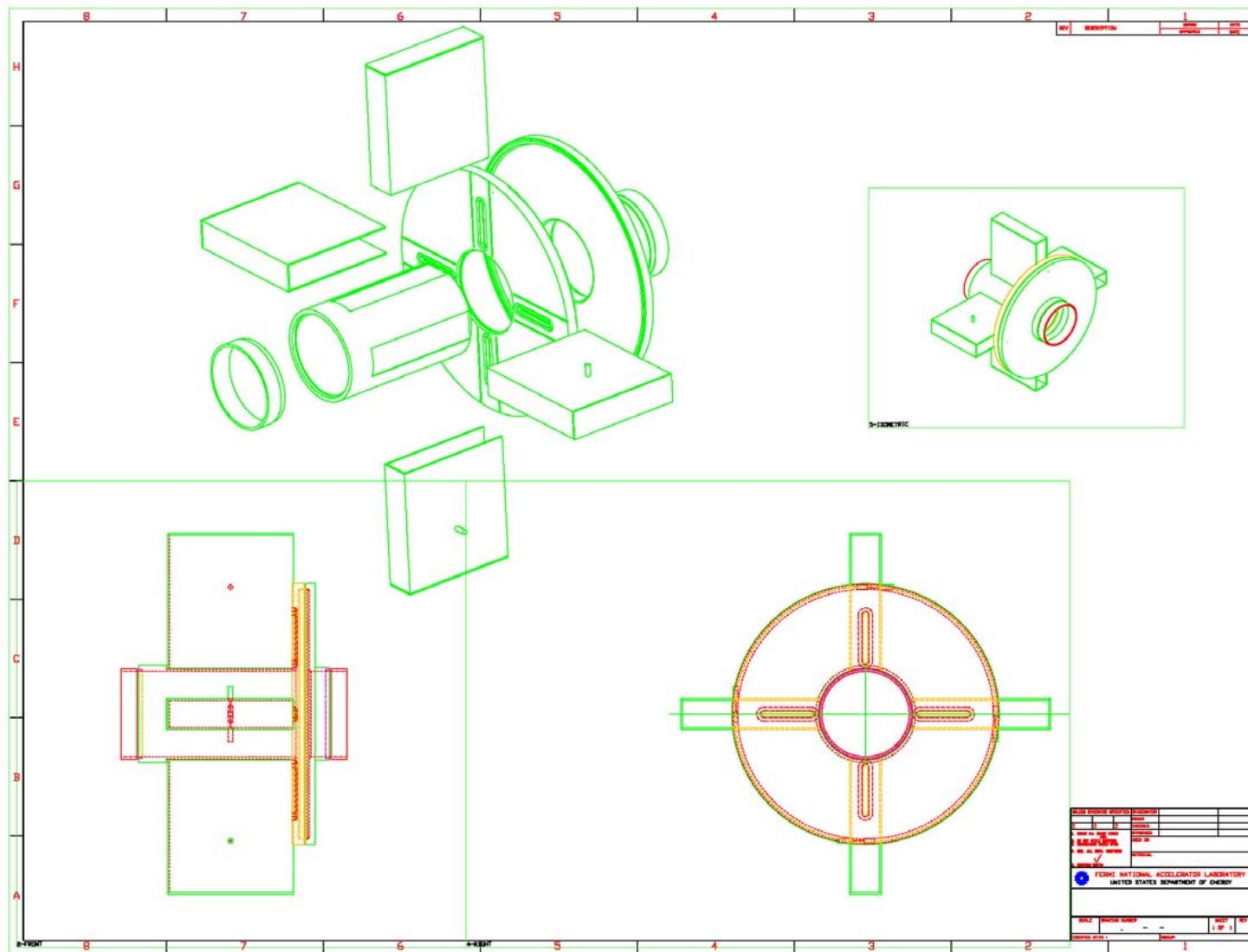

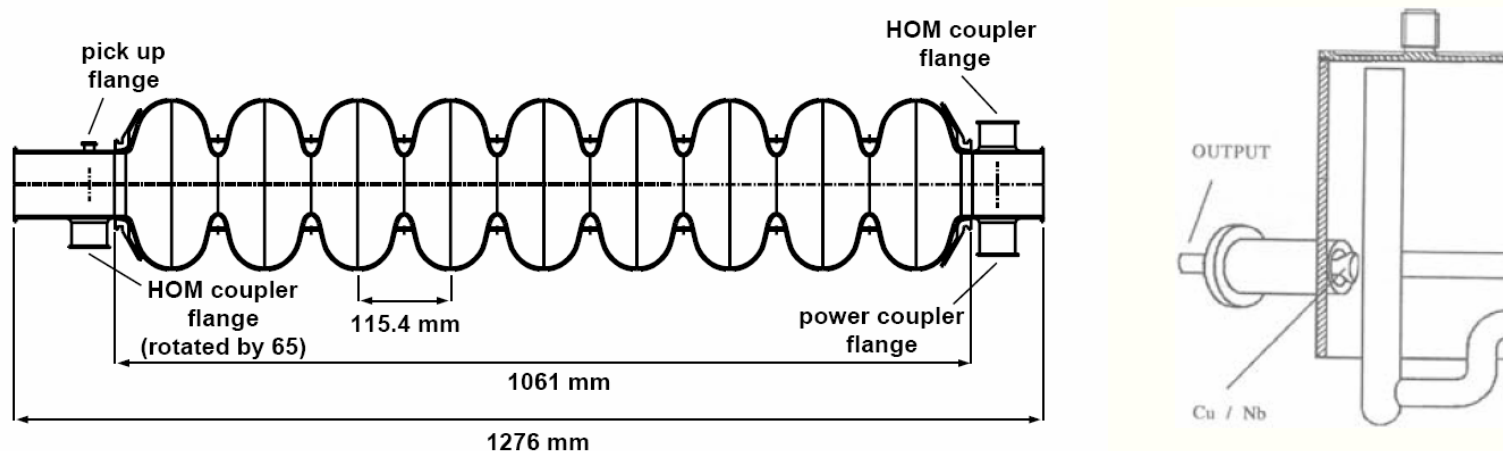

HOM coupler signals can be used for (narrowband):

- **Beam Position Monitoring**
 - Dipole mode analysis of both polarizations.
 - Requires beam-based calibration data, to orthogonalize the polarization planes of the excited eigenmodes per SVD algorithm.
- **Beam Phase Monitoring**
 - Comparison of the leaking 1.3 GHz fundamental (TM_{010}) to the first monopole HOM (TM_{011}) on the same signal cable!
 - The method cannot resolve bunch-by-bunch phase information.

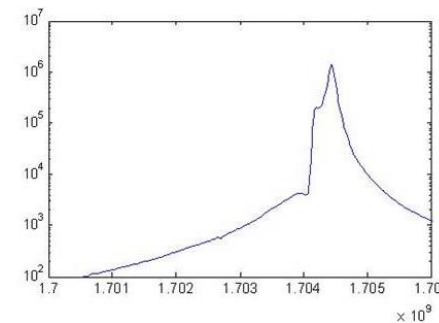
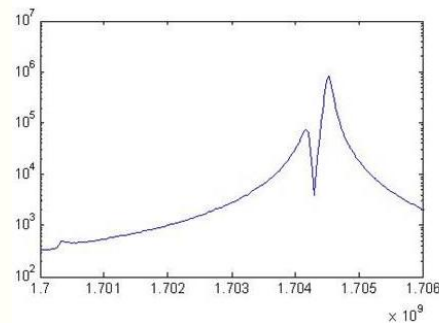
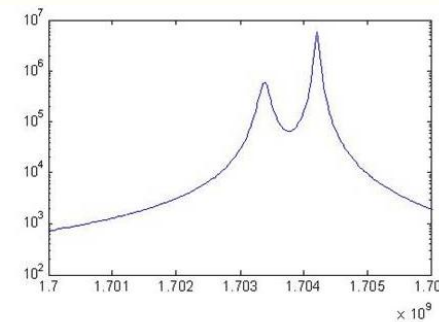
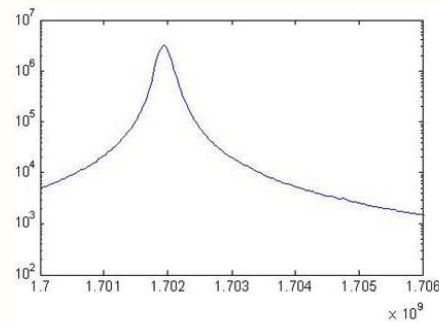
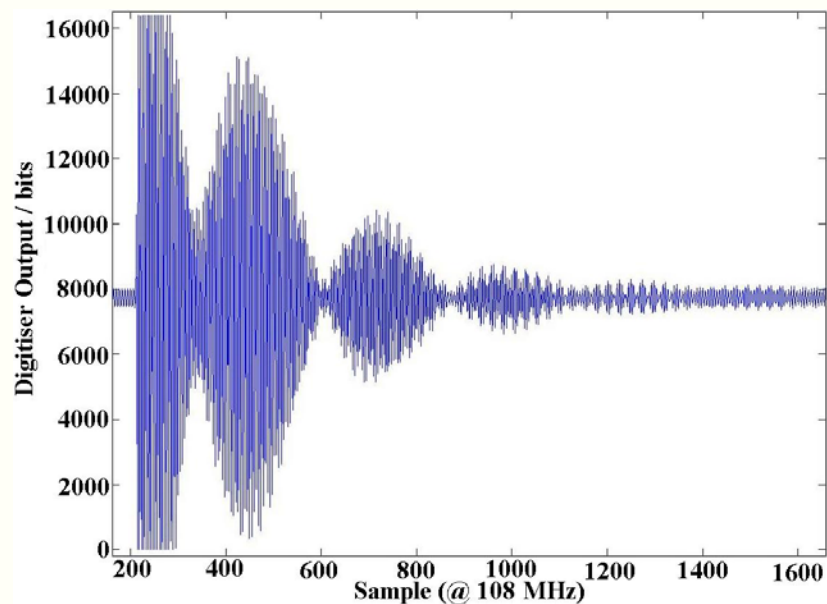

- HOM coupler waveforms of a dipole mode in time- and frequency domain.
- The polarization frequencies are not always well separated!
- The alignment of the polarization axes is due to cavity imperfections, coupler structures, etc. and may be even twisted.

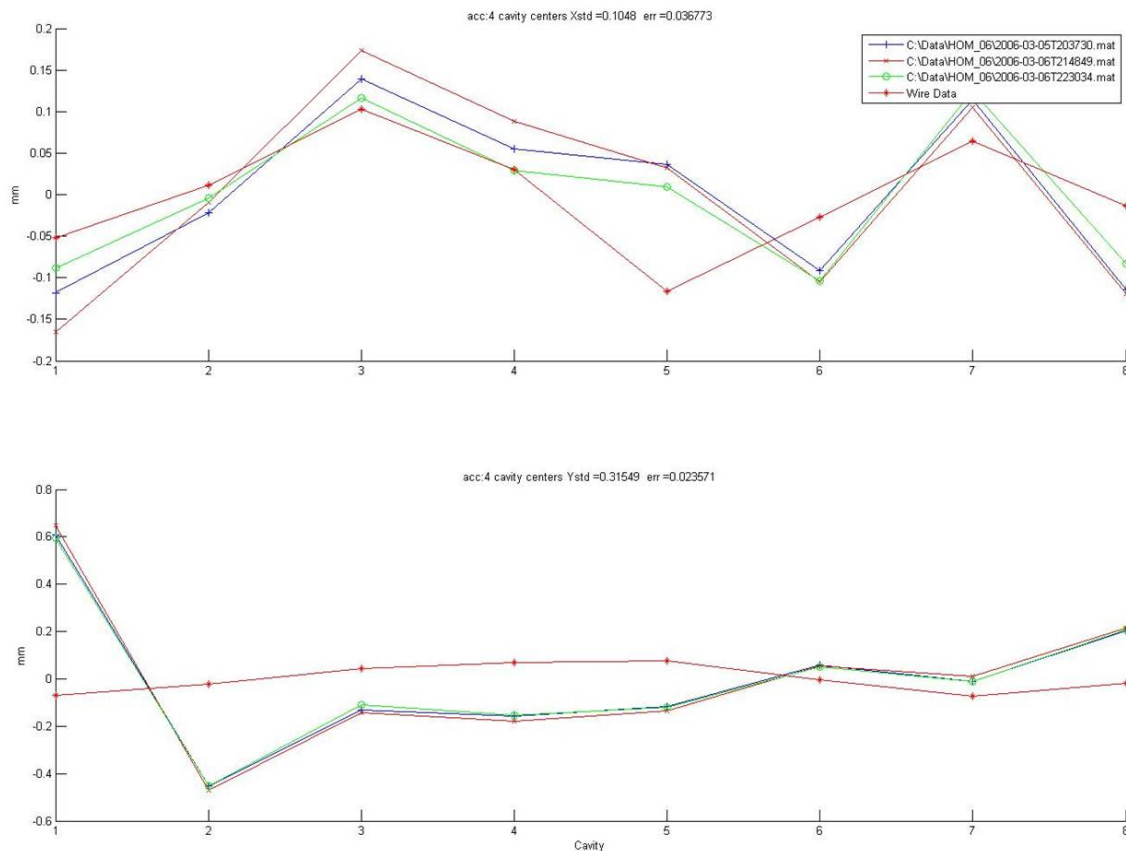

- TTF results of ACC4 cavity alignment
- Narrowband read-out of the TE_{111-6} mode
- Resolution: $< 10 \mu\text{m}$

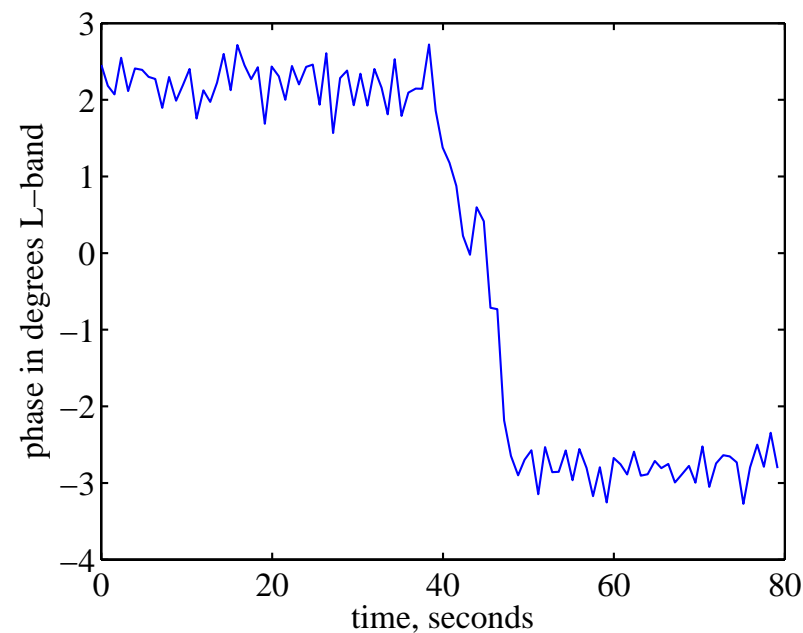
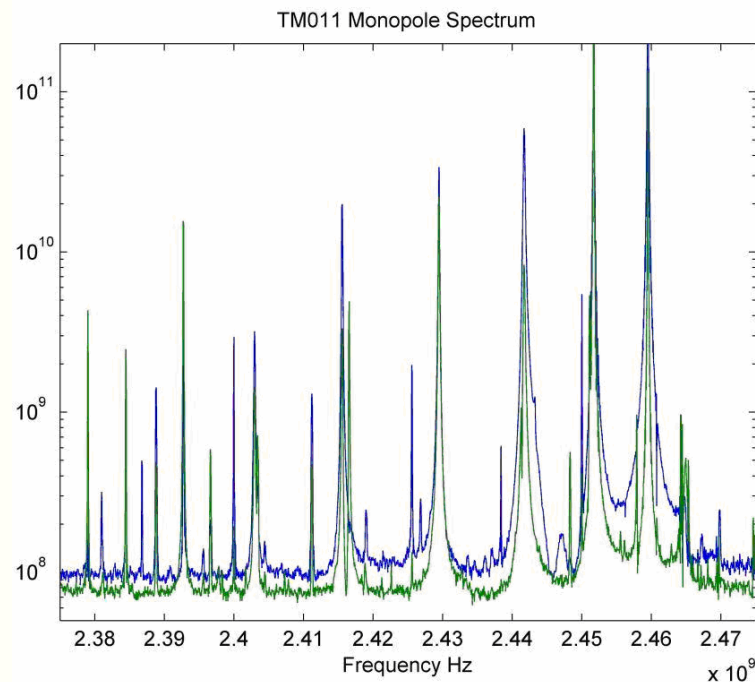

Broadband HOM monopole measurements (TTF):

- Broadband, oscilloscope-based (2.5 GHz) data acquisition.
- 5 degree phase change set through the LLRF.
- Noise (~ 170 fs RMS) is equivalent to 0.08 degrees at 1.3 GHz.



Cost Estimation



NML Beam Instrument	M&S (k\$)	SWF
Toroids	50	
BPM's	150	
TOF & Beam Phase (EOM-based)	120	
Screen Monitors	150	
HOM Signal Processing	70	
BLM's	50	
Read-out Electronics	200	
Advanced Beam Monitor Dev., e.g. EOS	150	
Tools (scope, software, RF equipment)	200	
Grand Total	1140	

- **Beam monitors and instrumentation costs can be staged: Start with basic monitors, i.e. toroids, BPM's, screens; continue with more advanced beam monitors...**
- **Beam instrumentation always is under continuing development, more funds will be required in the long run!**
- **SCRF Instrumentation has to cover also other areas, e.g. test stands, HINS, protection systems, etc., therefore additional funds may be required!**
- **Costs for the required infrastructure (racks, crates, cabling, controllers, patch cables and panels, power supplies, A/C, etc.) are NOT in this costing scope.**

- **The beam instrumentation is used to test the performance of the SCRF accelerating structures, and related systems under realistic beam conditions.**
- **Precise, high resolution measurement methods will detect (also quantitatively) sources of imperfections, misalignments, errors, etc.**
- **A beam-based validation of the SCRF systems gives the final confidence and proof of quality and understanding of the entire project!**

QUESTIONS