

1. Control Theory

Objective:

The course on control theory is concerned with the analysis and design of closed loop control systems.

Analysis:

Closed loop system is given \longrightarrow determine characteristics or behavior

Design:

Desired system characteristics or behavior are specified \longrightarrow configure or synthesize closed loop system

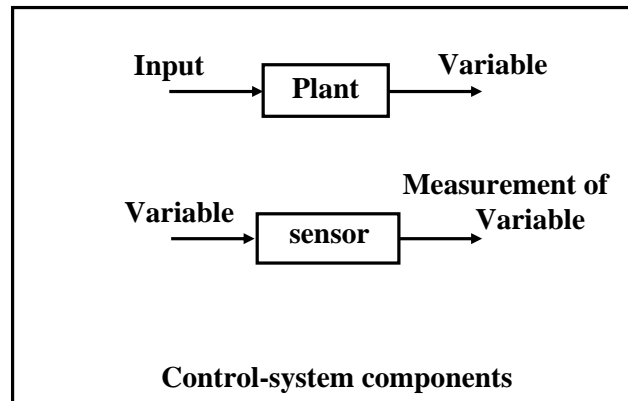

1. Introduction

Definition:

A closed-loop system is a system in which certain forces (we call these inputs) are determined, at least in part, by certain responses of the system (we call these outputs).

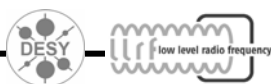
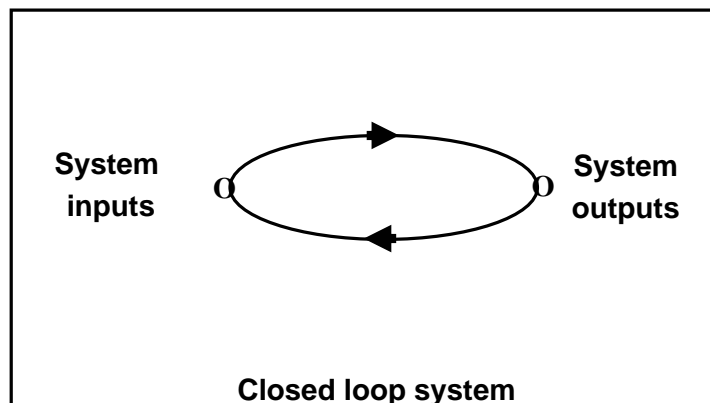

1.Introduction

Definitions:

- ❖ The system for measurement of a variable (or signal) is called a *sensor*.
- ❖ A *plant* of a control system is the part of the system to be controlled.
- ❖ The *compensator* (or controller or simply filter) provides satisfactory characteristics for the total system.

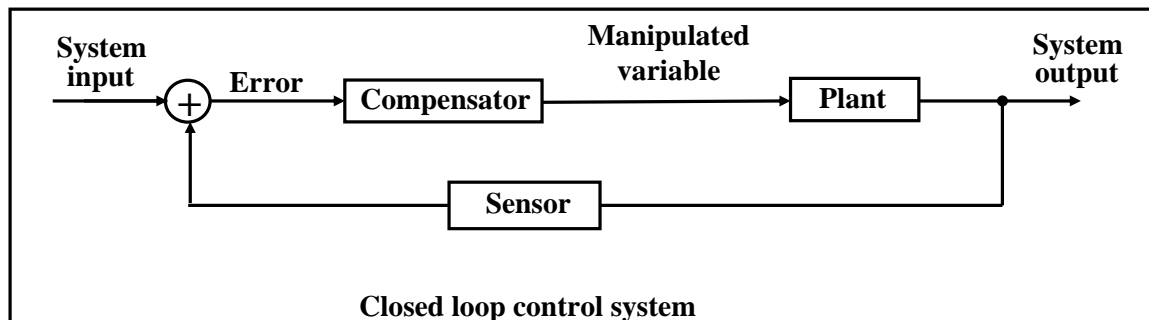

Two types of control systems:

- ❖ A *regulator* maintains a physical variable at some constant value in the presence of perturbances.
- ❖ A *servomechanism* describes a control system in which a physical variable is required to follow, or track some desired time function (originally applied in order to control a mechanical position or motion).

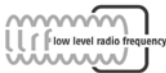

1.Introduction

Example 1: RF control system

Goal:

Maintain stable gradient and phase.

Solution:

Feedback for gradient amplitude and phase.

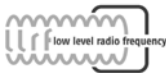
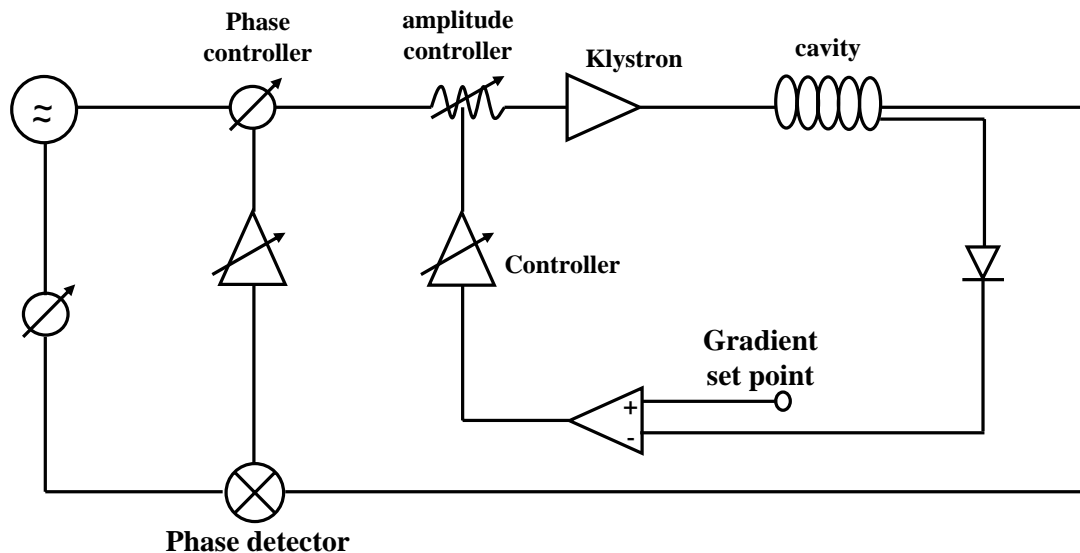

1.Introduction

Model:

Mathematical description of input-output relation of components combined with block diagram.

Amplitude loop (general form):

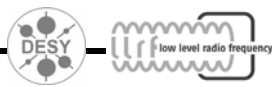
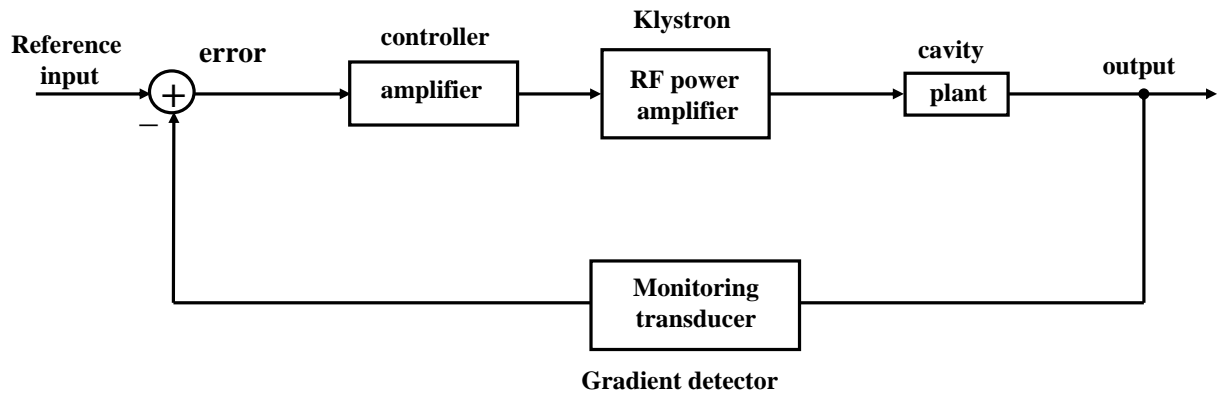

1.Introduction

RF control model using “transfer functions”

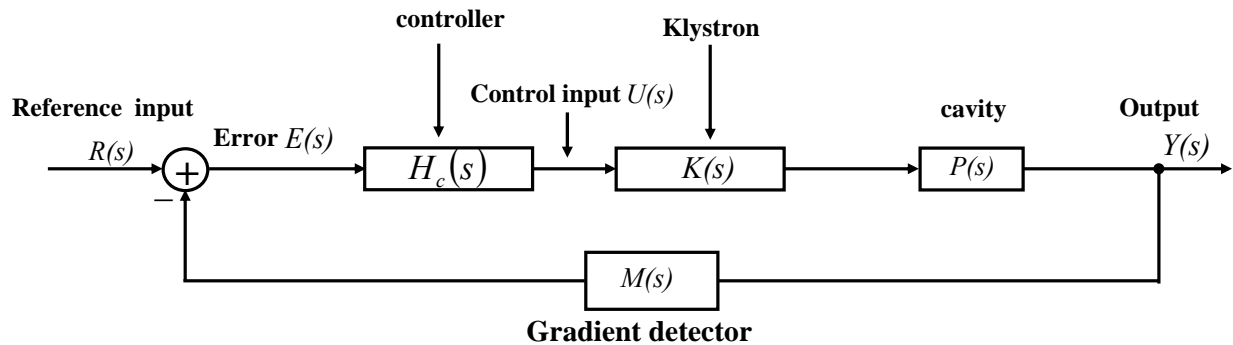

A transfer function of a **linear** system is defined as the ratio of the Laplace transform of the output and the Laplace transform of the input with I. C .’s =zero.

Input-Output Relations

Input	Output	Transfer Function
$U(s)$	$Y(s)$	$G(s) = P(s)K(s)$
$E(s)$	$Y(s)$	$L(s) = G(s)H_c(s)$
$R(s)$	$Y(s)$	$T(s) = (1 + L(s)M(s))^{-1} L(s)$

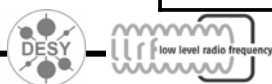

1.Introduction

Example2: Electrical circuit

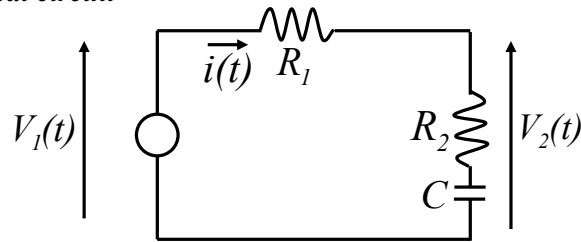

Differential equations:

$$R_1 i(t) + R_2 i(t) + \frac{1}{C} \int_0^t i(\tau) d\tau = v_1(t)$$

$$R_2 i(t) + \frac{1}{C} \int_0^t i(\tau) d\tau = v_2(t)$$

Laplace Transform:

$$R_1 I(s) + R_2 I(s) + \frac{1}{s \cdot C} I(s) = V_1(s)$$

$$R_2 I(s) + \frac{1}{s \cdot C} I(s) = V_2(s)$$

Transfer function:

$$G(s) = \frac{V_2(s)}{V_1(s)} = \frac{R_2 \cdot C \cdot s + 1}{(R_1 + R_2)C \cdot s + 1}$$

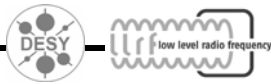

Input V_1 ,output V_2 7

CAS-DSP, Sigtuna 2007-Control Theory-S. Simrock

1.Introduction

Example 3: Circuit with operational amplifier

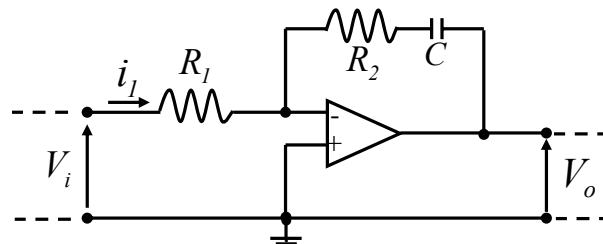

$$V_i(s) = R_i I_f(s) \quad \text{and} \quad V_o(s) = -\left(R_2 + \frac{1}{s \cdot C}\right) I_f(s)$$

$$G(s) = \frac{V_o(s)}{V_i(s)} = -\frac{R_2 \cdot C \cdot s + 1}{R_i \cdot C \cdot s}$$

It is convenient to derive a transfer function for a circuit with a single operational amplifier that contains input and feedback impedance:

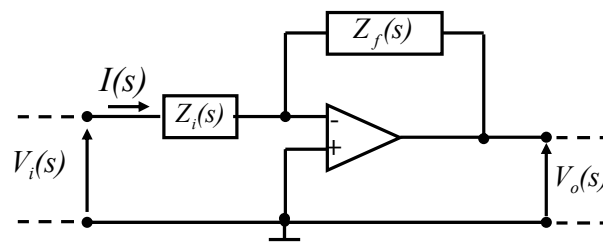

$$V_i(s) = Z_i(s) I(s) \quad \text{and} \quad V_o(s) = -Z_f(s) I(s) \quad \longrightarrow \quad G(s) = \frac{V_o(s)}{V_i(s)} = -\frac{Z_f(s)}{Z_i(s)}$$



CAS-DSP, Sigtuna 2007-Control Theory-S. Simrock

8

Model of Dynamic System

We will study the following dynamic system:

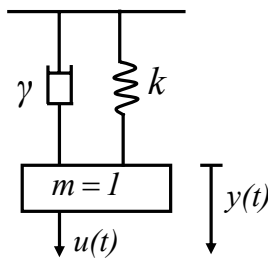

Parameters:

- k : spring constant
- γ : damping constant
- $u(t)$: force

Quantity of interest:

- $y(t)$: displacement from equilibrium

Differential equation: Newton's third law ($m = 1$)

$$\ddot{y}(t) = \sum F_{ext} = -k y(t) - \gamma \dot{y}(t) + u(t)$$

$$\ddot{y}(t) + \gamma \dot{y}(t) + k y(t) = u(t)$$

$$y(0) = y_0, \dot{y}(0) = \dot{y}_0$$

➤ Equation is linear (i.e. no \dot{y}^2 like terms).

➤ Ordinary (as opposed to partial e.g. $= \frac{\partial}{\partial x} \frac{\partial}{\partial t} f(x,t) = 0$)

➤ All coefficients constant: $k(t) = \kappa, \gamma(t) = \gamma$ for all t

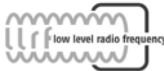

Model of Dynamic System

Stop calculating, let's paint!!!

Picture to visualize differential equation

1. Express highest order term (put it to one side)

$$\ddot{y}(t) = -k y(t) - \gamma \dot{y}(t) + u(t)$$

2. Put adder in front

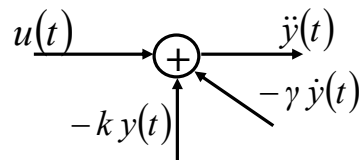

3. Synthesize all other terms using integrators!

Block diagram

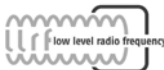
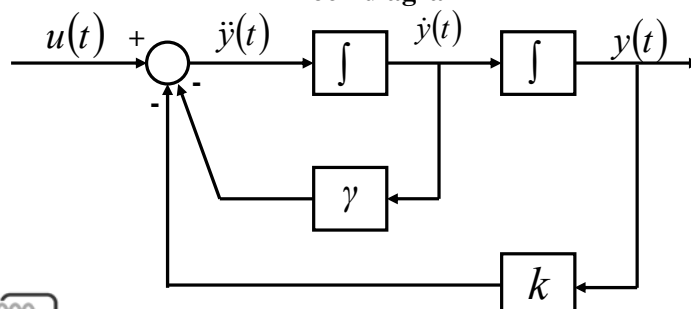

2.1 Linear Ordinary Differential Equation (LODE)

General form of LODE:

$$y^{(n)}(t) + a_{n-1}y^{(n-1)}(t) + \dots + a_1\dot{y}(t) + a_0y(t) = b_m u^{(m)}(t) + \dots + b_1\dot{u}(t) + b_0u(t)$$

m, n Positive integers, $m \leq n$; coefficients $a_0, a_1, \dots, a_{n-1}, b_0, \dots, b_m$ real numbers.

Mathematical solution: hopefully you know it

Solution of LODE: $y(t) = y_h(t) + y_p(t)$,

Sum of homogeneous solution $y_h(t)$ (natural response) solving

$$y^{(n)}(t) + a_{n-1}y^{(n-1)}(t) + \dots + a_1\dot{y}(t) + a_0y(t) = 0$$

And particular solution $y_p(t)$.

How to get natural response $y_h(t)$? Characteristic polynomial

$$\chi(\lambda) = \lambda^n + a_{n-1}\lambda^{n-1} + a_1\lambda + a_0 = 0$$

$$(\lambda - \lambda_1)^r \cdot (\lambda - \lambda_{r+1}) \cdot \dots \cdot (\lambda - \lambda_n) = 0$$

$$y_h(t) = (c_1 + c_2 t + \dots + c_r t^{r-1}) e^{\lambda_1 t} + c_{r+1} e^{\lambda_{r+1} t} + \dots + c_n e^{\lambda_n t}$$

Determination of $y_p(t)$ relatively simple, if input $u(t)$ yields only a finite number of independent derivatives. E.g.: $u(t) \cong e^{\zeta t}, \beta_r t^r$.



2.1 Linear Ordinary Differential Equation (LODE)

Most important for control system/feedback design:

$$y^{(n)}(t) + a_{n-1}y^{(n-1)}(t) + \dots + a_1\dot{y}(t) + a_0y(t) = b_m u^{(m)}(t) + \dots + b_1\dot{u}(t) + b_0u(t)$$

In general: given any linear time invariant system described by LODE can be realized/simulated/easily visualized in a block diagram ($n = 2, m = 2$)

Control-canonical form

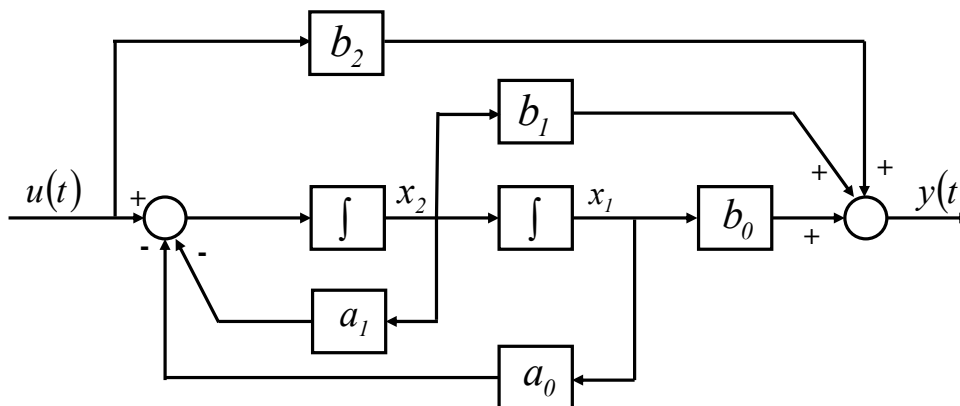

Very useful to visualize interaction between variables!

What are x_1 and x_2 ????

More explanation later, for now: please simply accept it!



2.2 State Space Equation

Any system which can be presented by LODE can be represented in *State space form* (matrix differential equation).

What do we have to do ???

Let's go back to our first example (Newton's law):

$$\ddot{y}(t) + \gamma \dot{y}(t) + k y(t) = u(t)$$

1. STEP: Deduce set off first order differential equation in variables

$x_j(t)$ (so-called states of system)

$x_1(t) \cong$ Position : $y(t)$

$x_2(t) \cong$ Velocity : $\dot{y}(t)$:

$$\dot{x}_1(t) = \dot{y}(t) = x_2(t)$$

$$\begin{aligned} \dot{x}_2(t) &= \ddot{y}(t) = -k y(t) - \gamma \dot{y}(t) + u(t) \\ &= -k x_1(t) - \gamma x_2(t) + u(t) \end{aligned}$$

One LODE of order n transformed into n LODEs of order 1

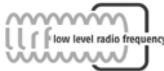

2.2 State Space Equation

2. STEP:

Put everything together in a matrix differential equation:

$$\begin{bmatrix} \dot{x}_1(t) \\ \dot{x}_2(t) \end{bmatrix} = \begin{bmatrix} 0 & I \\ -k & -\gamma \end{bmatrix} \begin{bmatrix} x_1(t) \\ x_2(t) \end{bmatrix} + \begin{bmatrix} 0 \\ I \end{bmatrix} u(t)$$

$$\dot{x}(t) = A x(t) + B u(t)$$

State equation

$$y(t) = \begin{bmatrix} I & 0 \end{bmatrix} \begin{bmatrix} x_1(t) \\ x_2(t) \end{bmatrix}$$

$$y(t) = C x(t) + D u(t)$$

Measurement equation

Definition:

The **system state** x of a system at any time t_0 is the "amount of information" that, together with all inputs for $t \geq t_0$, uniquely determines the behaviour of the system for all $t \geq t_0$.

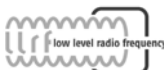

2.2 State Space Equation

The linear time-invariant (LTI) analog system is described via

Standard form of the State Space Equation

$$\dot{x}(t) = A x(t) + B u(t) \quad \text{State equation}$$

$$y(t) = C x(t) + D u(t) \quad \text{State equation}$$

Where $\dot{x}(t)$ is the time derivative of the vector $x(t) = \begin{bmatrix} x_1(t) \\ \vdots \\ x_n(t) \end{bmatrix}$. And starting conditions $x(t_0)$

System completely described by state space matrixes A, B, C, D (in the most cases $D=0$).

Declaration of variables

Variable	Dimension	Name
$X(t)$	$n \times 1$	state vector
A	$n \times n$	system matrix
B	$n \times r$	input matrix
$u(t)$	$r \times 1$	input vector
$y(t)$	$p \times 1$	output vector
C	$p \times n$	output matrix
D	$p \times r$	matrix representing direct coupling between input and output

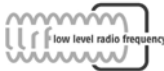

2.2 State Space Equation

Why all this work with state space equation? Why bother with?

BECAUSE: Given any system of the LODE form

$$y^{(n)}(t) + a_{n-1} y^{(n-1)}(t) + \dots + a_1 \dot{y}(t) + a_0 y(t) = b_m u^{(m)}(t) + \dots + b_1 \dot{u}(t) + b_0 u(t)$$

Can be represented as

$$\begin{aligned} \dot{x}(t) &= A x(t) + B u(t) \\ y(t) &= C x(t) + D u(t) \end{aligned}$$

with e.g. **Control-Canonical Form** (case $n = 3, m = 3$):

$$A = \begin{bmatrix} 0 & 1 & 0 \\ 0 & 0 & 1 \\ -a_0 & -a_1 & -a_2 \end{bmatrix}, B = \begin{bmatrix} 0 \\ 0 \\ 1 \end{bmatrix}, C = [b_0 \ b_1 \ b_2], D = b_3$$

or **Observer-Canonical Form**:

$$A = \begin{bmatrix} 0 & 0 & -a_0 \\ 1 & 0 & -a_1 \\ 0 & 1 & -a_2 \end{bmatrix}, B = \begin{bmatrix} b_0 \\ b_1 \\ b_2 \end{bmatrix}, C = [0 \ 0 \ 1], D = b_3$$

Notation is very compact, But: not unique!!!

Computers love state space equation! (Trust us!)

Modern control (1960-now) uses state space equation.

General (vector) block diagram for easy visualization.

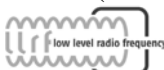

2.2 State Space Equation

Block diagrams:

Control-canonical Form:

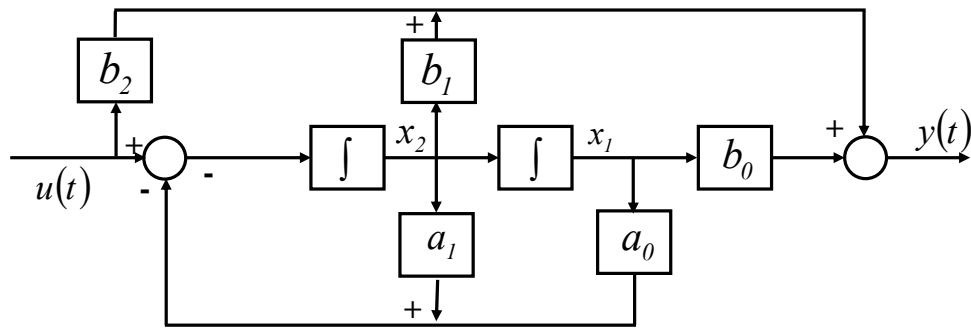

Observer-Canonical Form:

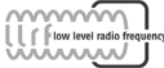
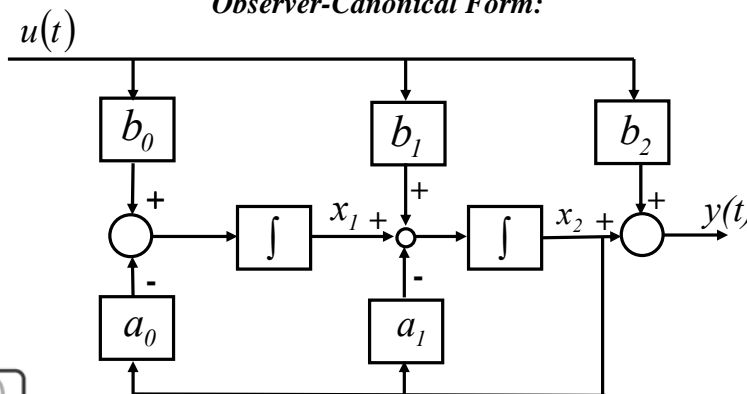

2.2 State Space Equation

Now: Solution of State Space Equation in the time domain. Out of the hat...et voila:

$$x(t) = \Phi(t) x(0) + \int_0^t \Phi(\tau) B u(t - \tau) d\tau$$

Natural Response + Particular Solution

$$\begin{aligned} y(t) &= C x(t) + D u(t) \\ &= C \Phi(t) x(0) + C \int_0^t \Phi(\tau) B u(t - \tau) d\tau + D u(t) \end{aligned}$$

With the state transition matrix

$$\Phi(t) = I + At + \frac{A^2}{2!} t^2 + \frac{A^3}{3!} t^3 + \dots = e^{At}$$

Exponential series in the matrix A (time evolution operator) properties of $\Phi(t)$ (state transition matrix).

1. $\frac{d\Phi(t)}{dt} = A \Phi(t)$
2. $\Phi(0) = I$
3. $\Phi(t_1 + t_2) = \Phi(t_1) \cdot \Phi(t_2)$
4. $\Phi^{-1}(t) = \Phi(-t)$

Example:

$$A = \begin{bmatrix} 0 & 1 \\ 0 & 0 \end{bmatrix} \Rightarrow A^2 = \begin{bmatrix} 0 & 0 \\ 0 & 0 \end{bmatrix}, \Phi(t) = I + At = \begin{bmatrix} 1 & t \\ 0 & 1 \end{bmatrix} = e^{At}$$

Matrix A is a nilpotent matrix.

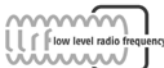

2.3 Examples

Example:

It is given the following differential equation:

$$\frac{d^2}{dt^2} y(t) + 4 \frac{d}{dt} y(t) + 3 y(t) = 2 u(t)$$

➤ State equations of differential equation:

Let $x_1(t) = y(t)$ and $x_2(t) = \dot{y}(t)$. It is:

$$\begin{aligned} \dot{x}_1(t) &= \dot{y}(t) = x_2(t) \\ \dot{x}_2(t) + 4 x_2(t) + 3 x_1(t) &= 2 u(t) \\ \dot{x}_2(t) &= -3 x_1(t) - 4 x_2(t) + 2 u(t) \end{aligned}$$

➤ Write the state equations in matrix form:

Define system state $x(t) = \begin{bmatrix} x_1(t) \\ x_2(t) \end{bmatrix}$. Then it follows:

$$\begin{aligned} \dot{x}(t) &= \begin{bmatrix} 0 & 1 \\ -3 & -4 \end{bmatrix} x(t) + \begin{bmatrix} 0 \\ 2 \end{bmatrix} u(t) \\ y(t) &= \begin{bmatrix} 1 & 0 \end{bmatrix} x(t) \end{aligned}$$



2.3 Cavity Model

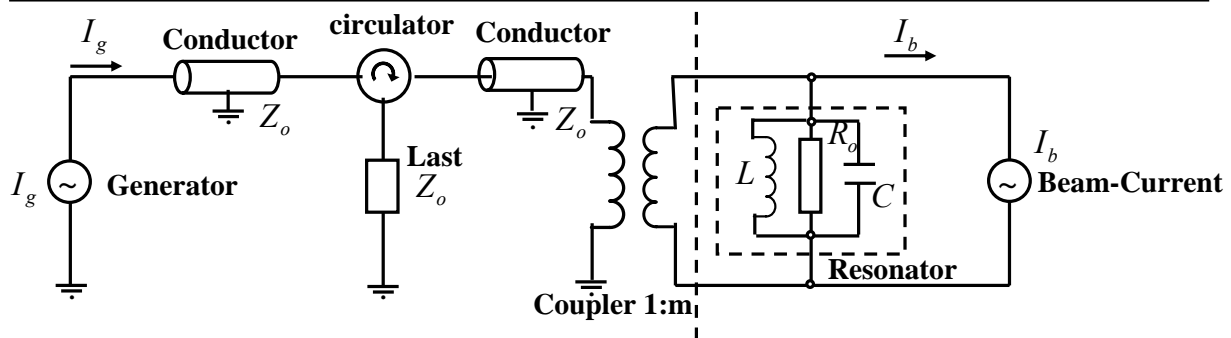

Equivalent circuit:

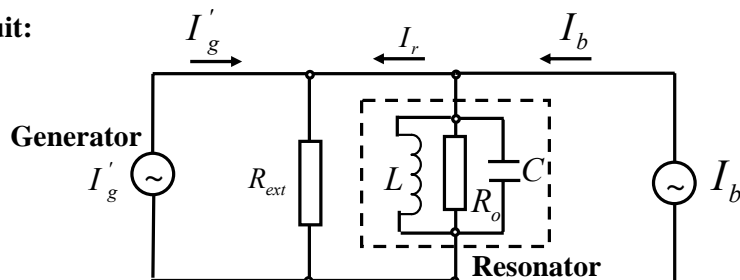

$$C \cdot \ddot{U} + \frac{1}{R_L} \cdot \dot{U} + \frac{1}{L} \cdot U = \dot{i}'_g + \dot{i}_b$$

$$\omega_{1/2} = \frac{1}{2R_L C} = \frac{\omega_0}{2Q_L}$$

$$\ddot{U} + 2\omega_{1/2} \cdot \dot{U} + \omega_0^2 \cdot U = 2R_L \omega_{1/2} \cdot \left(\frac{2}{m} \dot{i}'_g + \dot{i}_b \right)$$

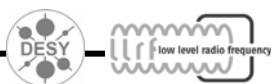

2.3 Cavity Model

Only envelope of $\mathbf{r}\mathbf{f}$ (real and imaginary part) is of interest:

$$\begin{aligned} U(t) &= (U_r(t) + i U_i(t)) \cdot \exp(i \omega_{HF} t) \\ I_g(t) &= (I_{gr}(t) + i I_{gi}(t)) \cdot \exp(i \omega_{HF} t) \\ I_b(t) &= (I_{b0r}(t) + i I_{b0i}(t)) \cdot \exp(i \omega_{HF} t) = 2(I_{b0r}(t) + i I_{b0i}(t)) \cdot \exp(i \omega_{HF} t) \end{aligned}$$

Neglect small terms in derivatives for U and I

$$\begin{aligned} \ddot{U}_r + i \ddot{U}_i &\ll \omega_{HF}^2 (U_r(t) + i U_i(t)) \\ 2\omega_{1/2} (\dot{U}_r + i \dot{U}_i) &\ll \omega_{HF}^2 (U_r(t) + i U_i(t)) \\ \int_{t_1}^{t_2} (\dot{I}_r(t) + i \dot{I}_i(t)) dt &\ll \int_{t_1}^{t_2} \omega_{HF} (I_r(t) + i I_i(t)) dt \end{aligned}$$

Envelope equations for real and imaginary component.

$$\begin{aligned} \dot{U}_r(t) + \omega_{1/2} \cdot U_r + \Delta\omega \cdot U_i &= \omega_{HF} \left(\frac{r}{Q}\right) \cdot \left(\frac{1}{m} I_{gr} + I_{b0r}\right) \\ \dot{U}_i(t) + \omega_{1/2} \cdot U_i - \Delta\omega \cdot U_r &= \omega_{HF} \left(\frac{r}{Q}\right) \cdot \left(\frac{1}{m} I_{gi} + I_{b0i}\right) \end{aligned}$$



2.3 Cavity Model

Matrix equations:

$$\begin{bmatrix} \dot{U}_r(t) \\ \dot{U}_i(t) \end{bmatrix} = \begin{bmatrix} -\omega_{1/2} & -\Delta\omega \\ \Delta\omega & -\omega_{1/2} \end{bmatrix} \cdot \begin{bmatrix} U_r(t) \\ U_i(t) \end{bmatrix} + \omega_{HF} \left(\frac{r}{Q}\right) \cdot \begin{bmatrix} 1 & 0 \\ 0 & 1 \end{bmatrix} \cdot \begin{bmatrix} \frac{1}{m} I_{gr}(t) + I_{b0r}(t) \\ \frac{1}{m} I_{gi}(t) + I_{b0i}(t) \end{bmatrix}$$

With system Matrices:

$$\begin{aligned} A &= \begin{bmatrix} -\omega_{1/2} & -\Delta\omega \\ \Delta\omega & -\omega_{1/2} \end{bmatrix} & B &= \omega_{HF} \left(\frac{r}{Q}\right) \cdot \begin{bmatrix} 1 & 0 \\ 0 & 1 \end{bmatrix} \\ \vec{x}(t) &= \begin{bmatrix} U_r(t) \\ U_i(t) \end{bmatrix} & \vec{u}(t) &= \begin{bmatrix} \frac{1}{m} I_{gr}(t) + I_{b0r}(t) \\ \frac{1}{m} I_{gi}(t) + I_{b0i}(t) \end{bmatrix} \end{aligned}$$

General Form:

$$\dot{\vec{x}}(t) = A \cdot \vec{x}(t) + B \cdot \vec{u}(t)$$

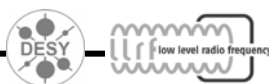

2.3 Cavity Model

Solution:

$$\vec{x}(t) = \Phi(t) \cdot \vec{x}(0) + \int_0^t \Phi(t-t') \cdot B \cdot \vec{u}(t') dt'$$

$$\Phi(t) = e^{-\omega_{1/2} t} \begin{bmatrix} \cos(\Delta\omega t) & -\sin(\Delta\omega t) \\ \sin(\Delta\omega t) & \cos(\Delta\omega t) \end{bmatrix}$$

Special Case:

$$\vec{u}(t) = \begin{bmatrix} \frac{1}{m} I_{gr}(t) + I_{b0r}(t) \\ \frac{1}{m} I_{gi}(t) + I_{b0i}(t) \end{bmatrix} =: \begin{bmatrix} I_r \\ I_i \end{bmatrix}$$

$$\begin{bmatrix} U_r(t) \\ U_i(t) \end{bmatrix} = \frac{\omega_{HF} \left(\frac{r}{Q} \right)}{\omega_{1/2}^2 + \Delta\omega^2} \cdot \begin{bmatrix} \omega_{1/2} & -\Delta\omega \\ \Delta\omega & \omega_{1/2} \end{bmatrix} \cdot \left\{ I - \begin{bmatrix} \cos(\Delta\omega t) & -\sin(\Delta\omega t) \\ \sin(\Delta\omega t) & \cos(\Delta\omega t) \end{bmatrix} e^{-\omega_{1/2} t} \right\} \cdot \begin{bmatrix} I_r \\ I_i \end{bmatrix}$$

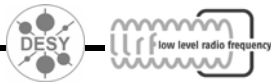

2.3 Cavity Model

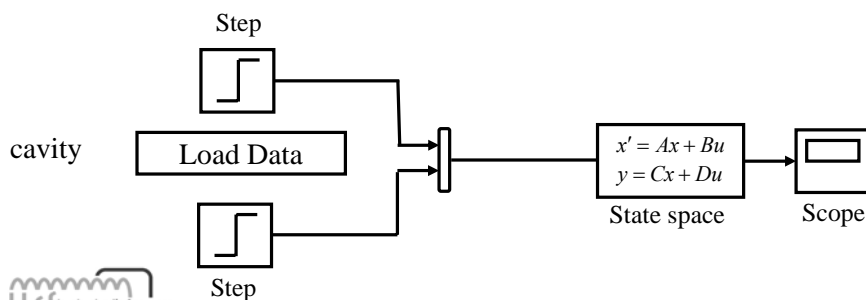
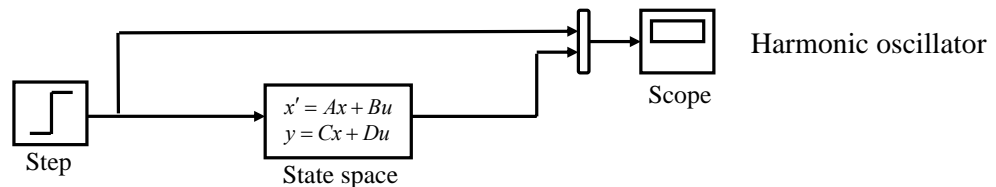
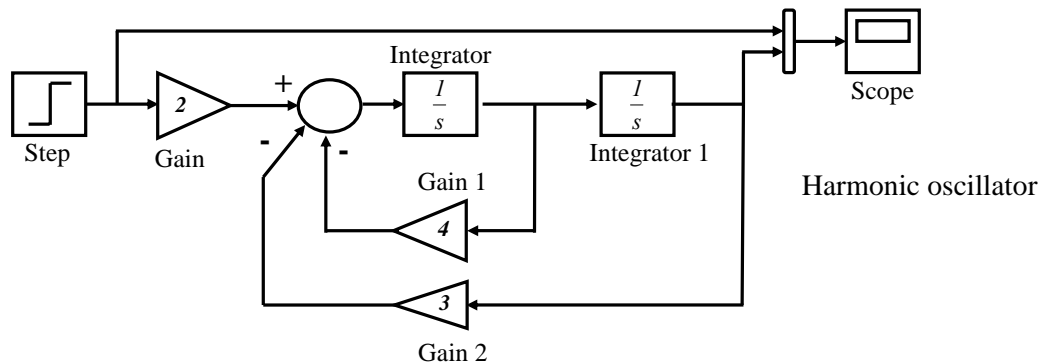

2.3 Cavity Model

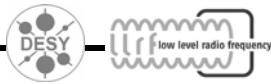
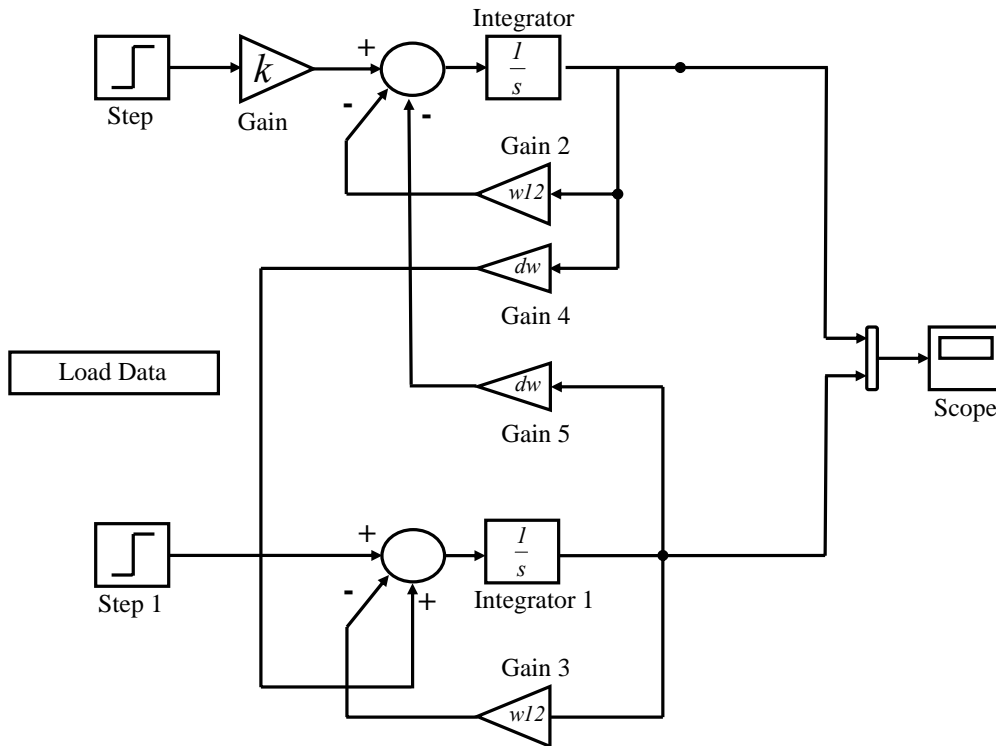

2.4 Masons Rule

Mason's Rule is a simple formula for reducing block diagrams. Works on continuous and discrete. In its most general form it is messy, but **For special case when all path touch**

$$H(s) = \frac{\sum(\text{forward path gains})}{1 - \sum(\text{loop path gains})}$$

Two path are said to touch if they have a component in common, e.g. an adder.

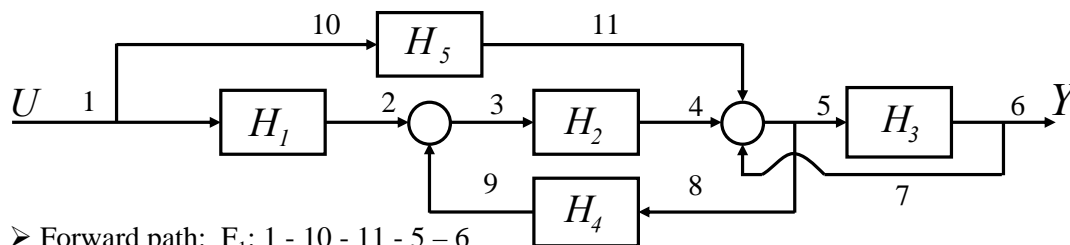

- Forward path: $F_1: 1 - 10 - 11 - 5 - 6$
 $F_2: 1 - 2 - 3 - 4 - 5 - 6$

- Loop path: $I_1: 3 - 4 - 5 - 8 - 9$
 $I_2: 5 - 6 - 7$

Check: all path touch (contain adder between 4 and 5)

$$G(f_1) = H_5 H_3$$

$$G(f_2) = H_1 H_2 H_3$$

$$G(I_1) = H_2 H_4$$

$$G(I_2) = H_3$$

➤ By Mason's rule:
$$H = \frac{G(f_1) + G(f_2)}{1 - G(I_1) - G(I_2)} = \frac{H_5 H_3 + H_1 H_2 H_3}{1 - H_2 H_4 - H_3} = \frac{H_3 (H_5 + H_1 H_2)}{1 - H_2 H_4 - H_3}$$



2.5 Transfer Function G (s)

Continuous-time state space model

$$\begin{aligned}\dot{x}(t) &= A x(t) + B u(t) && \text{State equation} \\ y(t) &= C x(t) + D u(t) && \text{Measurement equation}\end{aligned}$$

Transfer function describes input-output relation of system.



$$s X(s) - x(0) = A X(s) + B U(s)$$

$$\begin{aligned}X(s) &= (sI - A)^{-1} x(0) + (sI - A)^{-1} B U(s) \\ &= \varphi(s) x(0) + \varphi(s) B U(s)\end{aligned}$$

$$\begin{aligned}Y(s) &= C X(s) + D U(s) \\ &= C[(sI - A)^{-1} x(0) + (sI - A)^{-1} B U(s)] + D U(s) \\ &= C \varphi(s) x(0) + C \varphi(s) B U(s) + D U(s)\end{aligned}$$

Transfer function $G(s)$ (pxr) (case: $x(0)=0$):

$$G(s) = C(sI - A)^{-1} B + D = C \varphi(s) B + D$$



2.5 Transfer Function

Transfer function of TESLA cavity including 8/9-pi mode

$$H_{cont}(s) \approx H_{cav}(s) = H_{\pi}(s) + H_{\frac{8}{9}\pi}(s)$$

$$\pi - mode \quad H_{\pi}(s) = \frac{(\omega_{1/2})_{\pi}}{\Delta\omega_{\pi}^2 + (s + (\omega_{1/2})_{\pi})^2} \begin{pmatrix} s + (\omega_{1/2})_{\pi} & -\Delta\omega_{\pi} \\ -\Delta\omega_{\pi} & s + (\omega_{1/2})_{\pi} \end{pmatrix}$$

$$\frac{8}{9}\pi - mode \quad H_{\frac{8}{9}\pi}(s) = -\frac{(\omega_{1/2})_{\frac{8}{9}\pi}}{\Delta\omega_{\frac{8}{9}\pi}^2 + (s + (\omega_{1/2})_{\frac{8}{9}\pi})^2} \begin{pmatrix} s + (\omega_{1/2})_{\frac{8}{9}\pi} & -\Delta\omega_{\frac{8}{9}\pi} \\ \Delta\omega_{\frac{8}{9}\pi} & s + (\omega_{1/2})_{\frac{8}{9}\pi} \end{pmatrix}$$



2.5 Transfer Function of a Closed Loop System

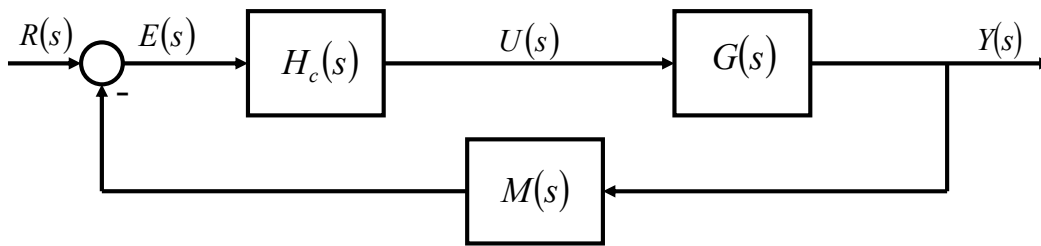

We can deduce for the output of the system.

$$\begin{aligned} Y(s) &= G(s) U(s) = G(s) H_c(s) E(s) \\ &= G(s) H_c(s) [R(s) - M(s) Y(s)] \\ &= L(s) R(s) - L(s) M(s) Y(s) \end{aligned}$$

With $L(s)$ the transfer function of the open loop system (controller plus plant).

$$\begin{aligned} (I + L(s) M(s)) Y(s) &= L(s) R(s) \\ Y(s) &= (I + L(s) M(s))^{-1} L(s) R(s) \\ &= T(s) R(s) \end{aligned}$$

$T(s)$ is called : Reference Transfer Function

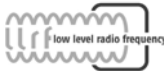

2.5 Sensitivity

The ratio of change in Transferfunction $T(s)$ by the parameter b can be defined as:

System characteristics change with system parameter variations

$$S = \frac{\Delta T(s)}{T(s)} \frac{b}{\Delta b}$$

The sensitivity function is defined as:

$$S_b^T = \lim_{\Delta b \rightarrow 0} \frac{\Delta T(s)}{\Delta b} \frac{b}{T(s)} = \frac{\partial T(s)}{\partial b} \frac{b}{T(s)}$$

Or in General sensitivity function of a characteristics W with respect to the parameter b :

$$S_b^W = \frac{\partial W}{\partial b} \frac{b}{W}$$

Example: plant with propotional feedback given by

$$G_c(s) = K_p \quad G_p(s) = \frac{K}{s + 0.1}$$

Plant transfer function $T(s)$:
$$T(s) = \frac{K_p G_p(s)}{1 + K_p G_p(s) H_k}$$

$$S_H^T(j\omega) = \frac{-K_p G_p(j\omega) H_k}{1 + K_p G_p(j\omega) H_k} = \frac{-0.25 K_p}{0.1 + 0.25 K_p + j\omega}$$

Increase of H results in decrease of T
 \rightarrow System can't be insensitive to both H, T

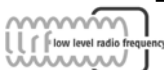
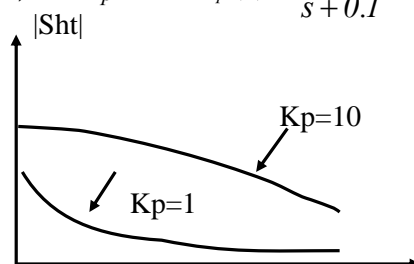

2.5 Disturbance Rejection

Disturbances are system influences we do not control and want to minimize its impact on the system.

$$C(s) = \frac{G_c(s) \cdot G_p(s)}{1 + G_c(s) \cdot G_p(s) \cdot H(s)} R(s) + \frac{G_d(s)}{1 + G_c(s) \cdot G_p(s) \cdot H(s)} D(s)$$

$$= T(s) \cdot R(s) + T_d(s) \cdot D(s)$$

To Reject disturbances, make $T \cdot d(s) \cdot D(s)$ small!

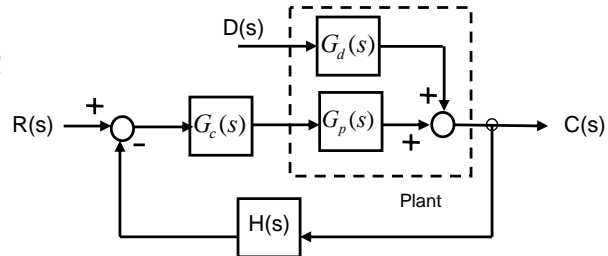

- Using frequency response approach to investigate disturbance rejection
- In general $T_d(j\omega)$ can't be small for all ω
- Design $T_d(j\omega)$ small for significant portion of system bandwidth
- Reduce the Gain $G_d(j\omega)$ between dist. Input and output
- Increase the loop gain $G_c G_p(j\omega)$ without increasing the gain $G_d(j\omega)$. Usually accomplished by the compensator choice $G_c(j\omega)$
- Reduce the disturbance magnitude $d(t)$ should always be attempted if reasonable
- Use feed forward compensation, if disturbance can be measured.

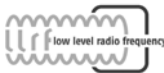

2.6 Stability

Now we have learnt so far:

The impulse response tells us everything about the system response to any arbitrary input signal $u(t)$.

what we have not learnt:

If we know the transfer function $G(s)$, how can we deduce the systems behavior? What can we say e.g. about the system stability?

Definition:

A linear time invariant system is called to be **BIBO** stable (Bounded-input-bounded-output) For all bounded inputs $|u(t)| \leq M_1$ (for all t) exists a boundary for the output signal M_2 , So that $|y(t)| \leq M_2$. (for all t) with M_1 and M_2 , positive real numbers.

Input never exceeds M_1 and output never exceeds M_2 , then we have BIBO stability!

Note: it has to be valid for ALL bounded input signals!

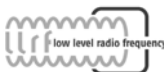

2.6 Stability

Example: $Y(s) = G(s) U(s)$, integrator $G(s) = \frac{1}{s}$

1. Case

$$u(t) = \delta(t), \quad U(s) = 1$$

$$|y(t)| = |L^{-1}[Y(s)]| = \left| L^{-1} \left[\frac{1}{s} \right] \right| = 1$$

The bounded input signal causes a bounded output signal.

2. Case

$$u(t) = 1, \quad U(s) = \frac{1}{s}$$

$$|y(t)| = |L^{-1}[Y(s)]| = \left| L^{-1} \left[\frac{1}{s^2} \right] \right| = t$$

BIBO-stability has to be shown/proved for any input. It is not sufficient to show its validity for a single input signal!

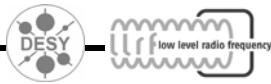

2.6 Stability

Condition for BIBO stability:

We start from the input-output relation

$$Y(s) = G(s) U(s)$$

By means of the convolution theorem we get

$$|y(t)| = \left| \int_0^t g(\tau) u(t-\tau) d\tau \right| \leq \int_0^t |g(\tau)| |u(t-\tau)| d\tau \leq M_1 \int_0^t |g(\tau)| d\tau \leq M_2$$

Therefore it follows immediately:

If the impulse response is absolutely integrable

$$\int_0^{\infty} |g(t)| dt < \infty$$

Then the system is BIBO-stable.



2.7 Poles and Zeroes

Can stability be determined if we know the TF of a system?

$$G(s) = C \Phi(s) B + D = C \frac{[sI - A]_{adj}}{\chi(s)} B + D$$

Coefficients of Transfer function $G(s)$ are rational functions in the complex variables

$$g_{ij}(s) = \alpha \cdot \frac{\prod_{k=1}^m (s - z_k)}{\prod_{l=1}^n (s - p_l)} = \frac{N_{ij}(s)}{D_{ij}(s)}$$

Z_k Zeroes. P_l Poles, α real constant, and it is $m \leq n$ (we assume common factors have already been canceled!)

What do we know about the zeros and the poles?

Since numerator $N(s)$ and denominator $D(s)$ are polynomials with real coefficients, Poles and zeroes must be real numbers or must arise as complex conjugated pairs!



2.7 Poles and Zeroes

Stability directly from state-space

$$\text{Recall : } H(s) = C(sI - A)^{-1} B + D$$

Assuming $D=0$ (D could change zeros but not poles)

$$H(s) = \frac{C \text{adj}(sI - A) B}{\det(sI - A)} = \frac{b(s)}{a(s)}$$

Assuming there are no common factors between the poly $C \text{adj}(sI - A) B$ and $\det(sI - A)$ i.e. no pole-zero cancellations (usually true, system called "minimal") then we can identify

$$\text{and} \quad b(s) = C \text{adj}(sI - A) B$$

$$a(s) = \det(sI - A)$$

i.e. poles are root of $\det(sI - A)$

Let λ_i be the i^{th} eigenvalue of A

if $\text{Re}\{\lambda_i\} \leq 0$ for all $i \Rightarrow$ System stable

So with computer, with eigenvalue solver, can determine system stability directly from coupling matrix A .

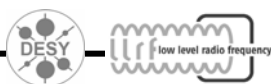

2.8 Stability Criteria

- A system is BIBO stable if, for every bounded input, the output remains bounded with increasing time.
- For a LTI system, this definition requires that all poles of the closed-loop transfer-function (all roots of the system characteristic equation) lie in the left half of the complex plane.

Several methods are available for stability analysis:

1. Routh Hurwitz criterion

2. Calculation of exact locations of roots

- a. Root locus technique
- b. Nyquist criterion
- c. Bode plot

3. Simulation (only general procedures for nonlinear systems)

- While the first criterion proves whether a feedback system is stable or unstable, the second Method also provides information about the setting time (damping term).

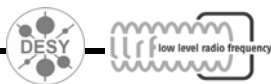

2.8 Poles and Zeroes

Pole locations tell us about impulse response i.e. also stability:

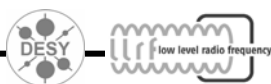
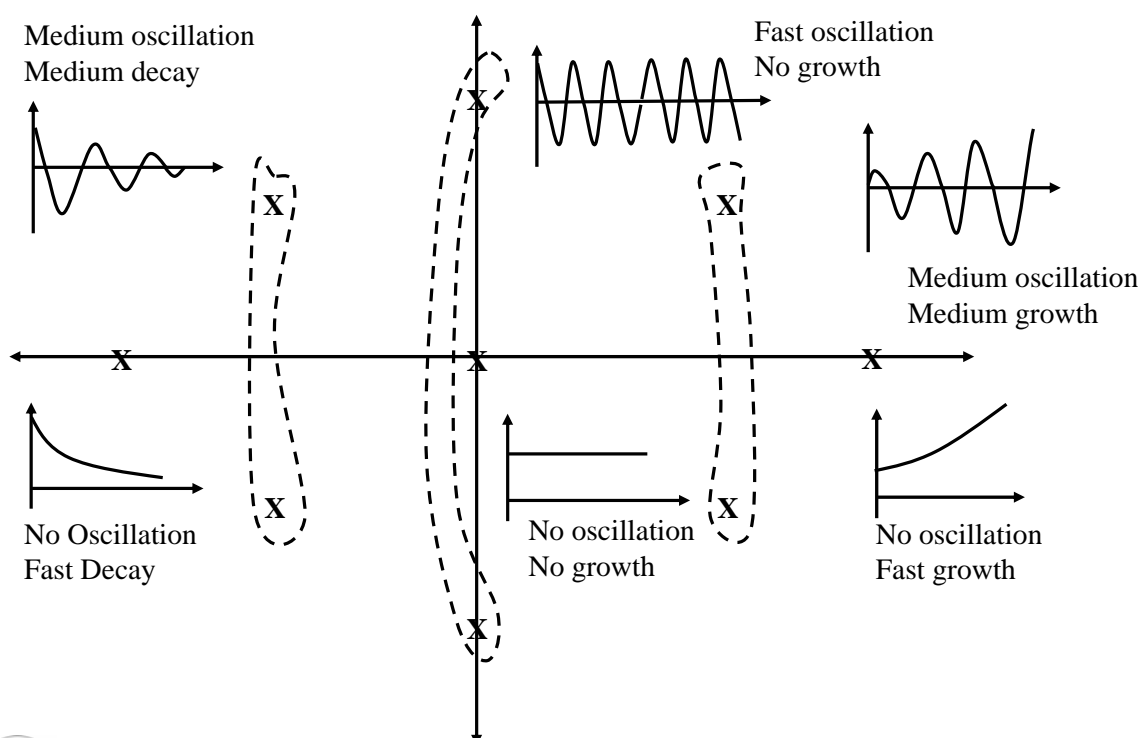

2.8 Poles and Zeroes

Furthermore: Keep in mind the following picture and facts!

➤ Complex pole pair: Oscillation with growth or decay.

➤ Real pole: exponential growth or decay.

➤ Poles are the Eigenvalues of the matrix A.

➤ Position of zeros goes into the size of C_j

✓ In general a complex root must have a corresponding conjugate root ($N(s)$, $D(S)$ polynomials with real coefficients.



2.8 Bode Diagram

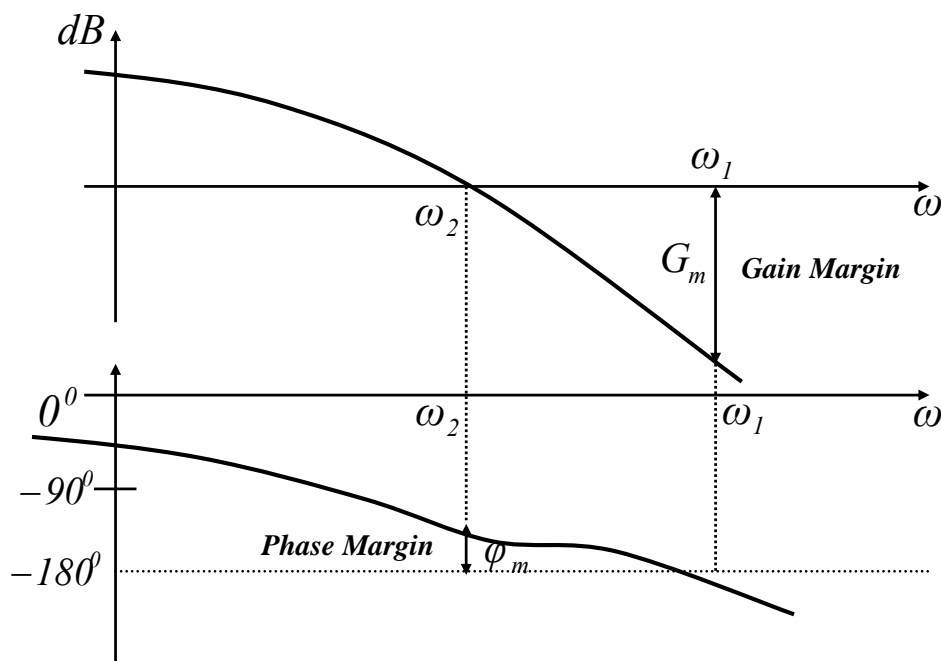

The closed loop is stable if the phase of the unity crossover frequency of the OPEN LOOP Is larger than -180 degrees.

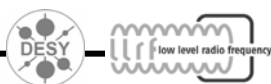

2.8 Nyquist Criterion

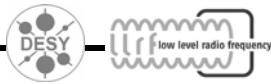
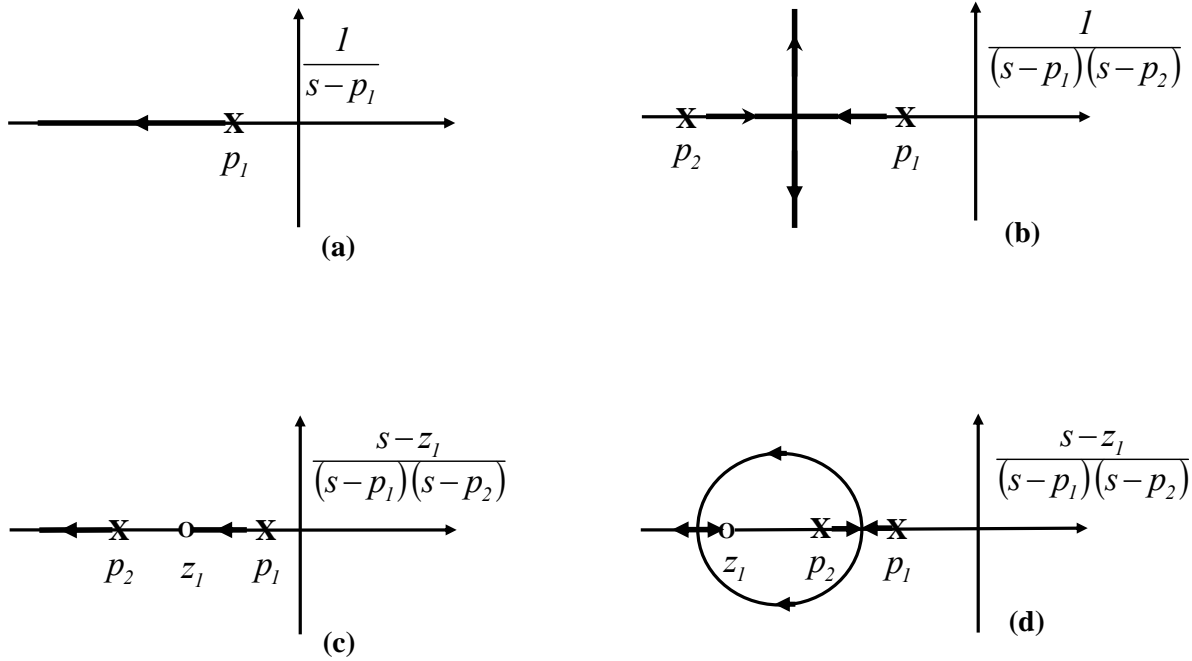

2.8 Nyquist Criterion (Cnt'd)

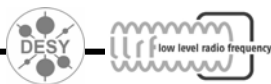
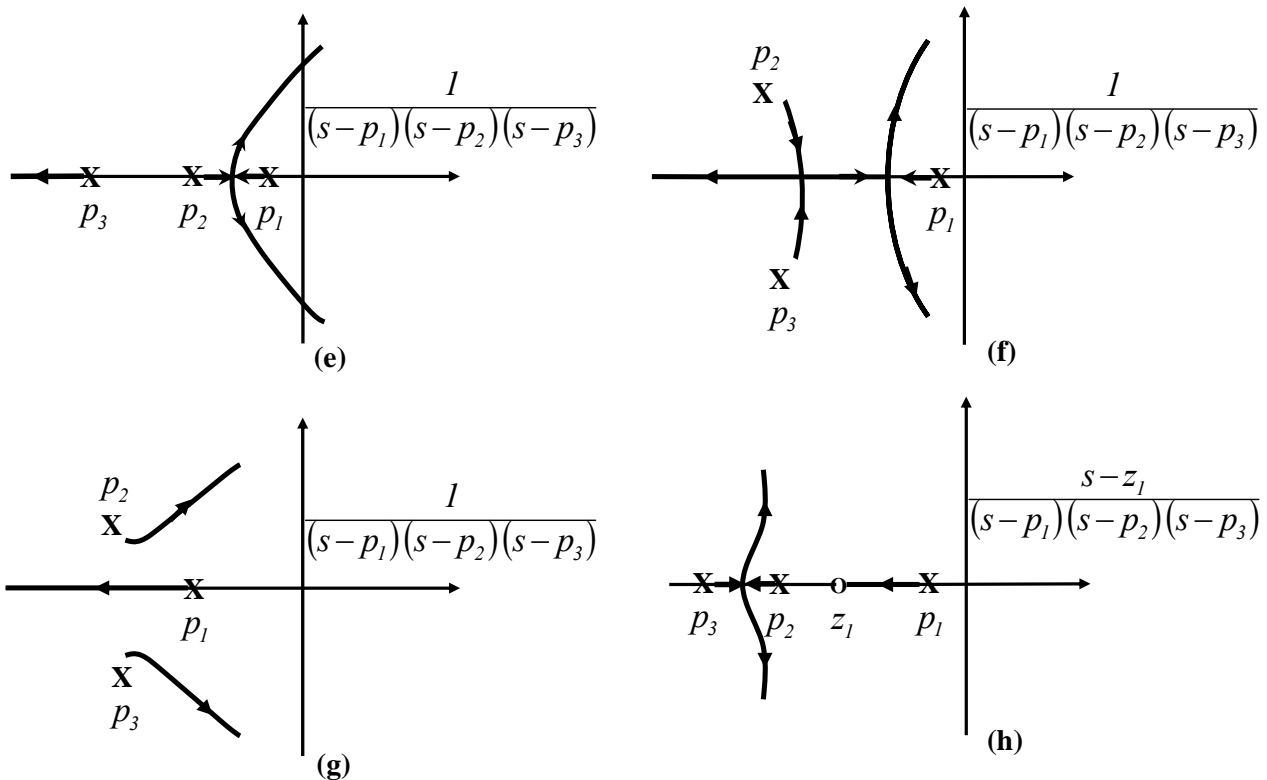

2.8 Root Locus Analysis

Definition: A root locus of a system is a plot of the roots of the system characteristic equation (the poles of the closed-loop transfer function) while some parameter of the system (usually the feedback gain) is varied.

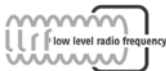
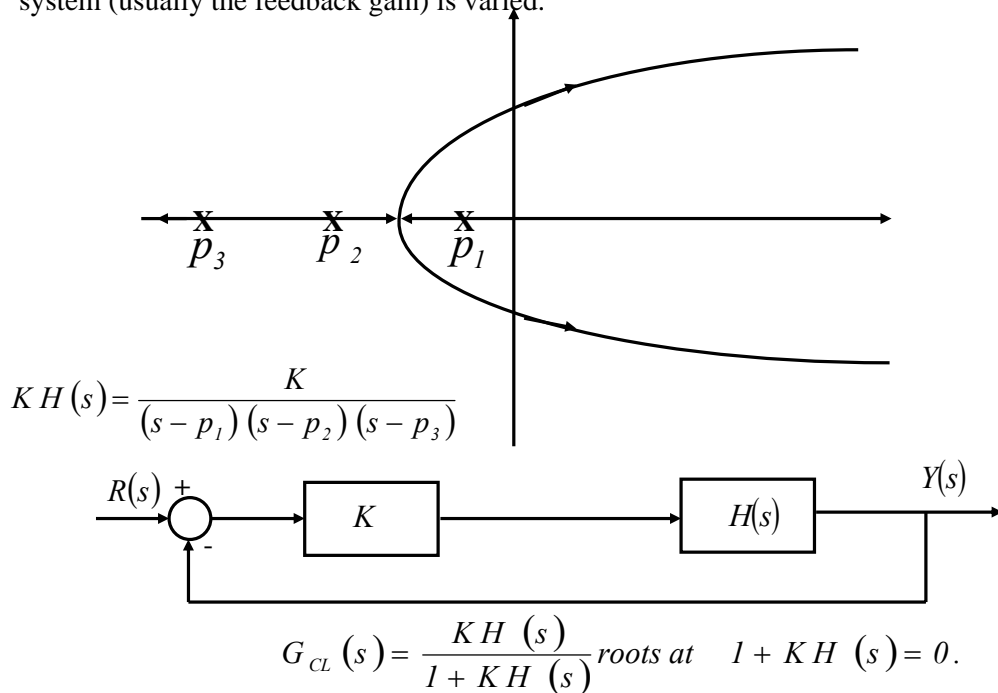

How do we move the poles by varying the constant gain K ?

3. Feedback

The idea:

Suppose we have a system or “plant”

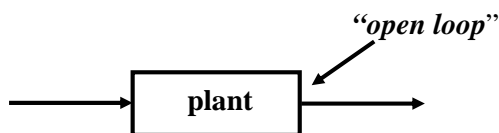

We want to improve some aspect of plant’s performance by observing the output and applying a appropriate “correction” signal. **This is feedback**

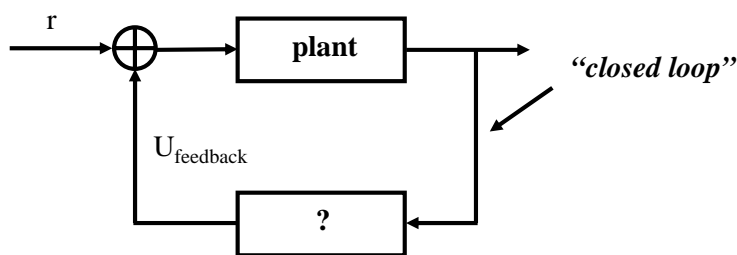

Question: What should this be?

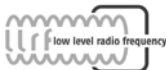

3.Feedback

Open loop gain:

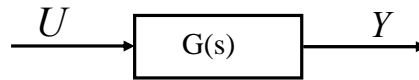

$$G^{o.L}(s) = G(s) = \left(\frac{u}{y}\right)^{-1}$$

Closed-loop gain:

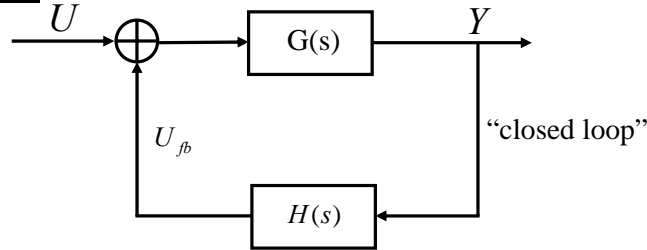

$$G^{c.L}(s) = \frac{G(s)}{1 + G(s)H(s)}$$

$$\begin{aligned} \text{Pr oof: } y &= G(u - u_{fb}) \\ &= G u - G u_{fb} & \Rightarrow y + G H_y &= G u \\ &= G u - G H y & \Rightarrow \frac{y}{u} &= \frac{G}{(1 + G H)} \end{aligned}$$



3.1 Feedback-Example 1

Consider S.H.O with feedback proportional to x i.e.:

Where

$$\begin{aligned} \ddot{x} + \gamma \dot{x} + \omega_n^2 x &= u + u_{fb} \\ u_{fb}(t) &= -\alpha x(t) \end{aligned}$$

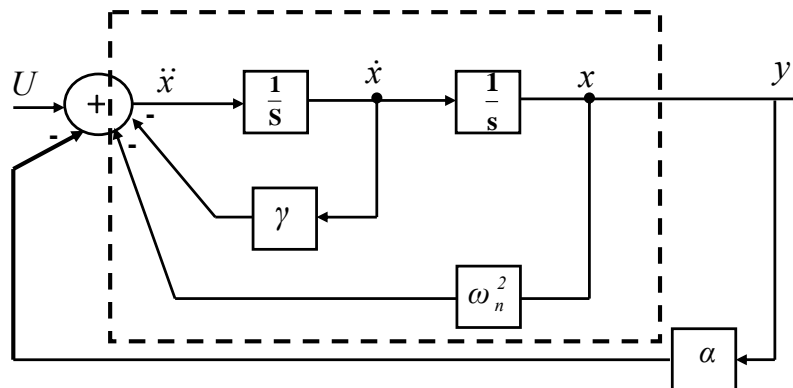

Then

$$\begin{aligned} \ddot{x} + \gamma \dot{x} + \omega_n^2 x &= u - \alpha x \\ \Rightarrow \ddot{x} + \gamma \dot{x} + (\omega_n^2 + \alpha) x &= u \end{aligned}$$



Same as before, except that new “natural” frequency $\omega_n^2 + \alpha$

3.1 Feedback-Example 1

Now the closed loop T.F. is: $G^{CL}(s) = \frac{1}{s^2 + \gamma s + (\omega_n^2 + \alpha)}$

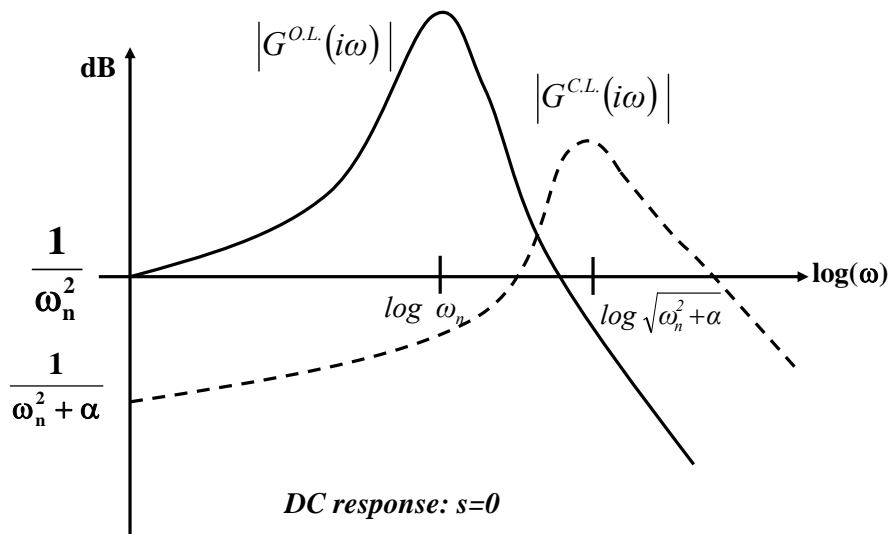

So the effect of the proportional feedback in this case is **to increase the bandwidth of the system**

(and reduce gain slightly, but this can easily be compensated by adding a constant gain in front...)

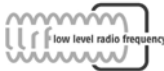

3.1 Feedback-Example 2

In S.H.O. suppose we use integral feedback:

$$u_{fb}(t) = -\alpha \int_0^t x(\tau) d\tau$$

$$i.e. \ddot{x} + \gamma \dot{x} + \omega_n^2 x = u - \alpha \int_0^t x(\tau) d\tau$$

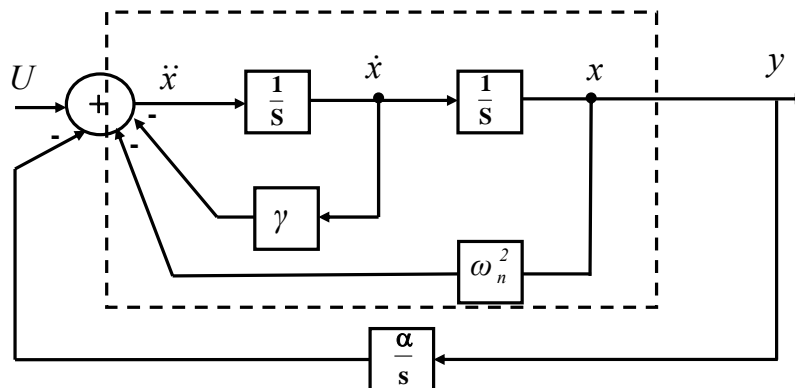

Differentiating once more yields: $\ddot{x} + \gamma \ddot{x} + \omega_n^2 \dot{x} + \alpha x = \dot{u}$

No longer just simple S.H.O., add another state

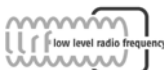

3.1 Feedback-Example 2

$$G^{CL}(s) = \frac{I}{s^2 + \gamma s + \omega_n^2} \cdot \frac{1}{1 + \left(\frac{\alpha}{s}\right) \left(\frac{I}{s^2 + \gamma s + (\omega_n^2 + \alpha)}\right)}$$

$$= \frac{s}{s(s^2 + \gamma s + \omega_n^2) + \alpha}$$

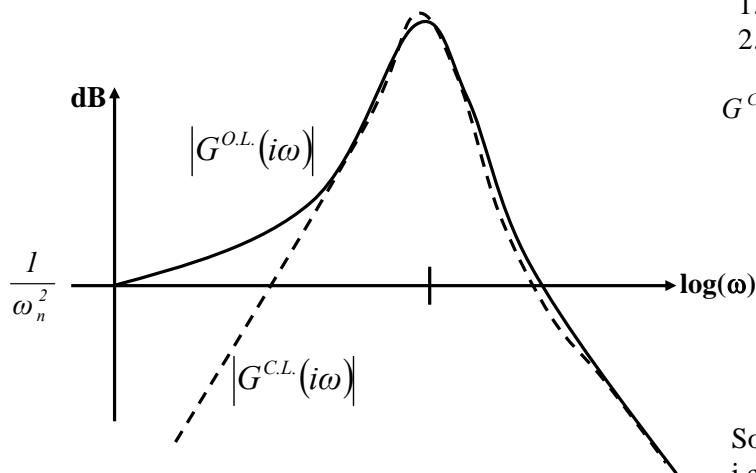

Observe that

1. $G^{CL}(0=0)$
2. For large s (and hence for large ω)

$$G^{CL}(s) \approx \frac{I}{(s^2 + \gamma s + \omega_n^2)} \approx G^{OL}(s)$$

So integral feedback has killed DC gain
i.e system rejects constant disturbances

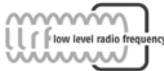

3.1 Feedback-Example 3

Suppose S.H.O now apply differential feedback i.e.

$$u_{fb}(t) = -\alpha \dot{x}(t)$$

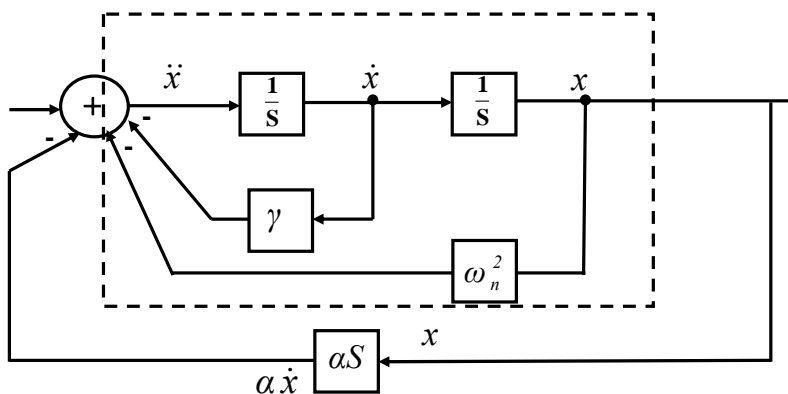

Now have

$$\ddot{x} + (\gamma + \alpha) \dot{x} + \omega_n^2 x = u$$

So effect off differential feedback is to increase damping

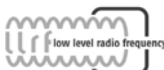

3.1 Feedback-Example 3

Now
$$G^{C.L.}(s) = \frac{I}{s^2 + (\gamma + \alpha)s + \omega_n^2}$$

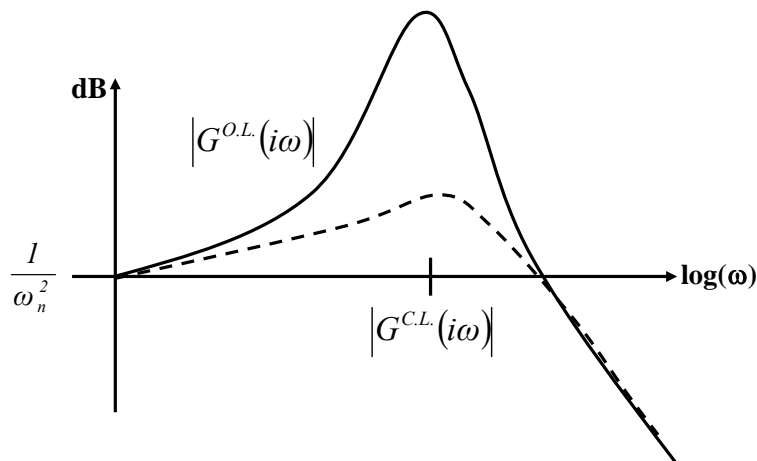

So the effect of differential feedback here is to “flatten the resonance” i.e. damping is increased.

Note: Differentiators can never be built exactly, only approximately.

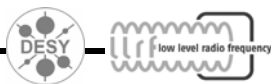

3.1 PID controller

- (1) The latter 3 examples of feedback can all be combined to form a P.I.D. controller (prop.-integral-diff).

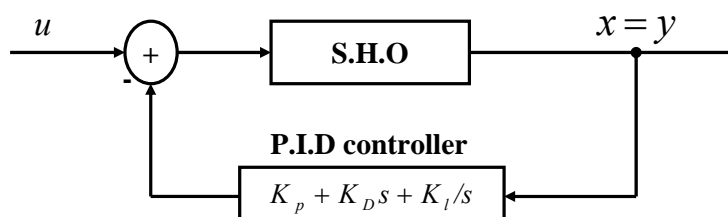

$$u_{fb} = u_p + u_d + u_i$$

- (2) In example above S.H.O. was a very simple system and it was clear what physical interpretation of P. or I. or D. did. But for large complex systems not obvious

→ Require arbitrary “tweaking”

That’s what we’re trying to avoid

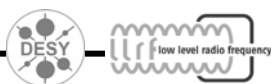

3.1 PID controller

For example, if you are so smart let's see you do this with your P.I.D. controller:

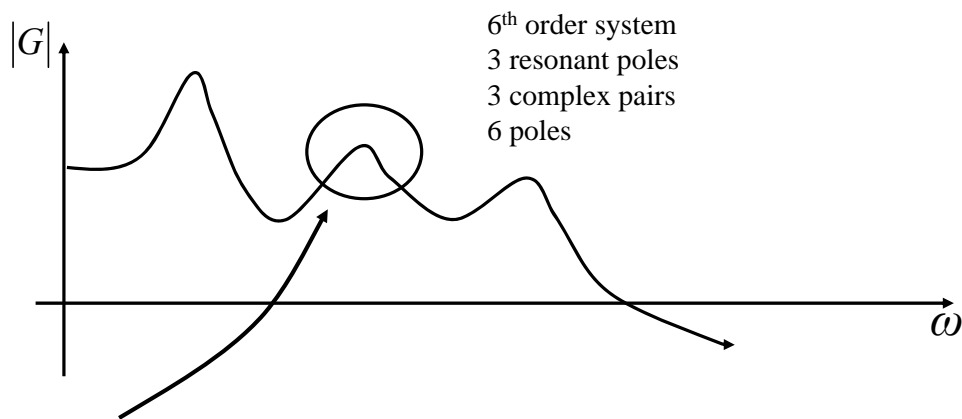

Damp this mode, but leave the other two modes undamped, just as they are.

This could turn out to be a tweaking nightmare that'll get you nowhere fast!

We'll see how this problem can be solved easily.

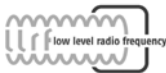

3.2 Full State Control

Suppose we have system

$$\begin{aligned}\dot{x}(t) &= A x(t) + B u(t) \\ y(t) &= C x(t)\end{aligned}$$

Since the state vector $x(t)$ contains all current information about the system the most general feedback makes use of all the state info.

$$\begin{aligned}u &= -k_1 x_1 - \dots - k_n x_n \\ &= -k x\end{aligned}$$

Where $k = [k_1, \dots, k_n]$ (row matrix)

Where example: In S.H.O. examples

$$\text{Proportional fbk : } u_p = -k_p x = -[k_p \ 0]$$

$$\text{Differential fbk : } u_D = -k_D \dot{x} = -[0 \ k_D]$$

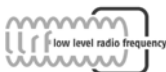

3.2 Full State Control

Theorem: If there are no poles cancellations in

$$G_{O.L.}(s) = \frac{b(s)}{a(s)} = C(sI - A)^{-1}B$$

Then can move eigen values of $A - BK$ anywhere we want using full state feedback.

Proof:

Given any system as L.O.D.E. or state space it can be written as:

$$\begin{aligned} \begin{bmatrix} \dot{x}_1 \\ \dots \\ \dot{x}_n \end{bmatrix} &= \overbrace{\begin{bmatrix} 0 & 1 & \dots & 0 \\ 0 & \dots & \dots & \dots \\ 0 & \dots & \dots & 1 \\ -a_0 & \dots & \dots & -a_{n-1} \end{bmatrix}}^{A^{O.L.}} \begin{bmatrix} x_1 \\ \dots \\ x_n \end{bmatrix} + \overbrace{\begin{bmatrix} 0 \\ 0 \\ \dots \\ 1 \end{bmatrix}}^B u \\ y &= \begin{bmatrix} b_0 & \dots & \dots & b_{n-1} \end{bmatrix} \begin{bmatrix} x_1 \\ \dots \\ x_n \end{bmatrix} \end{aligned}$$

Where

$$G^{O.L.} = C(sI - A)^{-1}B = \frac{b_{n-1}s^{n-1} + \dots + b_0}{s^n + a_{n-1}s^{n-1} + \dots + a_0}$$



3.2 Full State Control

i.e. first row of $A^{O.L.}$ Gives the coefficients of the denominator

$$a^{O.L.}(s) = \det(sI - A^{O.L.}) = s^n + a_{n-1}s^{n-1} + \dots + a_0$$

Now

$$A^{C.L.} = A^{O.L.} - BK$$

$$\begin{aligned} &= \begin{bmatrix} 0 & 1 & \dots & 0 \\ 0 & \dots & \dots & \dots \\ 0 & \dots & \dots & 1 \\ -a_0 & \dots & \dots & -a_{n-1} \end{bmatrix} - \begin{bmatrix} 0 \\ 0 \\ \dots \\ 1 \end{bmatrix} [k_0 \dots \dots k_{n-1}] \\ &= \begin{bmatrix} 0 & 1 & \dots & 0 \\ 0 & \dots & \dots & \dots \\ 0 & \dots & \dots & 1 \\ -(a_0 + k_0) & \dots & \dots & -(a_{n-1} + k_{n-1}) \end{bmatrix} \end{aligned}$$

So closed loop denominator

$$\begin{aligned} a^{C.L.}(s) &= \det(sI - A^{C.L.}) \\ &= s^n + (a_0 + k_0)s^{n-1} + \dots + (a_{n-1} + k_{n-1}) \end{aligned}$$

Using $u = -Kx$ have direct control over every closed-loop denominator coefficient

→ can place root anywhere we want in s-plane.



3.2 Full State Control

Example: Detailed block diagram of S.H.O with full-scale feedback

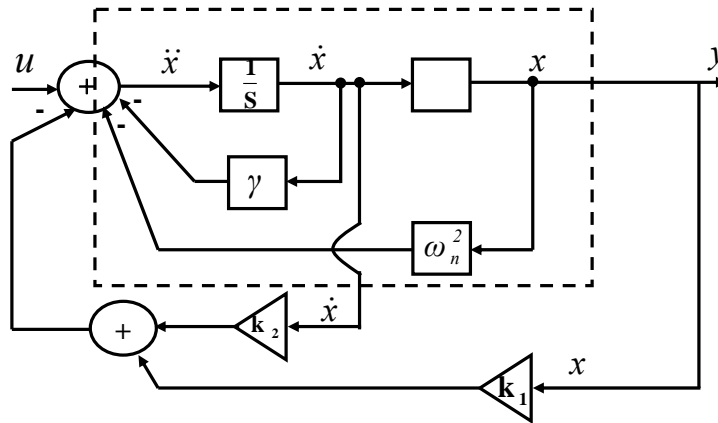

Of course this assumes we have access to the \dot{x} state, which we actually Don't in practice.

However, let's ignore that "minor" practical detail for now.
(Kalman filter will show us how to get \dot{x} from x).



3.2 Full State Control

With full state feedback have (assume $D=0$)

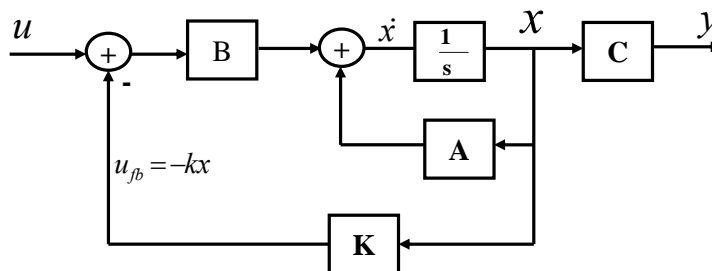

So

$$\begin{aligned}\dot{x} &= Ax + B[u + u_{fb}] \\ &= Ax + Bu + BKu_{fb} \\ \dot{x} &= (A - BK)x + Bu \\ u_{fb} &= -Kx \\ y &= Cx\end{aligned}$$

With full state feedback, get new closed loop matrix

$$A^{C.L.} = (A^{O.L.} - BK)$$

Now all stability info is now given by the eigen values of new A matrix

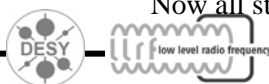

3.3 Controllability and Observability

The linear time-invariant system

$$\begin{aligned}\dot{x} &= Ax + Bu \\ y &= Cx\end{aligned}$$

Is said to be controllable if it is possible to find some input $u(t)$ that will transfer the initial state $x(0)$ to the origin of state-space, $x(t_0) = 0$, with t_0 finite

The solution of the state equation is:

$$x(t) = \varphi(t)x(0) + \int_0^t \varphi(t-\tau)Bu(\tau) d\tau$$

For the system to be controllable, a function $u(t)$ must exist that satisfies the equation:

$$0 = \varphi(t_0)x(0) + \int_0^{t_0} \varphi(t_0-\tau)Bu(\tau) d\tau$$

With t_0 finite. It can be shown that this condition is satisfied if the controllability matrix

$$C_M = [B \ AB \ A^2B \ \dots \ A^{n-1}B]$$

Has inverse. This is equivalent to the matrix C_M having full rank (rank n for an n -th order differential equation).

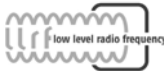

3.3 Controllability and Observability

Observable:

- The linear time-invariant system is said to be observable if the initial conditions $x(0)$ can be determined from the output function $y(t)$, $0 \leq t \leq t_1$, where t_1 is finite. With

$$y(t) = Cx = C\varphi(t)x(0) + C \int_0^t \varphi(t-\tau)Bu(\tau) d\tau$$

- The system is observable if this equation can be solved for $x(0)$. It can be shown that the system is observable if the matrix:

$$O_M = \begin{bmatrix} C \\ CA \\ \dots \\ CA^{n-1} \end{bmatrix}$$

- Has inverse. This is equivalent to the matrix O_M having full rank (rank n for an n -th order differential equation).

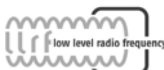

4. Discrete Systems

Where do discrete systems arise?

Typical control engineering example:

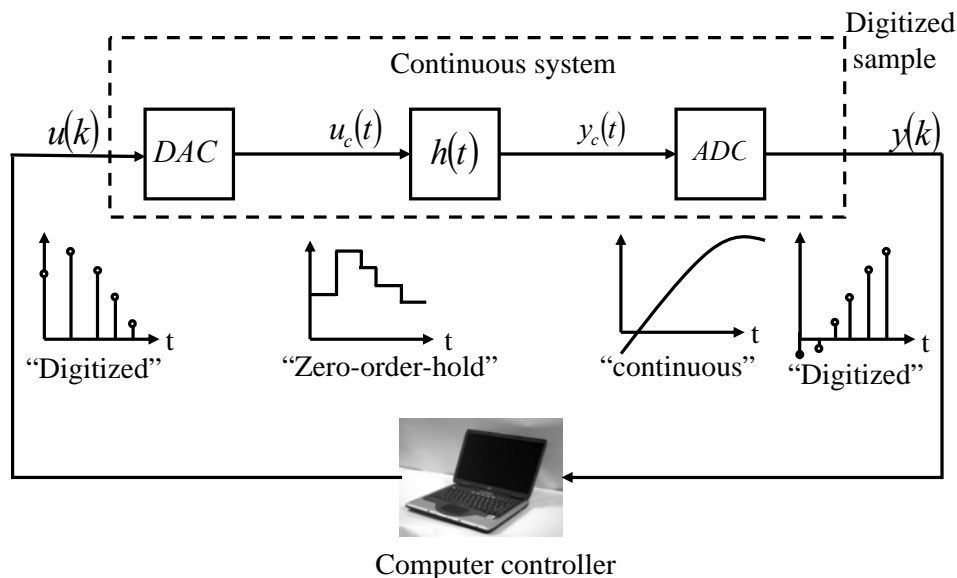

Assume the DAC+ADC are clocked at sampling period T .

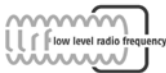

4. Discrete Systems

Then $u(t)$ is given by:

$$u(k) \equiv u_c(t); kT \leq t < (k+1)T$$

$$y(k) \equiv y_c(kT); k = 0, 1, 2, \dots$$

Suppose: time continuous system is given by state-Space

$$\dot{x}_c(t) = A x_c(t) + B u_c(t); x_c(0) = x_0$$

$$y_c(t) = C x_c(t) + D u_c(t)$$

Can we obtain direct relationship between $u(k)$ and $y(k)$? i.e. want

Equivalent discrete system:

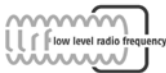
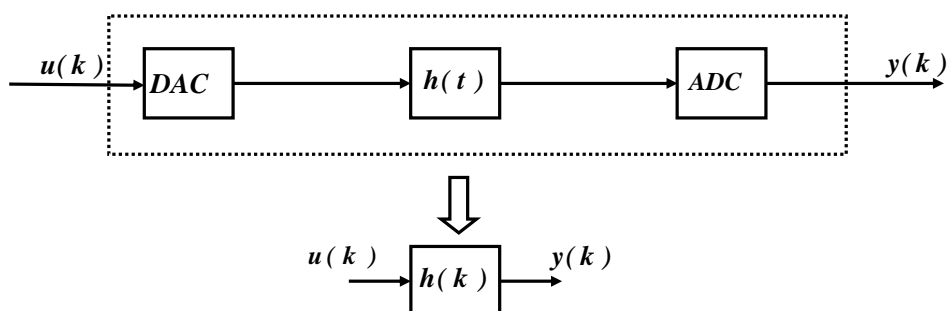

4. Discrete Systems

Yes! We can obtain equivalent discrete system.

Recall
$$x_c(t) = e^{At} x_c(0) + \int_0^t e^{A(t-\tau)} B u_c(t-\tau) d\tau$$

From this
$$x_c(kT + T) = e^{AT} x_c(kT) + \int_0^T e^{A(kT+\tau)} B u_c(kT + \tau) d\tau$$

Observe that $u(kT + T - \tau) = u(kT)$ for $\tau \in [0, T]$

i.e. $u(kT + T - \tau)$ is constant $u(kT)$ over $\tau \in [0, T]$

i.e. can pull out of integral.

$$\implies x_c(kT + T) = e^{AT} x_c(kT) + \left(\int_0^T e^{A\tau} \cdot B d\tau \right) u_c(kT)$$

$$x(k+1) = A_d x(k) + B_d u(k)$$

$$y(k) = C_d x(k) + D_d u(k)$$

$$x(0) = x_c(0)$$

$$\text{So } A_d = e^{AT}, B_d = \int_0^T e^{A\tau} B d\tau, C_d = C, D_d = D$$

So we have an exact (note: $x(k+1) = x(k) + \dot{x}(k) T + O(\cdot)$) discrete time equivalent to the time Continuous system at sample times $t=kT$ - no numerical approximation!

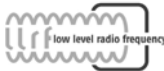

4.1 Linear Ordinary Difference Equation

A linear ordinary difference equation looks similar to a LODE

$$y(k+n) + a_{n-1} y(k+n-1) + \dots + a_1 y(k+1) + a_0 y(k) = b_m u(k+m) + \dots + b_1 u(k+1) + b_0 u(k)$$

$n \geq m$; Assumes initial values $y(n-1), \dots, y(1), y(0) = 0$.

Z-Transform of the LODE yields (linearity of Z-Transform):

$$z^n Y(z) + z^{n-1} a_{n-1} Y(z) + \dots + z a_1 Y(z) + a_0 Y(z) = z^m b_m U(z) + \dots + z b_1 U(z) + b_0 U(z)$$

It follows the input-output relation:

$$(z^n + z^{n-1} a_{n-1} + \dots + z a_1 + a_0) Y(z) = (z^m b_m + \dots + z b_1 + b_0) U(z)$$

$$Y(z) = \frac{z^m b_m + \dots + z b_1 + b_0}{z^n + \dots + z a_1 + a_0} U(z)$$

$$Y(z) = G(z) U(z)$$

Once again:

$$\text{if } U(z) = 1, (u(k) = \delta(k)), \text{ then } Y(z) = G(z).$$

Transfer Function of system is the Z-Transform of its pulse response!

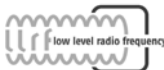

4.1 z-Transform of Discrete State Space Equation

$$\begin{aligned}x(k+1) &= A_d x(k) + B_d u(k) \\ y(k) &= C x(k) + D u(k)\end{aligned}$$

Applying z-Transform on first equation:

$$\begin{aligned}z \cdot X(z) - z x(0) &= A_d X(z) + B_d U(z) \\ (zI - A_d) X(z) &= z x(0) + B U(z)\end{aligned}$$

$$X(z) = (zI - A_d)^{-1} z x(0) + (zI - A_d)^{-1} B U(z)$$

Homogeneous solution

NOW: Particular solution

$$\begin{aligned}Y(z) &= C X(z) + D U(z) \\ &= C (zI - A_d)^{-1} z x(0) + (C(zI - A_d)^{-1} B + D) U(z)\end{aligned}$$

If $x(0)=0$ then we get the input-output relation:

$$\begin{aligned}Y(z) &= G(z) U(z) \text{ with} \\ G(z) &= C (zI - A_d)^{-1} B + D\end{aligned}$$

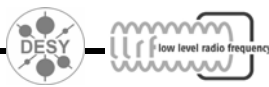

Exactly like for the continuous systems!!!!!!

65

CAS-DSP, Sigtuna 2007-Control Theory-S. Simrock

4.2 Frequency Domain/z-Transform

For analyzing discrete-time systems:

z-Transform

(analogue to Laplace Transform for time-continuous system)

It converts linear ordinary difference equation into algebraic equations: easier to find a solution of the system!

It gives the frequency response for free!

z-Transform == generalized discrete-time Fourier Transform

Given any sequence $f(k)$ the discrete Fourier transform is

$$\tilde{F}(\omega) = \sum_{k=-\infty}^{\infty} f(k) e^{-i\omega k}$$

with $\omega = 2\pi f$, $f = \frac{1}{T}$ the sampling frequency in Hz,

T difference / Time between two samples.

In the same spirit: $F(z) = Z[f(k)] = \sum_{k=0}^{\infty} f(k) z^{-k}$.

With z a complex variable

Note: if $f(k) = 0$ for $k = -1, -2, \dots$ then $\tilde{F}(\omega) = F(z = e^{i\omega})$.

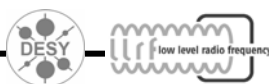

66

CAS-DSP, Sigtuna 2007-Control Theory-S. Simrock

4.3 Stability (z-domain)

A discrete LTI system is BIBO stable if

$$|u(k)| < M; \forall k = |y(k)| < K; \forall k$$

Condition for BIBO stability:

$$|y(k)| = \left| \sum_0^k u(k-i) h(i) \right| \leq \sum_0^k |u(k-i)| |h(i)| \leq M \sum_0^k |h(i)| \leq M \sum_0^{\infty} |h(i)|$$

$$\therefore \sum_0^{\infty} |h(i)| < \infty \rightarrow \text{BIBO stable.}$$

For L.O.D.E State space system:

$$H(z) = \alpha \cdot \frac{\prod_{i=1}^k (z - z_i)}{\prod_{i=1}^n (z - p_i)} = \sum_{i=1}^k \beta_i T_i(z)$$

With partial fraction of the rational function:

Once again pole locations tell a lot about shape of pulse response.

Zeros determine the size of β_i

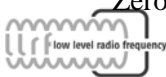

4.3 Stability (z- domain)

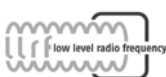
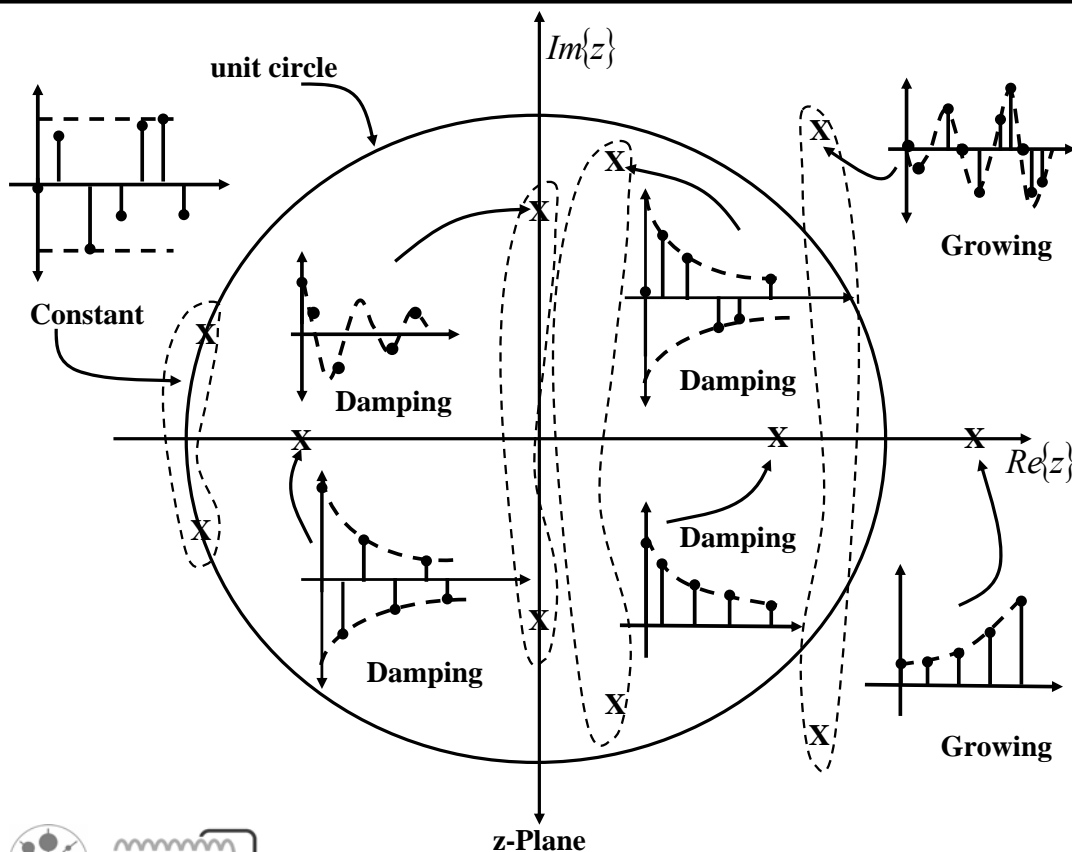

4.3 stability (Z- domain)

In General

Complex pair → oscillatory growth / damping

Real pole → exponential growth / decay but maybe oscillatory too (e.g: $r^n 1(n)$ where $r < 0$)

The farther inside unit circle poles are

→ The faster the damping → the higher stability

i.e $|p_i| \leq 1$ → **system stable**

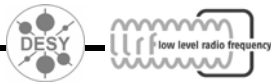

4.3 stability (z-domain)

Stability directly from State Space:

Exactly as for cts systems, assuming no pole-zero cancellations and $D=0$

$$\begin{aligned} H(z) &= \frac{b(z)}{a(z)} = C(zI - A_d)^{-1} B_d \\ &= \frac{C \text{adj}(zI - A_d) B_d}{\det(zI - A_d)} \end{aligned}$$

$$\begin{aligned} b(z) &= C \text{adj}(zI - A_d) B_d \\ a(z) &= \det(zI - A_d) \end{aligned}$$

→ Poles are eigenvalues of A_d

So check stability, use eigenvalue solver to get e-values of the matrix A_d , then

If $|\lambda_i| < 1$ for all i → system stable

Where λ_i is the i th e-value of A_d .

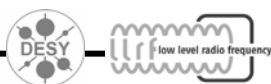

4.4 Discrete Cavity Model

Converting the transfer function from the continuous cavity model to the discrete model:

$$H(s) = \frac{\omega_{12}}{\Delta\omega^2 + (s + \omega_{12})^2} \begin{bmatrix} s + \omega_{12} & -\Delta \\ \Delta\omega & s + \omega_{12} \end{bmatrix}$$

The discretization of the model is represented by the z-transform:

$$H(z) = \left(1 - \frac{1}{z}\right) Z\left(\frac{H(s)}{s}\right) = \frac{z-1}{z} \cdot Z\left\{L^{-1}\left\{\frac{H(s)}{s}\right\}\right\}_{t=kT_s}$$

$$H(z) = \frac{\omega_{12}}{\Delta\omega^2 + \omega_{12}^2} \cdot \begin{bmatrix} \omega_{12} & -\Delta\omega \\ \Delta\omega & \omega_{12} \end{bmatrix} \cdot \left(\frac{\omega_{12}}{\Delta\omega^2 + \omega_{12}^2} \cdot \frac{z-1}{z^2 - 2ze^{\omega_{12}T_s} \cdot \cos(\Delta\omega T_s) + e^{2\omega_{12}T_s}} \right) \cdot \left\{ \left((z - e^{\omega_{12}T_s} \cdot \cos(\Delta\omega T_s)) \cdot \begin{bmatrix} \omega_{12} & -\Delta \\ \Delta\omega & \omega_{12} \end{bmatrix} \right) \cdot e^{\omega_{12}T_s} \cdot \sin(\Delta\omega T_s) \cdot \begin{bmatrix} \Delta\omega & \omega_{12} \\ -\omega_{12} & \Delta \end{bmatrix} \right\}$$

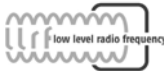

4.5 Linear Quadratic Regulator

Given:
$$\begin{aligned} x(k+1) &= Ax(k) + Bu(k) \\ z(k) &= Cx(k) \end{aligned}$$

(Assume D=0 for simplicity)

Suppose the system is unstable or almost unstable. We want to find $u_{fb}(k)$ which will bring $x(k)$ to Zero, quickly, from any Initial condition.

i.e.

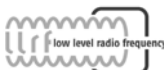
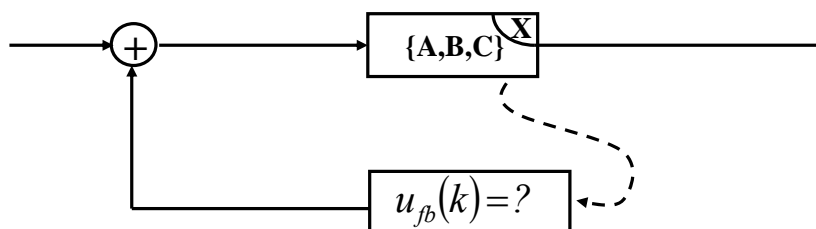

4.5 Trade Off

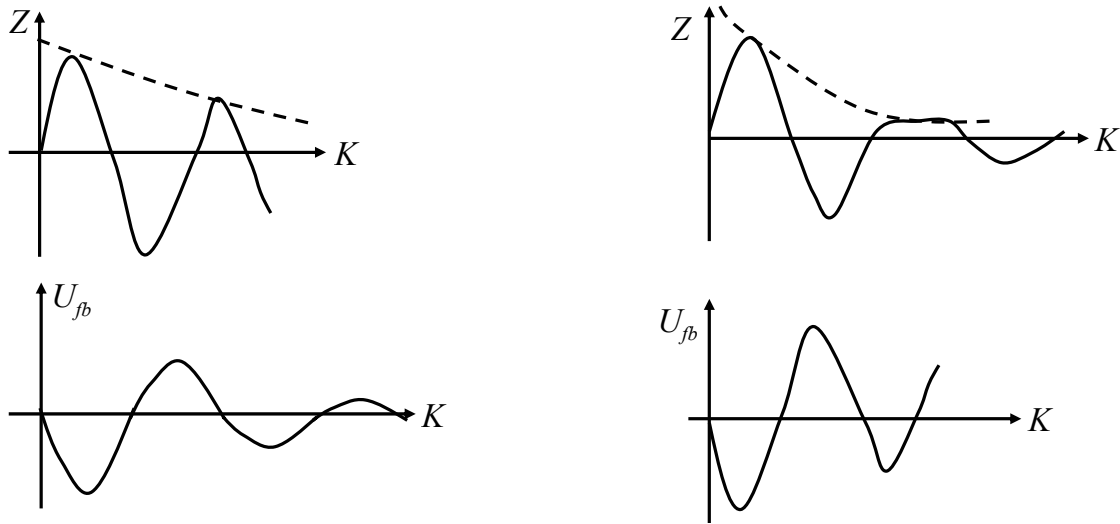

(1) "Bad" damping
 → **Large** Output excursions

(1) "Good" damping
 → **Small** Output excursions

(2) But "Cheap" control i.e. u_{fb} **Small**

(2) But "expensive control i.e. u_{fb} **large.**



4.5 Quadratic Forms

A quadratic form is a quadratic function of the components of a vector:

$$x = \begin{bmatrix} x_1 \\ x_2 \end{bmatrix} \in R^2$$

$$\begin{aligned} f(x) &= f(x_1, x_2) \\ &= ax_1^2 + bx_1x_2 + cx_1 + dx_2^2 \\ &= [x_1 \ x_2] \underbrace{\begin{bmatrix} a & \frac{1}{2}b \\ \frac{1}{2}b & d \end{bmatrix}}_Q \begin{bmatrix} x_1 \\ x_2 \end{bmatrix} + \underbrace{[c \ 0]}_{P^T} \begin{bmatrix} x_1 \\ x_2 \end{bmatrix} \end{aligned}$$

$$f(x) = \underbrace{x^T Q x}_{\text{Quadratic Part}} + \underbrace{P^T x}_{\text{Linear Part}} + \underbrace{e}_{\text{Constant}}$$

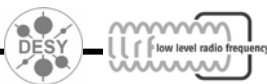

4.5 Quadratic Cost for Regulator

What do we mean by “bad“ damping and “cheap“ control? We now define precisely what we mean. Consider:

$$J \equiv \sum_{i=0}^{\infty} \{x_i^T Q x_i + u_i^T R u_i\}$$

The first term penalizes large state excursions, the second penalizes large control.

$$Q \geq 0, R > 0$$

Can tradeoff between state excursions and control by varying Q and R.

Large Q → “good“ damping important

Large R → actuator effort “expensive“



4.5 LQR Problem Statement

(Linear quadratic regulator)

Given: $x_{i+1} = Ax_i + Bu_i$; x_0 given:

Find control sequence $\{u_0, u_1, u_2, \dots\}$ such that

$$J = \sum_{i=0}^{\infty} x_i^T \{Q x_i + u_i^T R u_i\}$$

Answer: = minimum

The optimal control sequence is a state feedback sequence $\{u_i\}_0^{\infty}$

$$\begin{aligned} u_i &= -K_{opt} x_i \\ K_{opt} &= (R + B^T S B)^{-1} B^T S A \\ S &= A^T S A + Q - A^T A B (R + B^T S B)^{-1} B^T S A \end{aligned}$$

Algebraic Riccati Equation (A.R.E) for discrete-time systems.

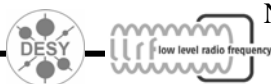

Note: Since u_i = state feedback, it works for any initial state x_0

4.5 LQR Problem Statement

Remarks:

- (1) So optimal control, $u_i = -K_{opt} x_i$ is state feedback! This is why we are interested in state feedback.
- (2) Equation A.R.E. is matrix quadratic equation. Looks pretty intimidating but Computer can solve in a second.
- (3) No tweaking ! Just specify {A,B,C,D} and Q and R, press return button, LQR Routine Spits out K_{opt} - done

(Of course picking Q and R is tricky sometimes but that's another story).

- (4) Design is guaranteed optimal in the sense that it minimizes.

$$J_{lqr}(x_0, \{u_i\}_0^\infty) = \sum_{i=0}^{\infty} \{x_i^T Q x_i + u_i^T R u_i\}$$

(Of course that doesn't mean its "best" in the absolute sense .-)

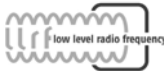

4.5 LQR Problem Statement - Remarks

- (5) As vary Q/R Ratio we get whole family of K_{lqr} 's, i.e. can Trade-off between state excursion (Damping) Vs actuator effort (Control)

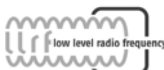
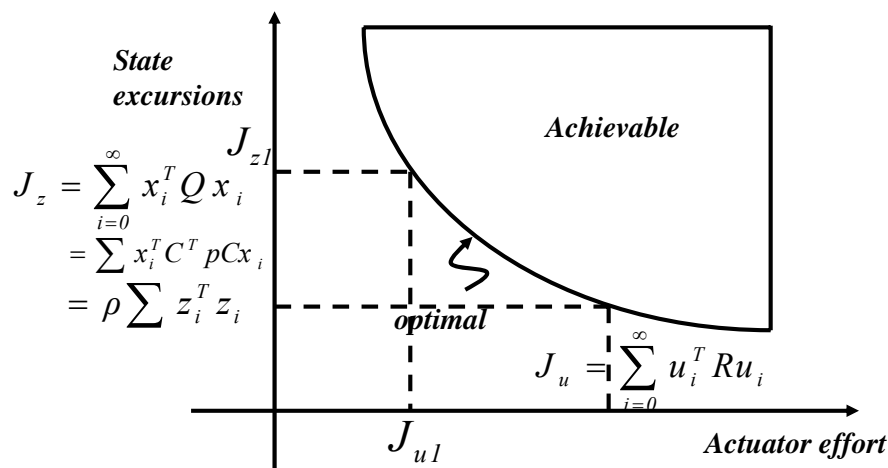

4.6 Optimal Linear Estimation

Our optimal control has the form $u_{opt}(k) = -K(k)x_{opt}(k)$

This assumes that we have complete state Information $x_{opt}(k)$ -not actually true!.
e.g: in SHO, we might have only a Position sensor but Not a velocity sensor.

How can we obtain “good“ estimates of the velocity state from just observing the position state?

Furthermore the Sensors may be noisy and the plant itself may be subject to outside disturbances (process noise) i.e. we are looking for this:

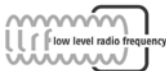
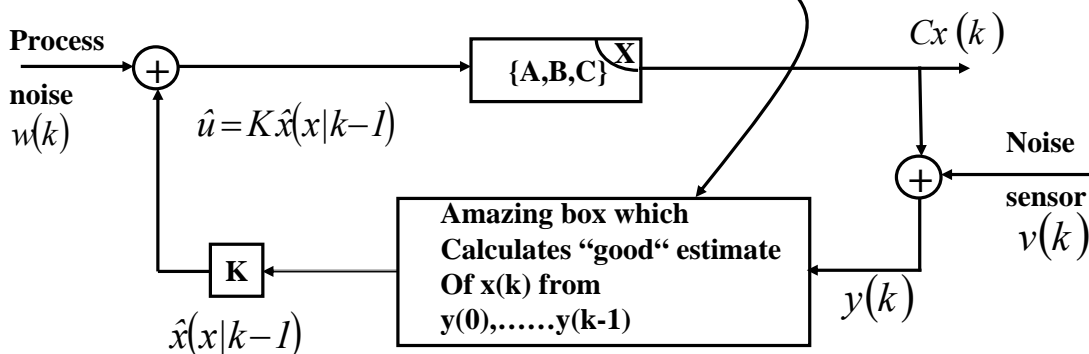

4.6 Problem Statement :

$$x(k+1) = Ax(k) + Bw(k)$$

$$z(k) = Cx(k)$$

$$y(k) = Cx(k) + v(k)$$

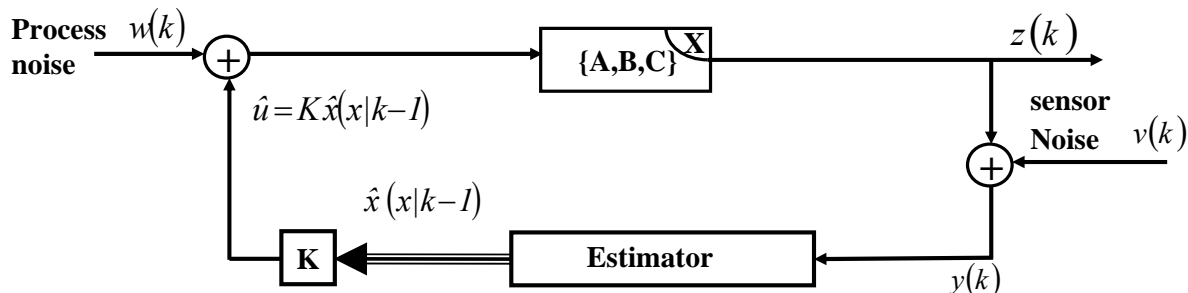

Assume also $x(0)$ is Random & Gaussian and that $x(k)$, $w(k) + V(k)$ are all mutually Independent for all k.

Find: $\hat{x}(k|k-1)$ Optimal estimate of $x(k)$ given y_0, \dots, y_{k-1}

Such that “mean squared error“

$$E \left[\|x(k) - \hat{x}(k|k-1)\|_2^2 \right] = \text{minimal}$$

Fact from statistics: $\hat{x}(k|k-1) = E[x(k) | (y_0, \dots, y_{k-1})]$

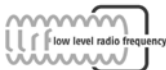

4.6 Kalman Filter

The Kalman filter is an efficient algorithm that computes the new $\hat{x}_{i+1|i}$ (the linear-least-mean (square estimate) of the system state vector x_{i+1} , given $\{y_0, \dots, y_i\}$, by updating the old estimate $\hat{x}_{i|i-1}$ and old $\tilde{x}_{i|i-1}$ (error).

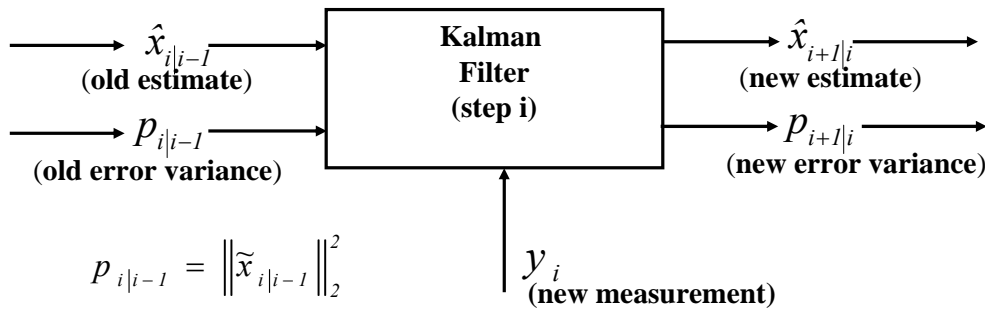

The Kalman Filter produces $\hat{x}_{i+1|i}$ from $\hat{x}_{i|i-1}$ (rather than $\hat{x}_{i|i}$), because it “tracks” the system “dynamics”. By the time we compute $\hat{x}_{i|i}$ from $\hat{x}_{i|i-1}$, the system state has changed from

$$x_i \text{ to } x_{i+1} = Ax_i + Bw_i$$

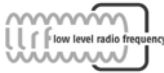

4.6 Kalman Filter

The Kalman Filter algorithm can be divided in a measurement update and a time update:

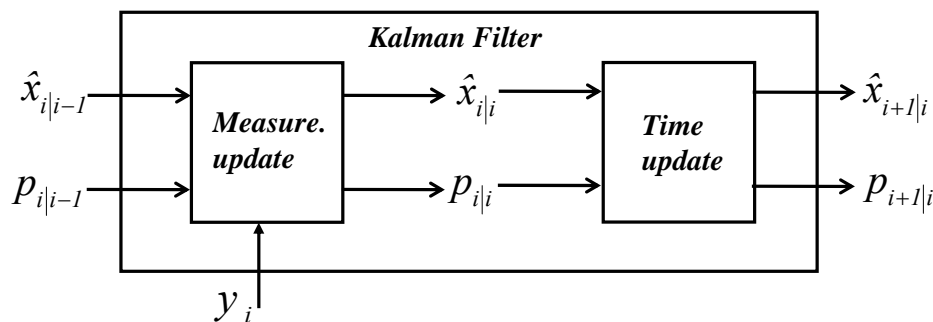

Measurement update (M.U.):

$$\hat{x}_{i|i} = \hat{x}_{i|i-1} + p_{i|i-1} C^T (C p_{i|i-1} C^T + V)^{-1} (y_i - C \hat{x}_{i|i-1})$$

$$p_{i|i} = p_{i|i-1} - p_{i|i-1} C^T (C p_{i|i-1} C^T + V)^{-1} C p_{i|i-1}$$

Time Update (T.U.):

$$\hat{x}_{i+1|i} = A \hat{x}_{i|i}$$

$$p_{i+1|i} = A p_{i|i} A^T + B W B^T$$

With initial conditions:

$$\hat{x}_{0|-1} = 0$$

$$\hat{p}_{0|-1} = X_0$$

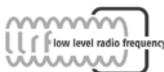

4.6 Kalman Filter

By pluggin M.U. equations into T.U. equations. One can do both steps at once:

$$\begin{aligned}\hat{x}_{i+1|i} &= A\hat{x}_{i|i} \\ &= A\hat{x}_{i|i-1} + Ap_{i|i-1}C^T(Cp_{i|i-1}C^T + V)^{-1}(y_i - C\hat{x}_{i|i-1})\end{aligned}$$

$$\hat{x}_{i+1|i} = A\hat{x}_{i|i-1} + L_i(y_i - C\hat{x}_{i|i-1})$$

where $L_i \equiv A(p_{i|i-1}C^T(Cp_{i|i-1}C^T + V)^{-1})$

$$\begin{aligned}p_{i+1|i} &= Ap_{i|i}A^T + BWB^T \\ &= A\left[p_{i|i-1} - p_{i|i-1}C^T(Cp_{i|i-1}C^T + V)^{-1}Cp_{i|i-1}\right]A^T + BWB^T\end{aligned}$$

$$p_{i+1|i} = Ap_{i|i}A^T + BWB^T - Ap_{i|i-1}C^T(Cp_{i|i-1}C^T + V)^{-1}(Cp_{i|i-1} - I)A^T$$

Known as discrete time Riccati Equation

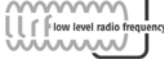

4.6 Picture of Kalman Filter

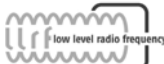
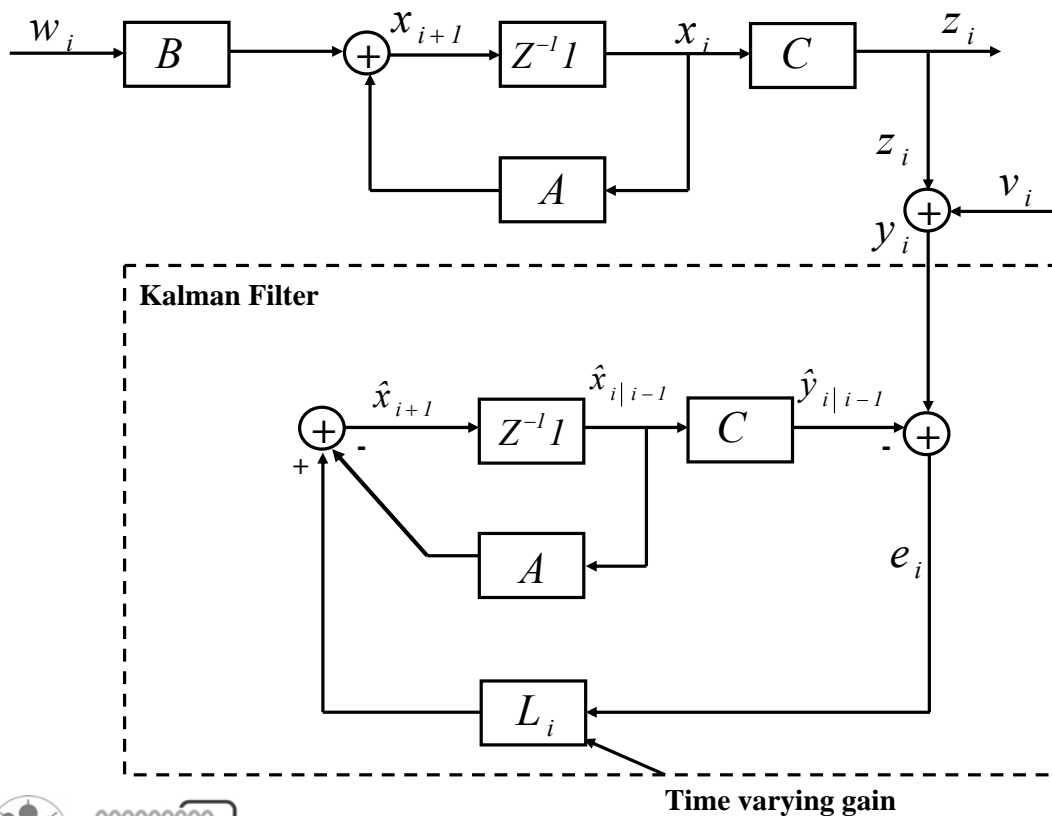

4.6 Picture of Kalman Filter

Plant Equations:

$$\begin{aligned}x_{i+1} &= Ax_i + Bu_i \\y_i &= Cx_i + v_i\end{aligned}$$

Kalman Filter:

$$\begin{aligned}\hat{x}_{i+1|i} &= A\hat{x}_{i|i-1} + L_i(y_i - \hat{y}_{i|i-1}) \\y_{i|i-1} &= C\hat{x}_{i|i-1}\end{aligned}$$

If $v=w=0 \Rightarrow$ Kalman filter can estimate the state precisely in a finite number of steps.



4.6 Kalman Filter

Remarks:

(1) Since $y_i = Cx_i + v_i$ and $\hat{y}_{i|i-1} = C\hat{x}_{i|i-1}$ can write estimator equation as

$$\begin{aligned}\hat{x}_{i+1|i} &= A\hat{x}_{i|i-1} + L_i(Cx_i + v_i - C\hat{x}_{i|i-1}) \\&= (A - L_iC)\hat{x}_{i|i-1} + L_iCx_i + v_i\end{aligned}$$

can combine this with equation for x_{i+1}

$$\begin{aligned}\begin{bmatrix} x_{i+1} \\ \hat{x}_{i+1|i} \end{bmatrix} &= \begin{bmatrix} A & 0 \\ L_iC & A - L_iC \end{bmatrix} \begin{bmatrix} x_i \\ \hat{x}_{i|i-1} \end{bmatrix} + \begin{bmatrix} B & 0 \\ 0 & 1 \end{bmatrix} \begin{bmatrix} w_i \\ v_i \end{bmatrix} \\ \begin{bmatrix} z_i \\ \hat{y}_{i|i-1} \end{bmatrix} &= \begin{bmatrix} C & 0 \\ 0 & C \end{bmatrix} \begin{bmatrix} x_i \\ \hat{x}_{i|i-1} \end{bmatrix}\end{aligned}$$

(2) In practice, Riccati equation reaches steady state in few steps. People often run with steady-state K.F.i.e

$$\begin{aligned}\text{Where } L_{ss} &= Ap_{ss}C^T(Cp_{ss}C^T + V)^{-1} \\ p_{ss} &= Ap_{ss}A^T + BWB^T - Ap_{ss}C^T(Cp_{ss}C^T + V)^{-1}Cp_{ss}A\end{aligned}$$

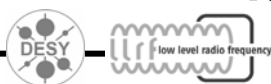

4.7 LQG Problem

Now we are finally ready to solve the full control problem.

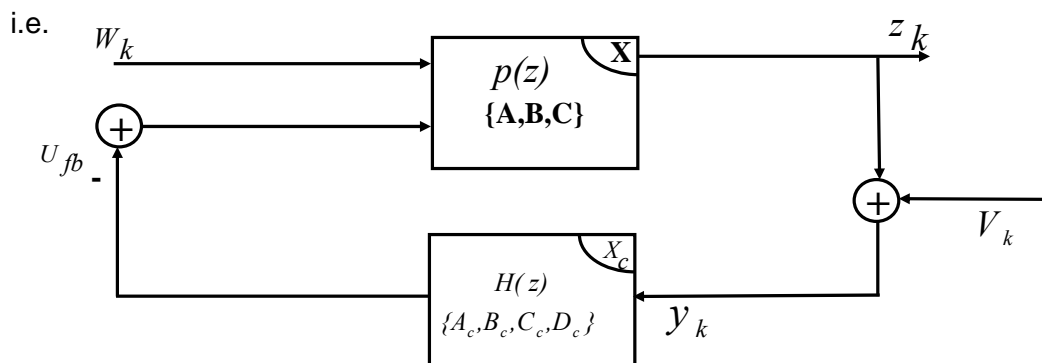

Given: $x_{k+1} = Ax_k + Bu_k + B_w w_k$

$$z_k = Cx_k$$

$$y_k = Cx_k + v_k$$

$$\langle w_i, w_j \rangle = W \delta_{ij}, \quad \langle v_i, v_j \rangle = V \delta_{ij}$$

$$\langle w_i, v_j \rangle = 0$$

w_k, v_k both Gaussian

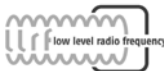

For Gaussian, K.L. gives the absolute best estimate

87

CAS-DSP, Sigtuna 2007-Control Theory-S. Simrock

4.7 LQG problem

Separation principle: (we won't prove)

The separation principle states that the LQG optimal controller is obtained by:

(1) Using Kalman filter to obtain least squares optimal estimate of the plant state,

i.e.: Let $x_c(k) = \hat{x}_{k|k-1}$

(2) Feedback estimated LQR- optimal state feedback

$$\begin{aligned} u(k) &= -K_{LQR} x_c(k) \\ &= -K_{LQR} \hat{x}_{k|k-1} \end{aligned}$$

i.e. can treat problems of

-Optimal feedback and

-state estimate

separately.

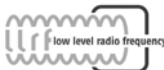

CAS-DSP, Sigtuna 2007-Control Theory-S. Simrock

88

4.7 Picture of LQG Regulator

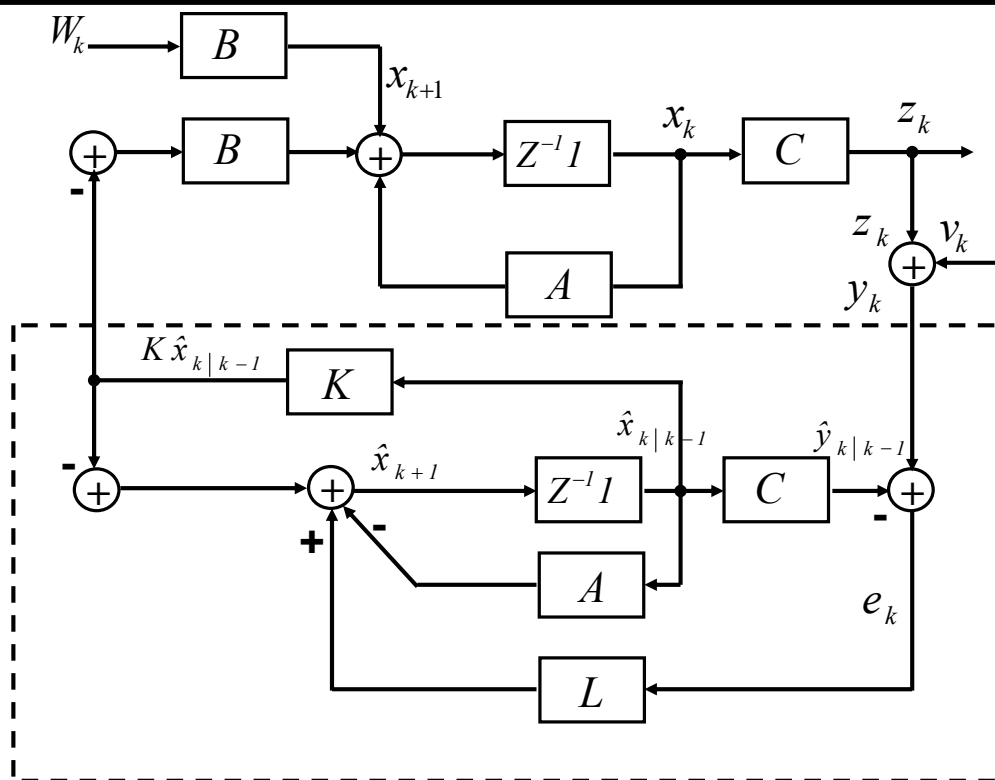

4.7 LQG Regulator

Plant

$$\begin{cases} x_{k+1} = Ax_k + (-Bu_k) + B_w w_k \\ z_k = Cx_k \\ y_k = Cx_k + v_k \end{cases}$$

LQG Controller

$$\begin{cases} \hat{x}_{k+1|k} = A\hat{x}_{k|k-1} + Bu_k + L(y_k - C\hat{x}_{k|k-1}) \\ u_k = -K\hat{x}_{k|k-1} \end{cases}$$

$$k = -[R + B^T S B]^{-1} + S = A^T S A + Q - A^T S B [R + B^T S B]^{-1} B^T S A$$

$$L = A P C^T [V + C P C^T]^{-1} + P$$

$$= A P A^T + B W B^T - A P C^T [V + C P C^T]^{-1} C P C^T$$

4.7 Problem Statement (in English)

Want a controller which takes as **input** noisy measurements, y , and produces as **output** a Feedback signal u , which will minimize excursions of the regulated plant outputs (if no pole-zero cancellation, then this is equivalent to minimizing state excursions.)

Also want to achieve “regulation” with as little actuator effort u , as possible.

Problem statement (Mathematically)

Find: Controller
$$H(z) = C_c (zI - A_c)^{-1} B_c + D_c$$

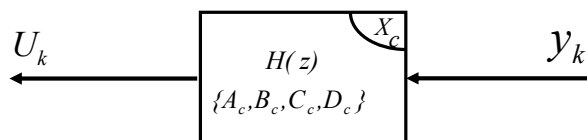

Controller:
$$x_c(k+1) = A_c x_c(k) + B_c y(k)$$

$$y_c(k) = C_c x_c(k)$$

Which will minimize the cost

$$J_{LQG} = \lim_{k \rightarrow \infty} E \left[\underbrace{x_k^T Q x_k}_{\text{Rms "state" excursions}} + \underbrace{u_k^T R u_k}_{\text{Rms "actuator" effort}} \right]$$

Where

Plant
$$x_{k+1} = A x_k + (-B u_k) + B_w w_k$$

$$z_k = C x_k$$

$$y_k = C x_k + v_k$$

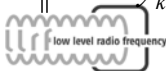

4.7 Problem Statement

Remarks:

- (1). Q and R are weighing matrices that allow trading off of rms u and rms x .
- (2) if $Q = C^T \rho C; \rho > 0$ then trade off rms z VS rms u
- (3). In the stochastic LQR case, the only difference is that now we don't have complete state information $y_i = C x_i + v_i$ we have only noisy observations

i . e **can't** use full state feedback.

Idea: Could we use estimated state Feedback? (i.e. $-K \hat{x}_{k|k-1}$)

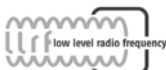

4.7 Problem Statement

(5) We can let Q/R ratio vary and we'll obtain family of LQG controllers. Can Plot rms z vs rms u for each one

→ **Trade-Off curves**

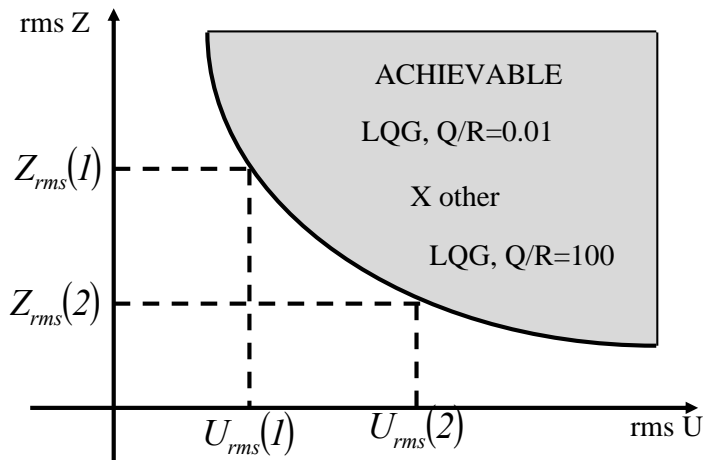

So by specifying (1) system model, (2) noise variances, (3) optimally criterion J_{LQG} , and plotting trade off curve completely specifies limit of performance of

System i. e which combinations of (Z_{rms}, U_{rms}) are achievable by any controller -good "benchmark curve".

