



Installation Overview

Fred Asiri/SLAC

Acknowledgment:

F. Peters, M. Munro, J. Kim

G. Aarons, C. Corvin, P. Rodriguez

- Installation activities covers a large geographical area
 - approximately 31 linear kilometers long which includes a complex network of about 72 km of underground tunnels at the depth of approximately 100m
- Requires the installation of
 - ~2,000 cryomodules, over 13,000 magnets and approximately 650 high level RF stations

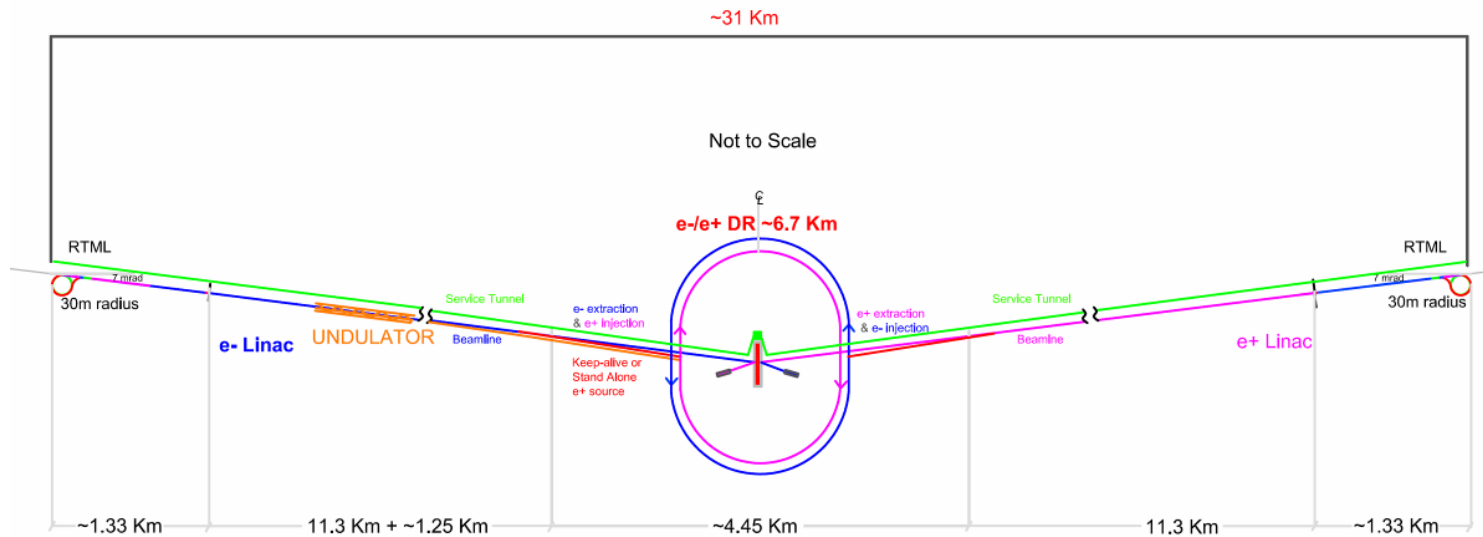

Schematic Layout - Plan View of the 500 GeV Machine



Status of WBS 1.7.3 Installation

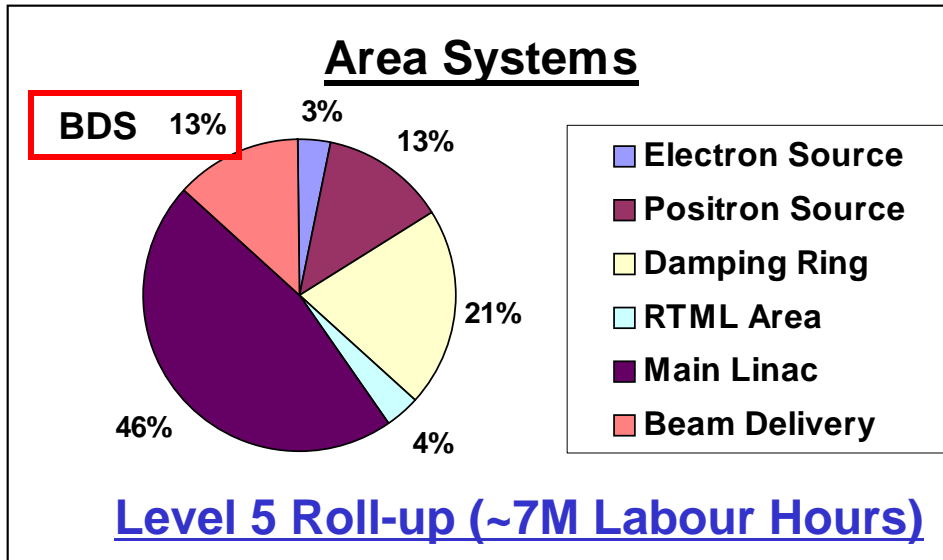
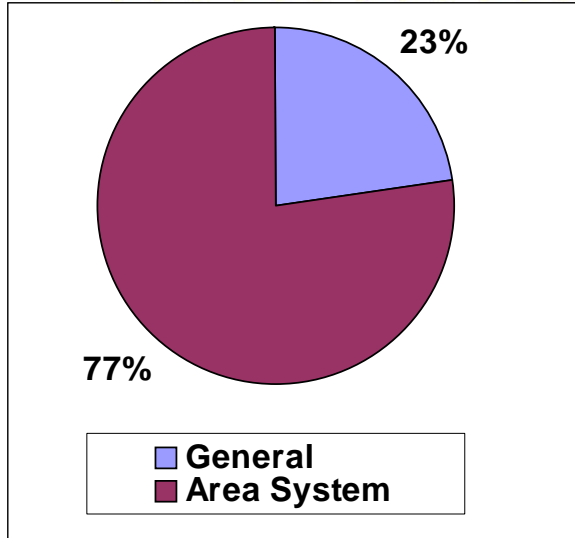

WBS				Component
1	7	3		Installation
1	7	3	1	General Installation
			1	Logistics Management
			2	Engineering Support
			3	Equipment
			4	Vehicles
			5	Shipping-Receiving
			6	Warehousing
			7	Surface Transport
1	7	3	2	Area System Installation
			1	Sources e- Area Installation
			2	Sources e+ Area Installation
			3	Damping Ring Area Installation
			4	RTML Area Installation
			5	Main Linac Area Installation
			6	Beam Delivery Area Installation



Current Status of Central Area

BDS Large/Heavy Equipments Installation Access Shafts (9m ID)

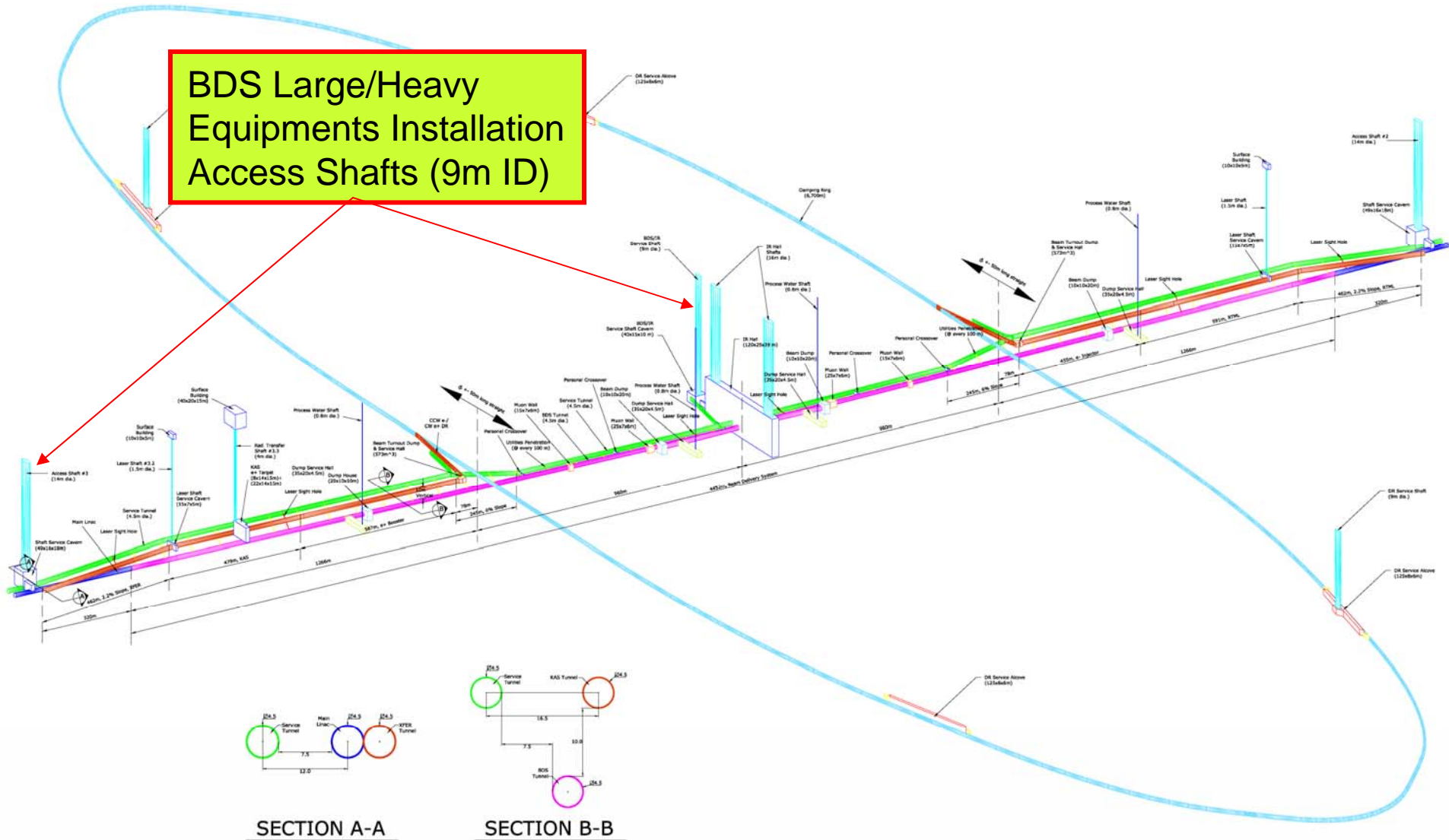

SECTION A-A

SECTION B-B



ILC Magnet Count for the Area Systems

Magnet Type	Grand Totals		Sources			Damping Rings				2 RTML		2 Linacs		2 BeamDel		
	Styles	Quantity	Style	e- Qty	e+ Qty	Style	e-DR Qty	e+DR Qty	e- Inj/Ext Qty	e+ Inj/Ext Qty	Style	Qty	Style	Qty	Style	Qty
Dipole	22	1351	6	25	152	2	126	126	8	8	6	716	0	0	8	190
Normal Cond Quad	37	4134	13	76	840	4	747	747	76	76	5	1368	0	0	15	204
Supercond Quad	16	715	3	16	51	0	0	0	0	0	0	56	3	560	10	32
Sextupole	7	1050	2	0	32	2	504	504	0	0	0	0	0	0	3	10
Supercond Sextupole	4	12	0	0	0	0	0	0	0	0	0	0	0	0	4	12
Normal cond Solenoid	3	38	3	12	26	0	0	0	0	0	0	0	0	0	0	0
Supercond Solenoid	4	14	1	2	0	0	0	0	0	0	1	8	0	0	2	4
Normal cond Corrector	9	3836	1	0	840	3	450	450	0	0	4	2032	0	0	1	64
Supercond Corrector	14	1374	0	32	102	0	0	0	0	0	0	84	2	1120	12	36
Pulsed/Kickers/Septa	13	319	1	0	21	4	68	68	0	0	3	70	0	0	5	92
Supercond Wiggler	1	160	0	0	0	1	80	80	0	0	0	0	0	0	0	0
NC Octupole/Muon Spoilers	2	6	0	0	0	0	0	0	0	0	0	0	0	0	2	6
Supercond Octupole	3	14	0	0	0	0	0	0	0	0	0	0	0	0	3	14
Supercond Undulator	1	27	1	0	27	0	0	0	0	0	0	0	0	0	0	0
Overall Totals	136	13050	31	163	2091	16	1975	1975	84	84	19	4334	5	1680	65	664
Totals w/o correctors	113	7840	ILC Magnet count for 250Gev on 250Gev beams with Interim Working Assumptions configuration													
Total Normal cond	93	10734	FINAL QUANTITIES for the Reference Design Report													
Total Superconducting	43	2316	~18% of all magnets are superconducting													

8Dec06 version

Compiled by Cherrill Spencer, ILC Magnet Systems Group. Send updated quantities to her.

Some cells you will see a quantity with zero styles-because same style is used in more than one area and style is counted in just one area.



Scope of Installation

- Covers all activities required to:
 - **prepare, coordinate, integrate, and execute a detailed plan for the complete installation of the ILC Technical Systems Components as well as associated site-wide logistics**
- Includes all labor, materials and equipment required to;
 - **receive, transport, situate, affix, accurately position, interconnect, integrate, and checkout all components and hardware from a central storage or subassembly facility to its operational location within the Beam and Service tunnels**
- Does not include:
 - **fabrication, assembly, component quality control and commissioning.**
- Elements of the installation system
 - **Range from complex subassemblies to single items**
 - **Highest stage of pre-assembly prior to installation**
 - **Components are to be bundled into installation kits, which include all supports and hardware required to affix and interconnect the components in their operational**

One of 556 Main Linac (RF) Unit

~ 38 Meter

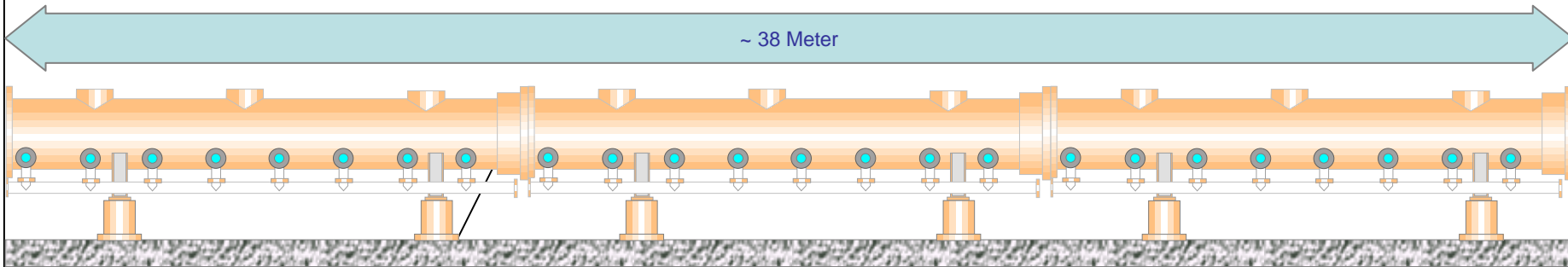

Module Connections

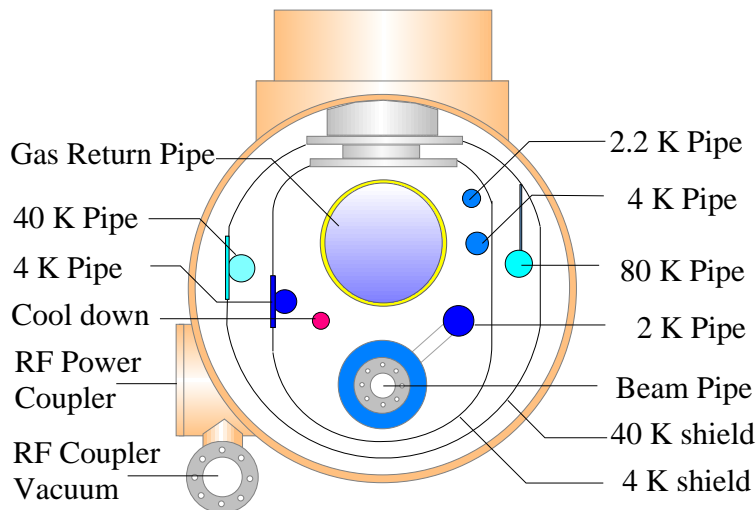

Installation Sequence

- Prepare tunnel section for installation...
- Move, place, adjust and fix Cryomodule supports...
- Move Cryomodules from access shaft to installation section...
- Install, adjust, fix, and prepare section for Cryogenic & Beam Pipe connections...
- Complete Cryogenic and Vacuum connections, leak check, then connect the Cryomodule sleeve coupling



Cryomodule Installation – Assumptions

Cryomodule Connections

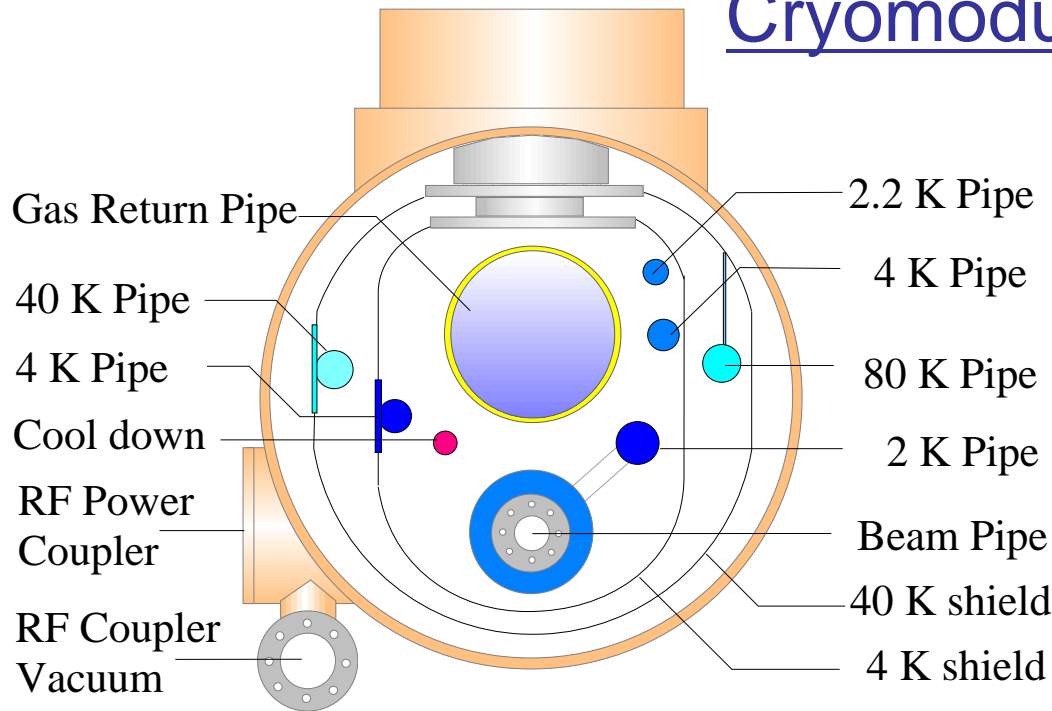

Pipe welding procedure e.g.:

Prepare joints, tools, etc.

1. Place welding machine
2. Check setup with one test run
3. Execute welding procedure
4. Remove welding machine
5. Setup visual control monitor
6. Execute control procedure
7. Remove control monitor
8. Go to next pipe

Use:

- **10 man-days per interconnect for cryogenic pipes and superconducting joints, Tom Peterson, 11/9/2006**
- **7 man-days per connection for vacuum joints, John Noonan, 11/9/2006**



Cryomodule Installation – Assumptions

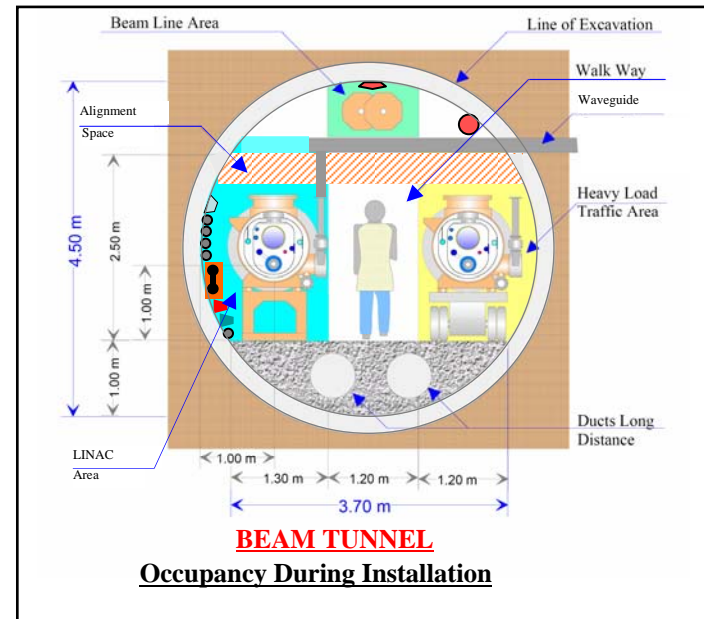
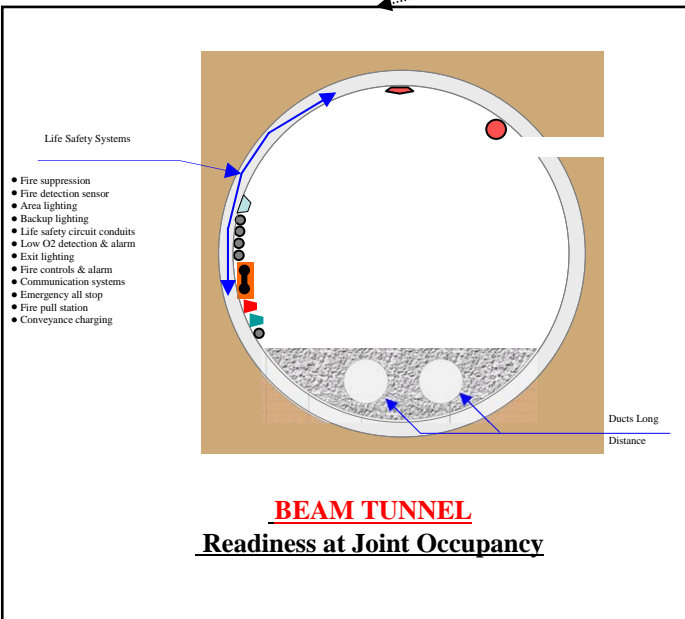
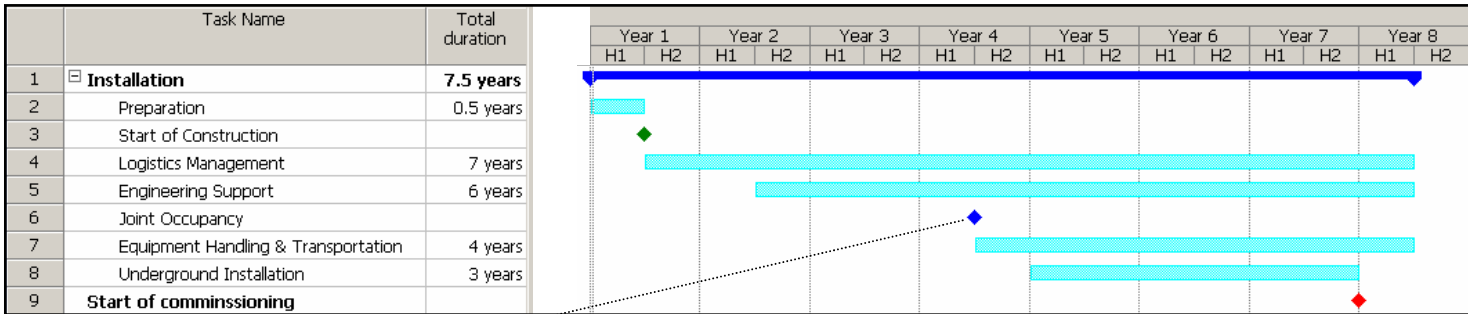



Installation Planning Model

Installation planning of the large and complex ILC machine requires the creation of 3-D computer models of all the major components as well as the underground works.

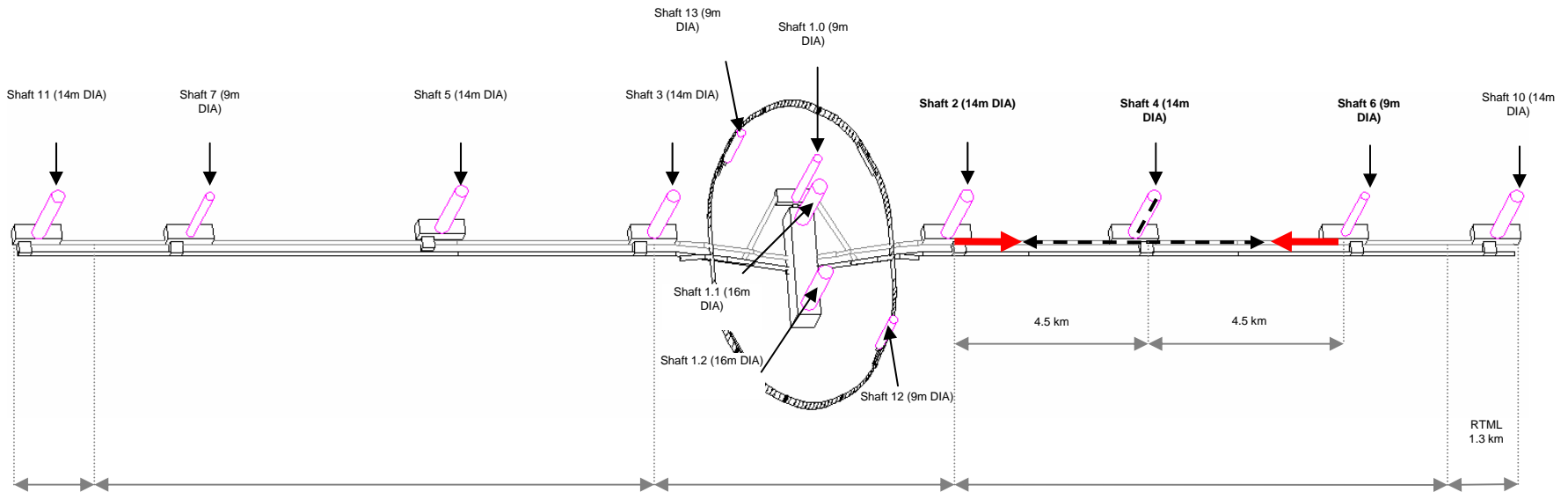

Underground Layout with Installation Access Shafts



Installation Model for Main Linac Components in Underground Segment

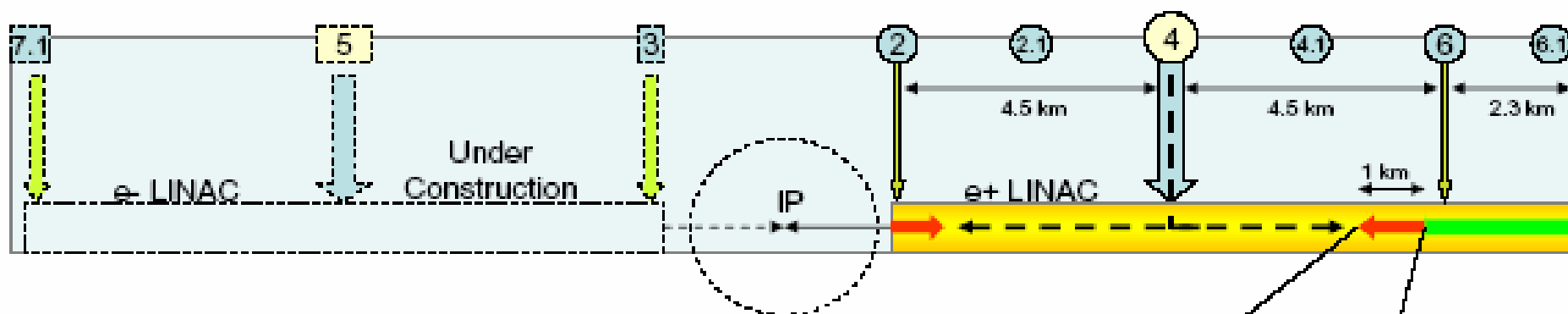

Legend

- 4 Heavy equipment staging & access shaft
- 2 6 Small equipment & people access shafts
- -> Heavy equipment transport zone only
- ← Installation flow direction
- Machine installed & people activity

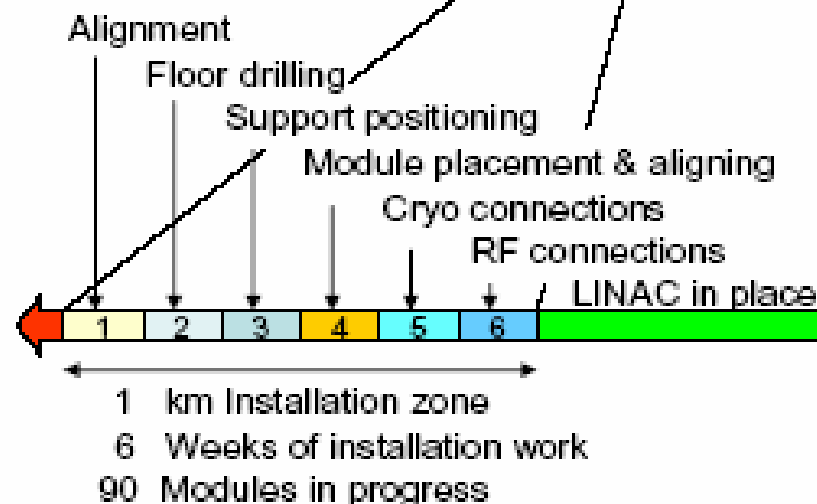

Installation Sequence

**Installation of BDS Major Components (e.g. Magnets)
Modeled and Scaled Based on the Cryomodules**



EDR PLANNING

- Refine the 3D drawings of the tunnel and insert brief overall drawings of the technical equipment and integrate with a time and motion software
- Superimpose the surface warehouses, the staging assembly buildings and the elevator access shafts
- Prepare alternate installation approach systems, to facilitate the best way to perform the installation
- Evaluate elevator transport options for materials, to support installation activities
- Design the main material transport system, for accelerator part movement, in the tunnel, then manufacture and test, a prototype vehicle
- Check out utility access locations for an efficient installation
- Build a mockup of a tunnel section and using outline models of the most difficult pieces of accelerator equipment to install, go through the installation procedures, to proof out the material handling equipment and fixtures/tooling to be used
- The mockup could also be used as an installation training site and for the evaluation of safety procedures
- Define support equipment required. This will include vacuum support equipment, such as leak checkers, materials handling equipment, fixtures, tooling, etc.



Major inputs required for the underground installation

- Basic civil engineering layouts of the facility, including surface building locations, access roads & tunnel layouts.
- Preliminary outline drawings of the various pieces of equipment to be installed in the tunnel. These details should include mechanical, electrical & utility equipment requirements.
- Details of the physical locations of all pieces, of equipment to be placed in the tunnel.
- Location of all utility connections in the tunnel.
- Cryogenic system connection box locations, in the tunnel.
- Develop flow charts, showing the typical sequence of events, per major equipment item, in the installation process.
- Approximate schedule of facility completion, plus delivery dates & sequence of equipment deliveries to the site.
- An inventory control system that incorporates input data, output data & documentation.
- Safety/emergency features in the tunnel & on the surface.
- Details of the quality & quantity of local labor available, to support the installation.



EDR PLANNING

Data Processing:

- An inventory control system to cover, receiving, scheduling, installation planning & documentation reproduction, will be required. This type information should be readily accessible, at many points on the site.
- Quick part data identification, can enhance our ability, to perform the installation. Several types of part identification equipment are available, including RFID, Data Matrix & Bar Coding; these should be evaluated regarding the site requirements, as some of them need relatively expensive writers & readers, plus some vendors, may not have this capability



Added Values

- Centralized information database
 - **Sharing and synchronization of records, files**
- Easy and fast communication
- Better-informed planning decisions from
 - **Operation optimization**
 - Feasibility study with resource loaded production plan
 - Global optimization
 - **Interference detection**
 - Physical interferences detection
 - Work space conflicts detection
 - Analysis of the severity of the interferences and conflicts
- Real-time tracking and reporting
 - **Status check for individual equipment**
 - Fabrication, transit, storage, sub-assembly, installation
- Comparison between planned and actual



Application of Virtual Design & Construction Technologies

Fabricator

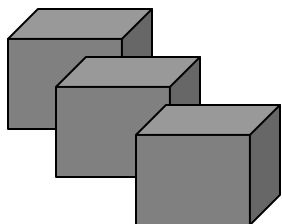

Transporter



Job Site

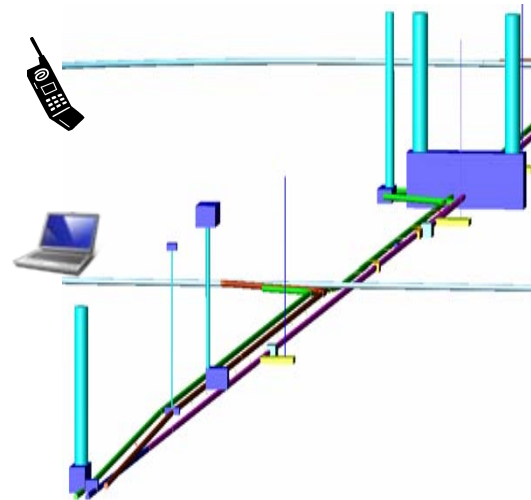

Mobile Technology

*4D Technology
(3D CAD + schedule)*

4D model /
interference check
(NavisWorks)

Scheduling
(Primavera)

3D model
(AutoCAD)

Mobile
Server

Integrated
Central
4D Database
(Enterprise)

*Database
Technology*

*Operation
Optimization*

Discrete event
simulation
(Strobscope)



EDR/FY08 Budgetary Plan

- Goal: To set up a logistics management database for the ILC to accomplish and optimize the installation process management
 1. **Set-up a Data Base software to**
 - Define scope of on site deliverable for each subsystem
 - Define the subsystem installation requirements
 - Establish subsystem interfaces/Boundaries
 2. **Set-up and launch a 4D computer software program (CATIA) to integrate 3D geometry with time motion simulation**
 - Check for space time conflict management
 - Maximize efficiency, labor loading, and material delivery sequencing

	April Budget Plan		Reduced Budget Model	
WBS Level	FTEs	M&S	FTEs	M&S
WBS 2.2.3.1 Installation	2.0	120	1.75	0