

Multipacting Simulation Using Parallel Code Track3P

Lixin Ge

**Advanced Computations Department
SLAC**



OVERVIEW

- Introduction
 - **Background**
 - **Code development**
- Track3P Benchmark
 - **Comparison with theory**
 - **Comparison with experiment**
- Applications
 - **TTF-III coupler and its components**
 - **SNS coupler**
- Summary



Background

- **Multipacting is a phenomenon of**
 - Resonant electron multiplication in the particle accelerators
 - A large number of electrons build up an electron avalanche
- **Multipacting Result**
 - Leading to power losses and heating of the walls
 - Impossible to increase the cavity fields by rising the incident power
- **Multipacting simulation require**
 - High resolution EM Field
 - Tracking code with curve surface information
 - Accurate Second Emission Yield curve



Code Development

- Omega3P and S3P are **high resolution** code with hierarchical basis function up to 6th order
- Track3P is a tracking code with **high fidelity** geometry information.

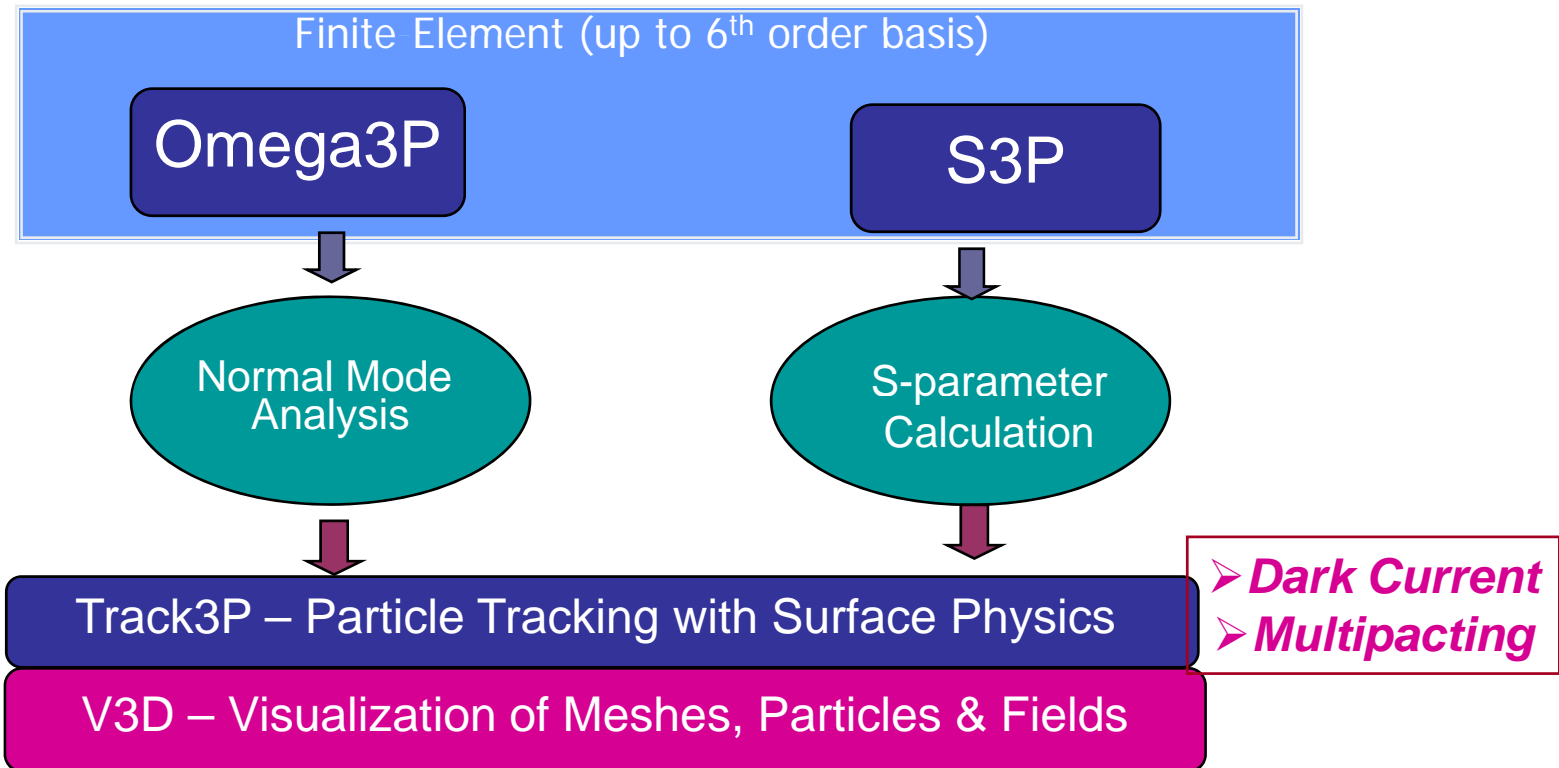

Track3P Benchmark

- **Comparison with theory**
- **Comparison with measurement**



Track3P Benchmark: Comparison with Theory



The multipacting powers obey the following scaling laws (E. Somersalo. et al)

Standing wave: $P_{one-point} \sim (fd)^4 Z$

Traveling wave: $P_{TW} = 4P_{SW}$

order	Ln(p)	Power(SW, KW)	Power(TW, KW)
1	6.6	735.0919	2940.368
2	6	403.4272	1613.709
3	5.4	221.4056	885.6224
4	4.9	134.2893	537.1573
5	4.5	90.01686	360.0674
6	4.2	66.68614	266.7446
7	3.8	44.70107	178.8043
8	3.6	36.59815	146.3926

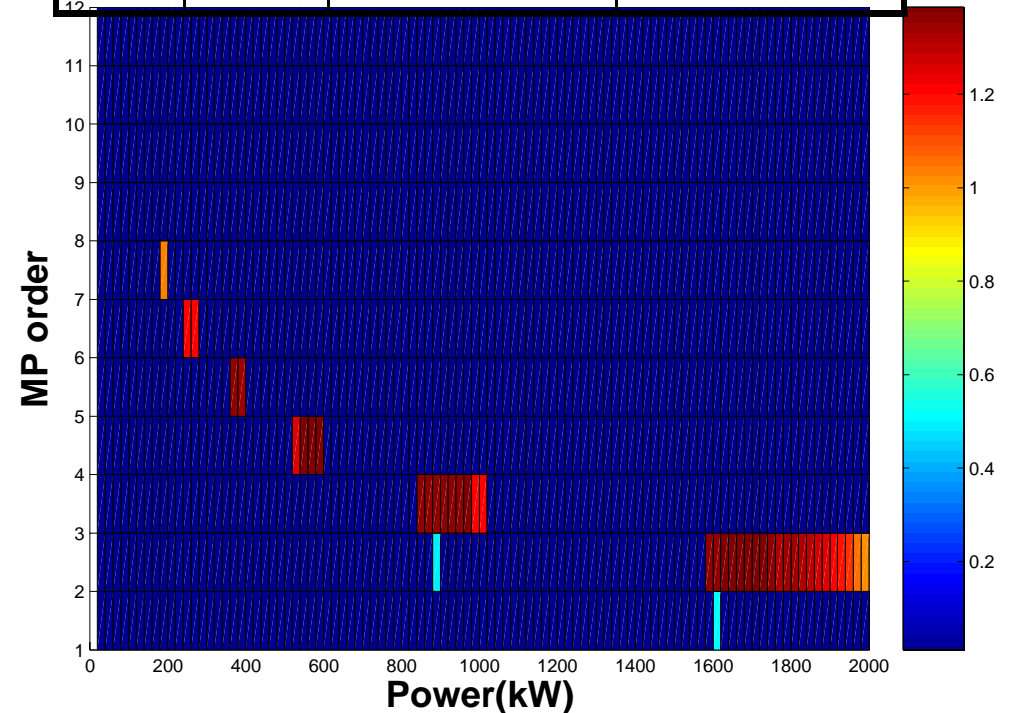
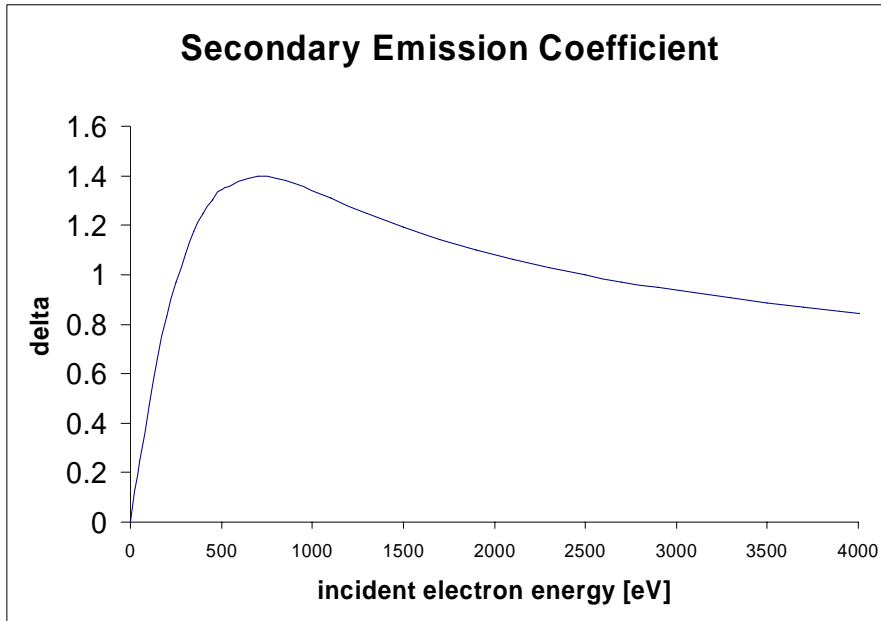

Track3P Benchmark: Comparison with experiment - MP simulation on ICHIRO Cavity

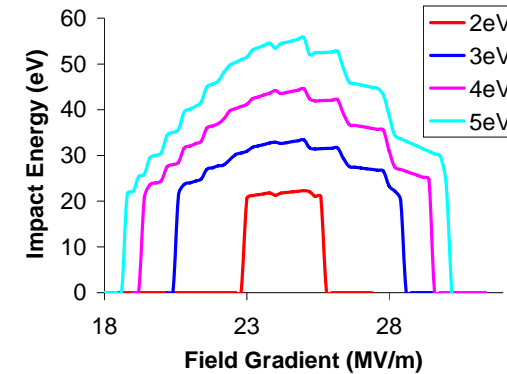
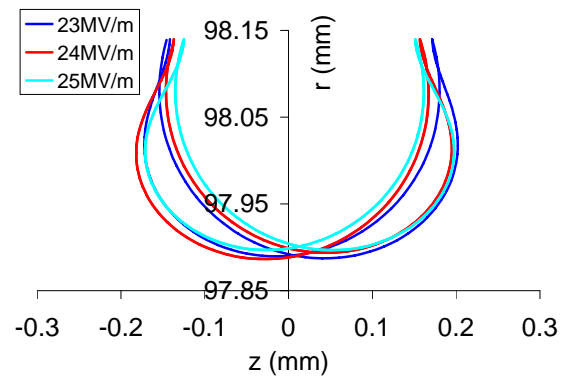

MP trajectories (left) and barriers (right) in regular SRF cells.
Soft barrier at around 23MV/m agrees with RF tests.

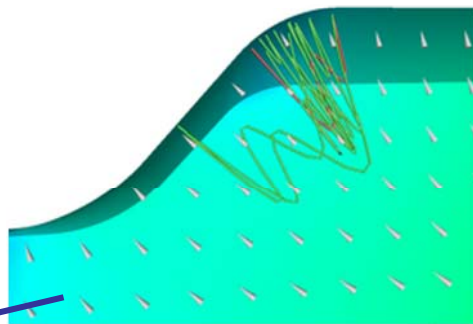

Track3P MP simulation		ICHIRO #0 (K. Saito, KEK)
Impact Energy (eV)	Gradient (MV/m)	X-ray Barriers (MV/m)
300-400(6 order)	12	11-29.3 12-18
200-500 (5 order)	14	13, 14, 14-18, 13-27
300-500(3 order)	17	(17, 18)
300-900(3 order)	21.2	20.8
600-1000(1.5 order)	29.4	28.7, 29.0, 29.3, 29.4

MP barriers in the beam pipe step region

Applications

- **Cavities**
 - TESLA-ILC, LL, Reentrant, ICHIRO and SNS.....
- **Couplers**
 - ICHIRO, TTFIII, LBSK, CPC, SNS

MP simulations on TTF3 coupler



TTFIII Coupler Test Setup

simulate all the components to compare with and to help understand the HP test results

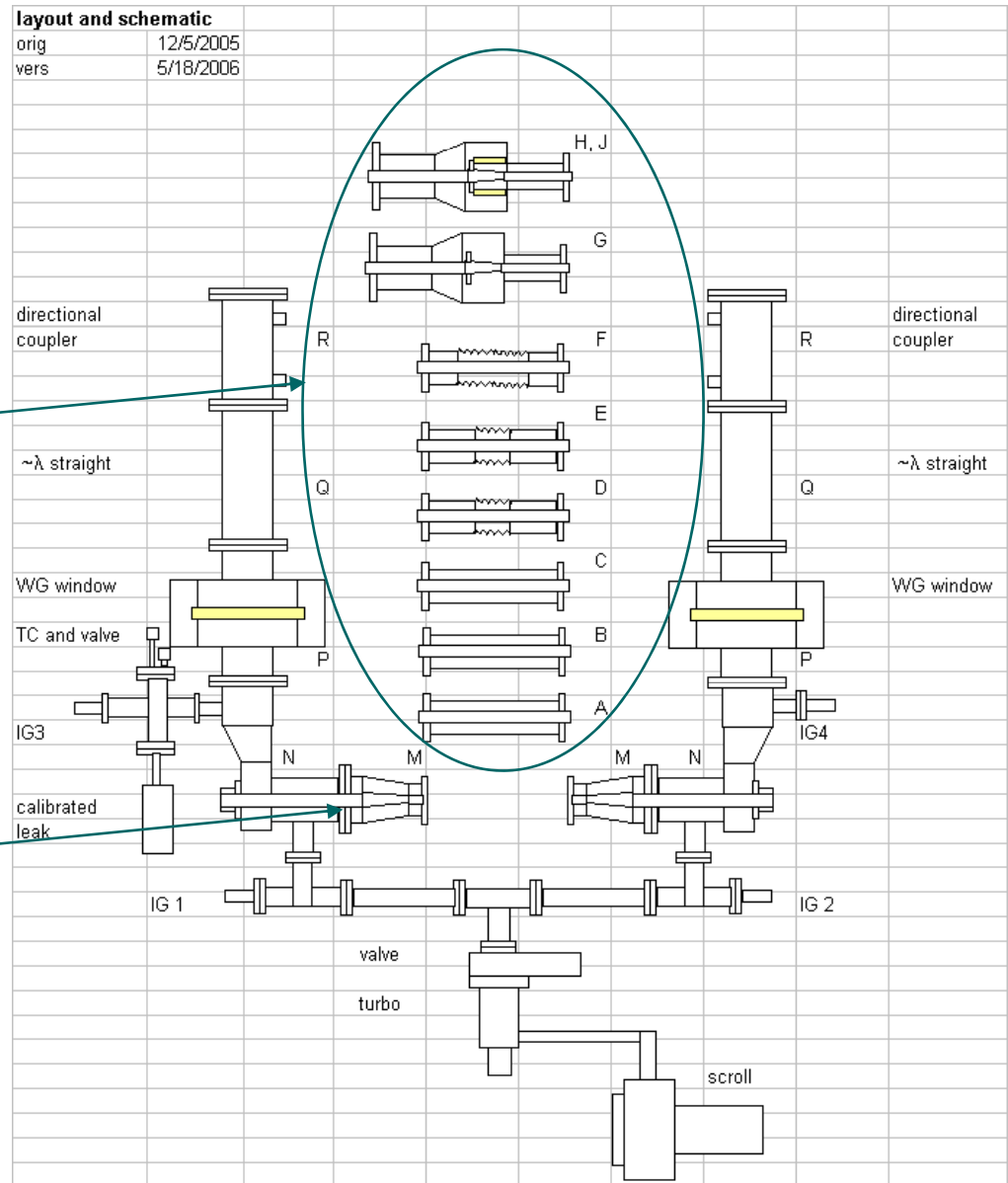
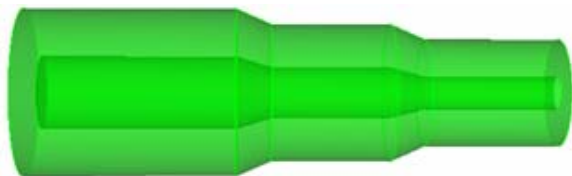
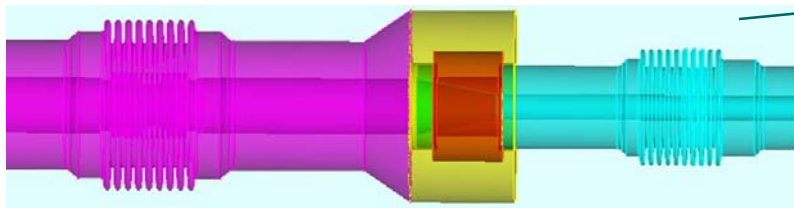

TTF3 Multipacting Simulation Components

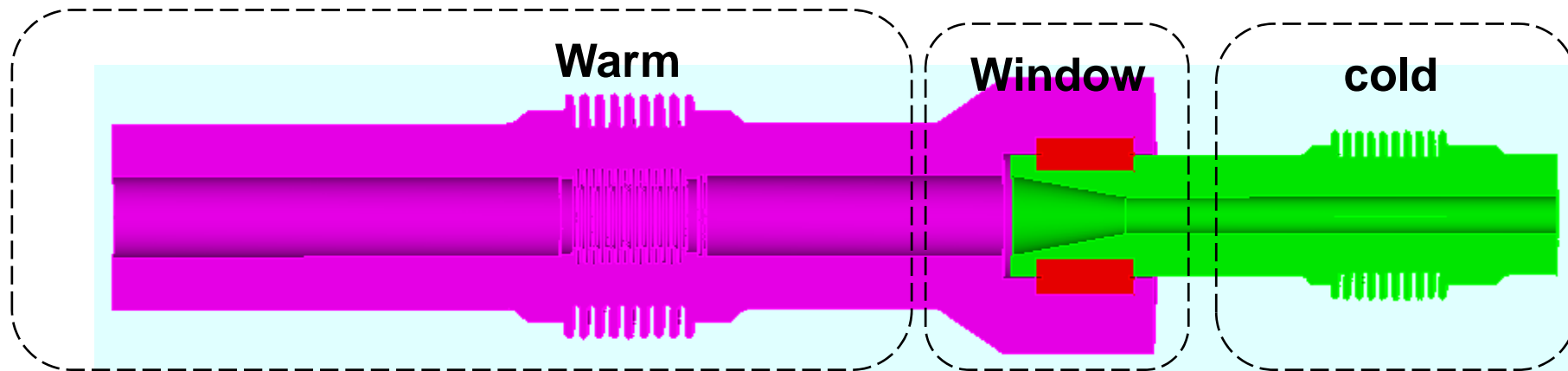

Taper Region

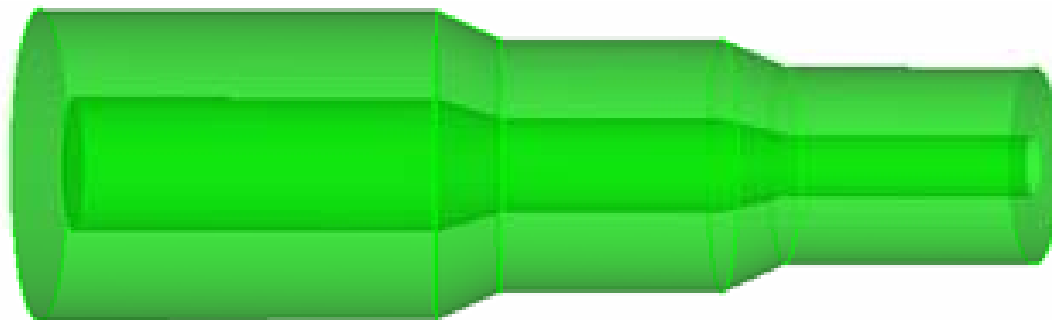

Input Power: 0-2MW, Scan interval: 50KW.

Cold Coax

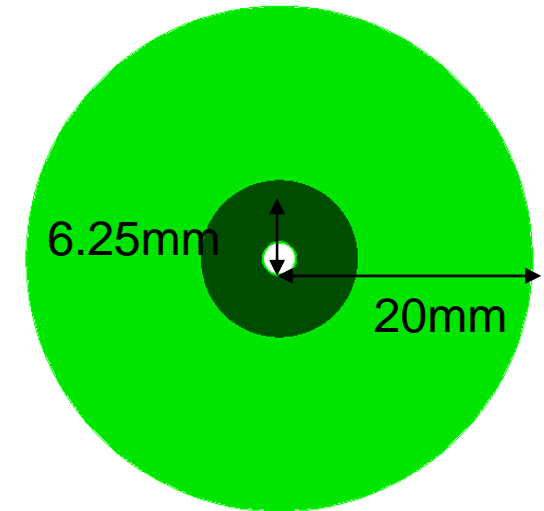
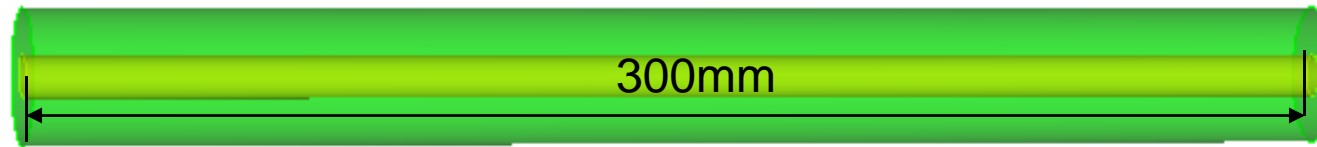

Simulation Cases:

1. with/without reflection
2. with/without external magnetic field
3. with variable center conductor DC biases

Conclusions:

Our multipacting simulation results are in excellent agreement with theoretical calculations and experiment measurements at SLAC.

Cold Coax (continued)

Reflection: 0.0

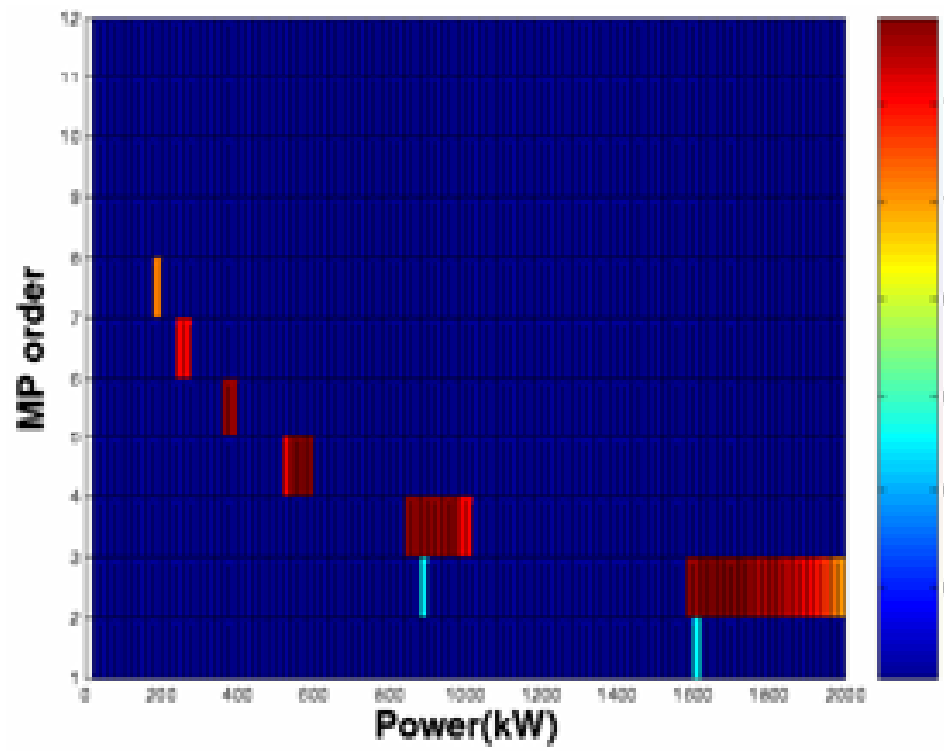

Reflection: 0.5

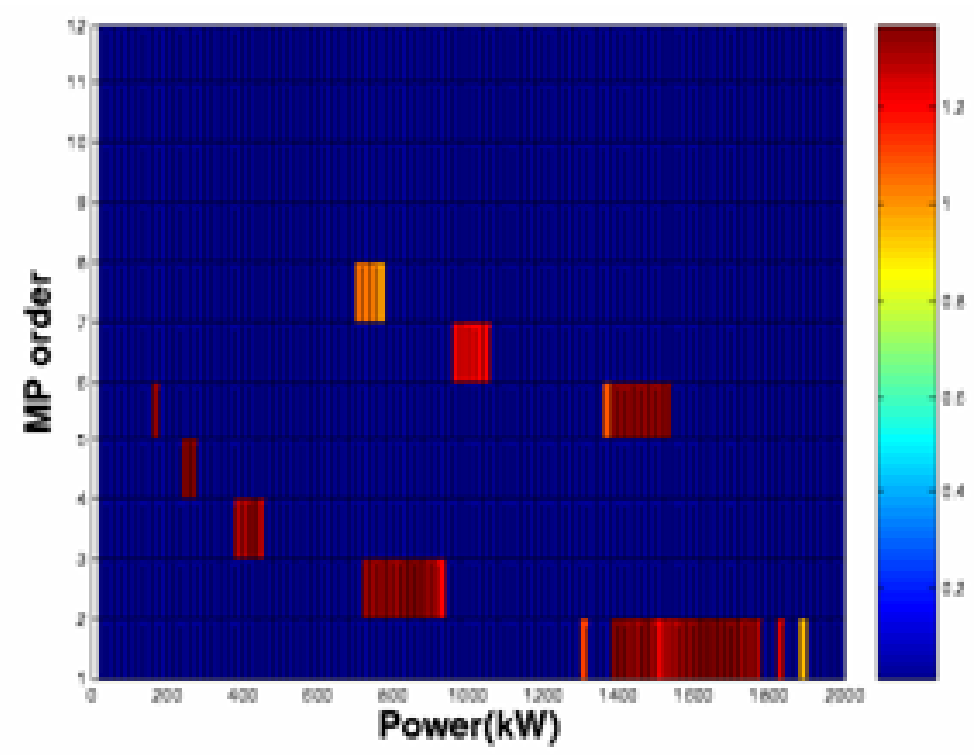

Delta as a function of RF input power and Multipacting order



Samples of particle's resonant trajectory

Reflection: 0.4

Input power level: 160KW

Order: 5th order

Impact Energy region: 542-544 eV

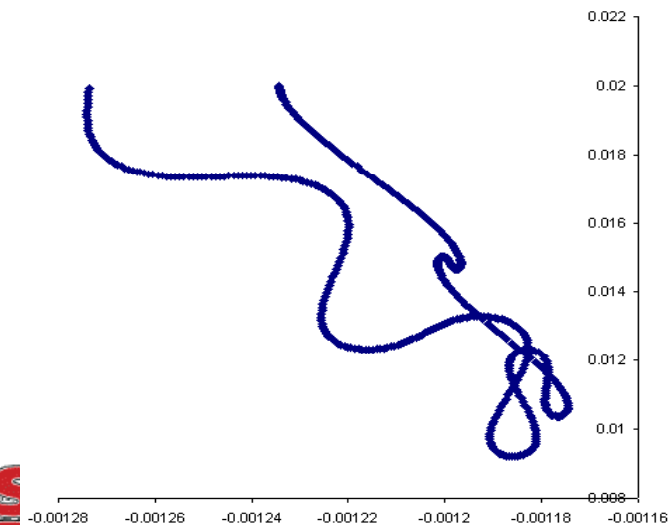
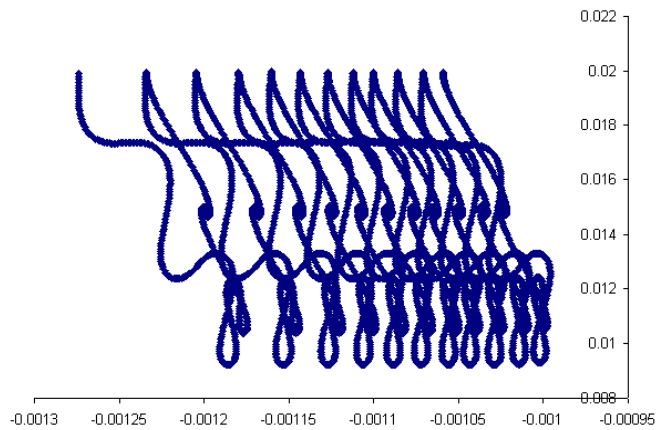

Reflection: 0.8

Input power level: 580KW

Order: 2nd order

Impact Energy region: 1100-1200 eV

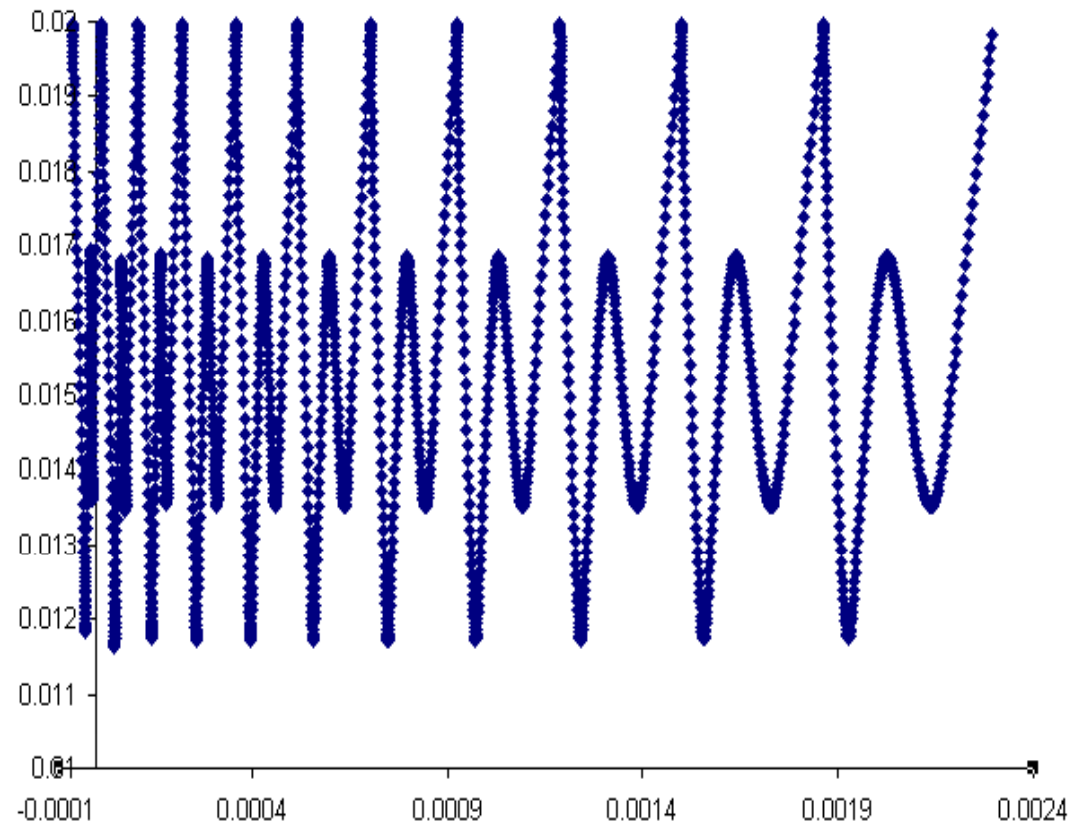

Cold Coax with Bellows

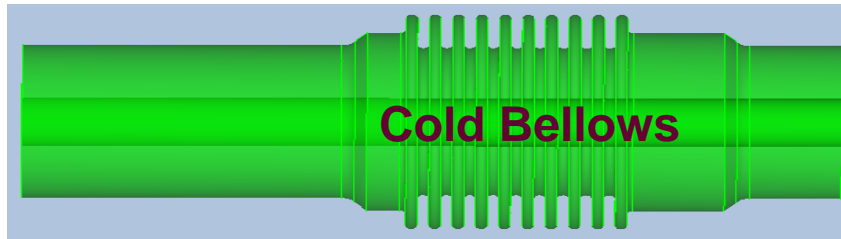

Model

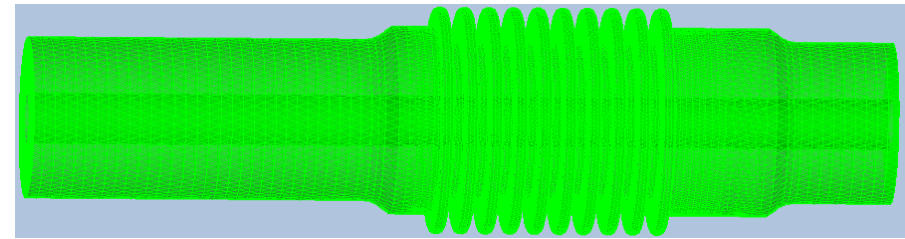

Mesh

NO multipacting activities in the bellows region

Particles Distribution at 2nd Period

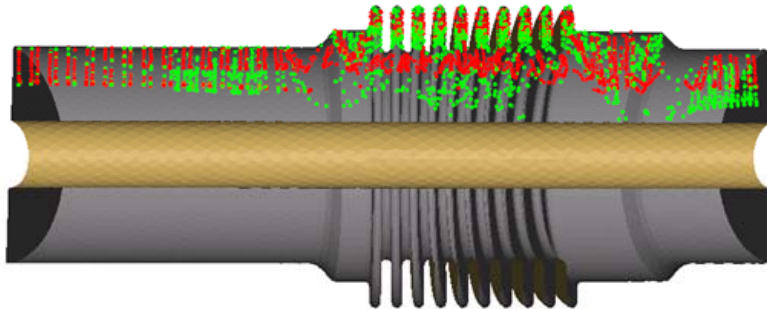

Particles Distribution at 100th Period

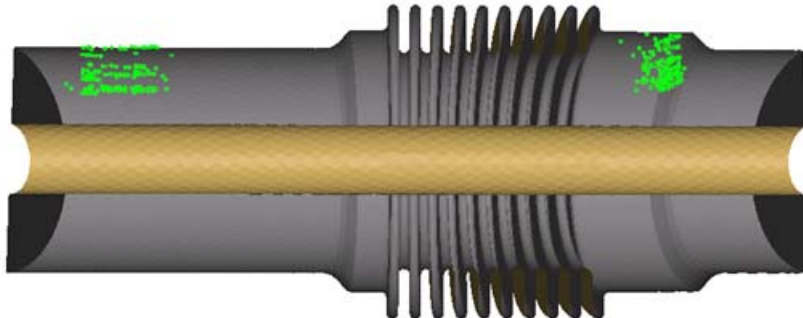

Particles Distribution after 20 impacts

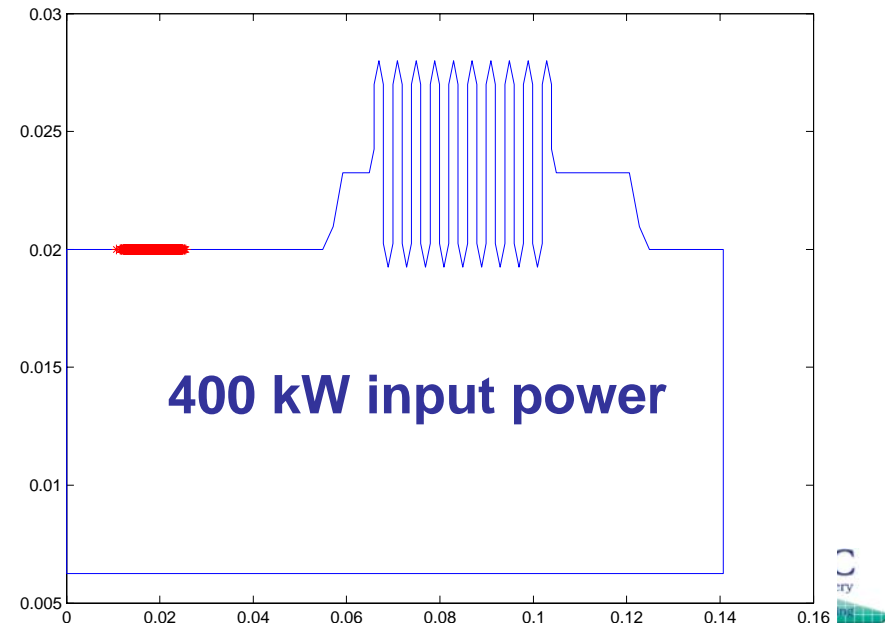

Ceramic Window Region

Model and mesh

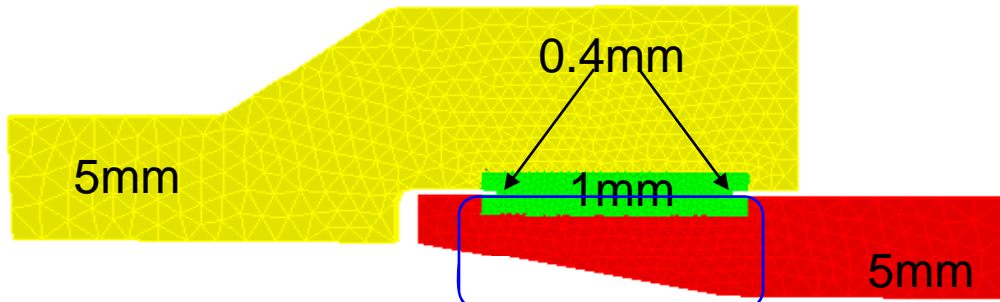

Mesh: mesh.ncdf

Field

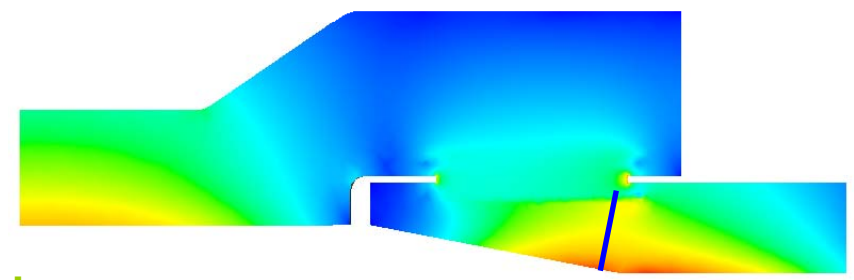

Distribution of two points resonant particles' impact energies, orders versus Input Power between the ceramic window and cold cavity

One resonant particle's trajectory at 0.68 MW input power

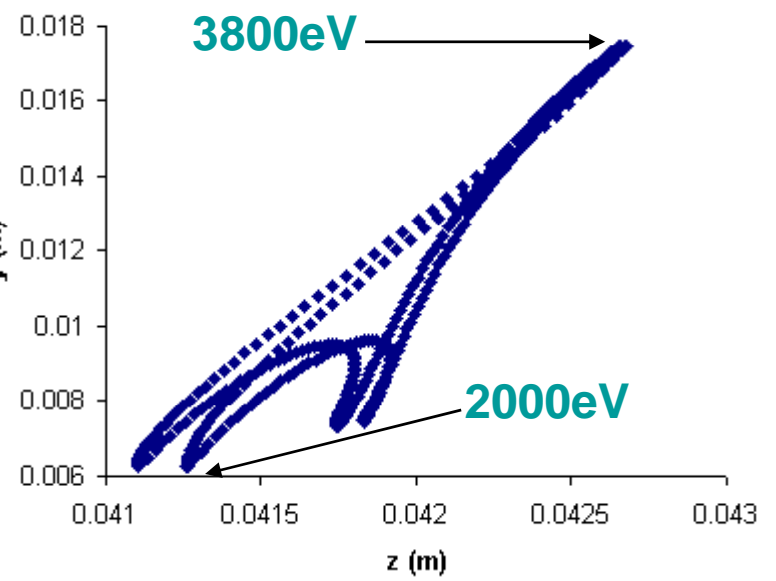
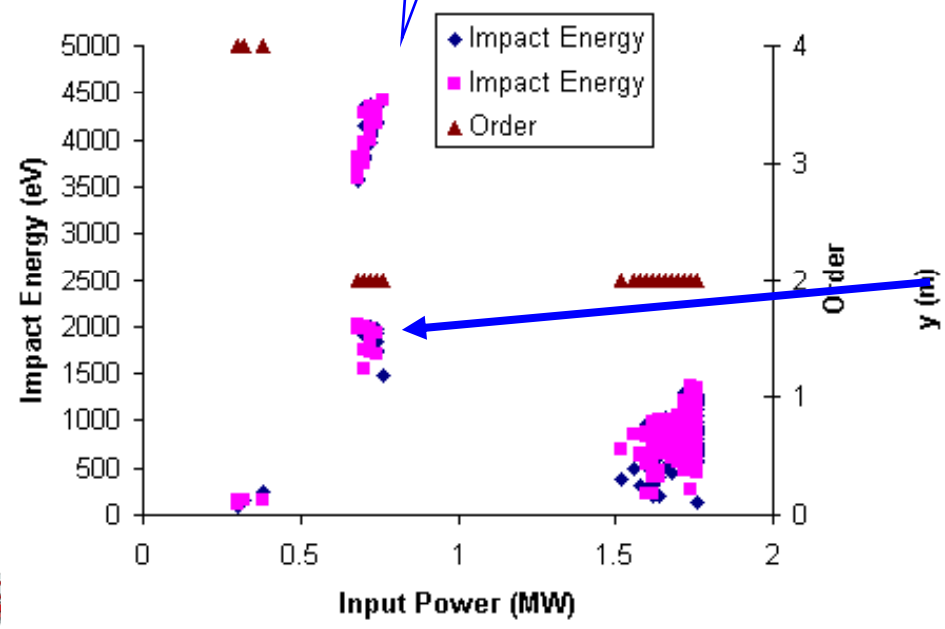

MP simulations on SNS coupler



Model

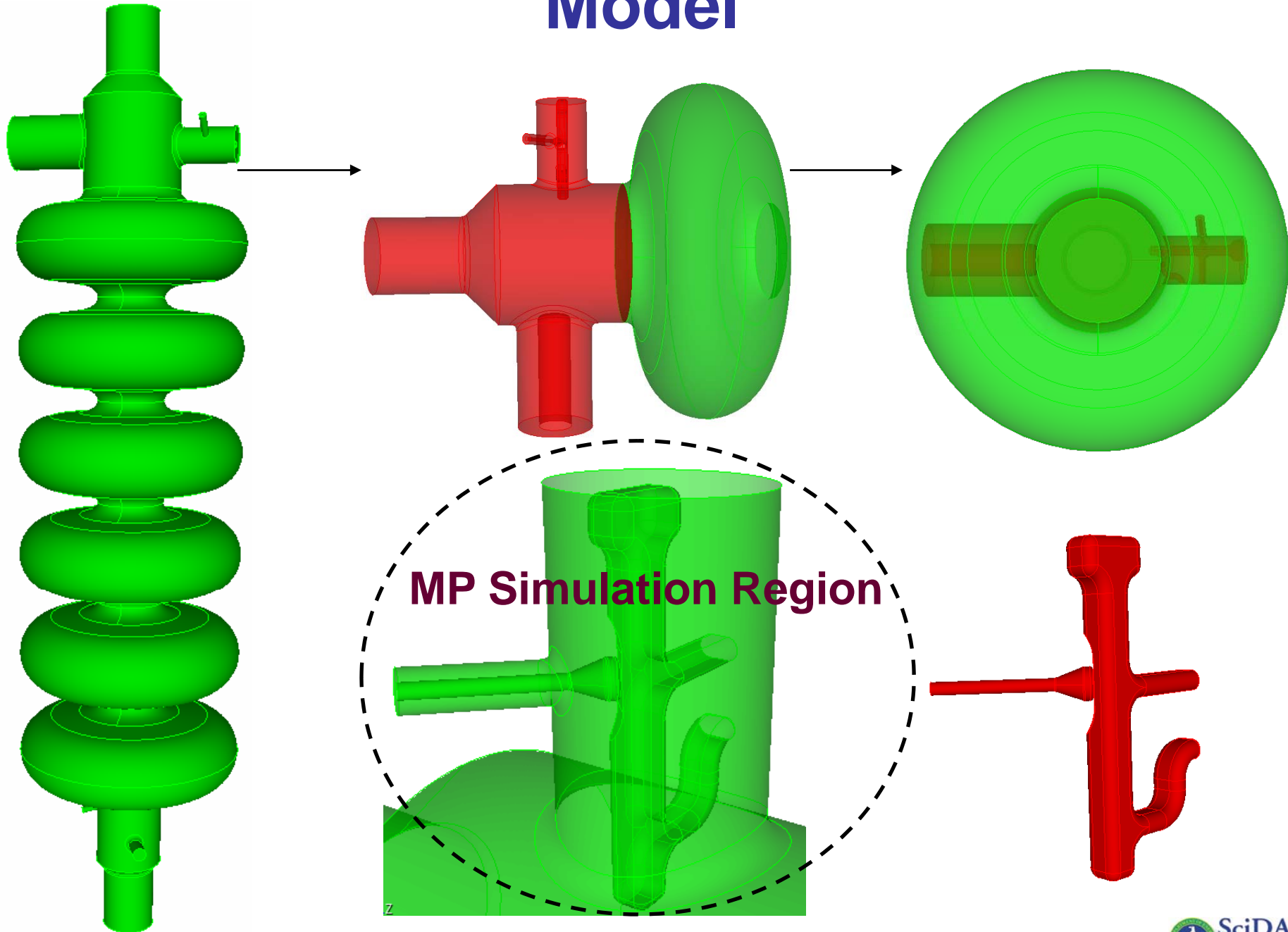

Impact Energy vs. Field Level

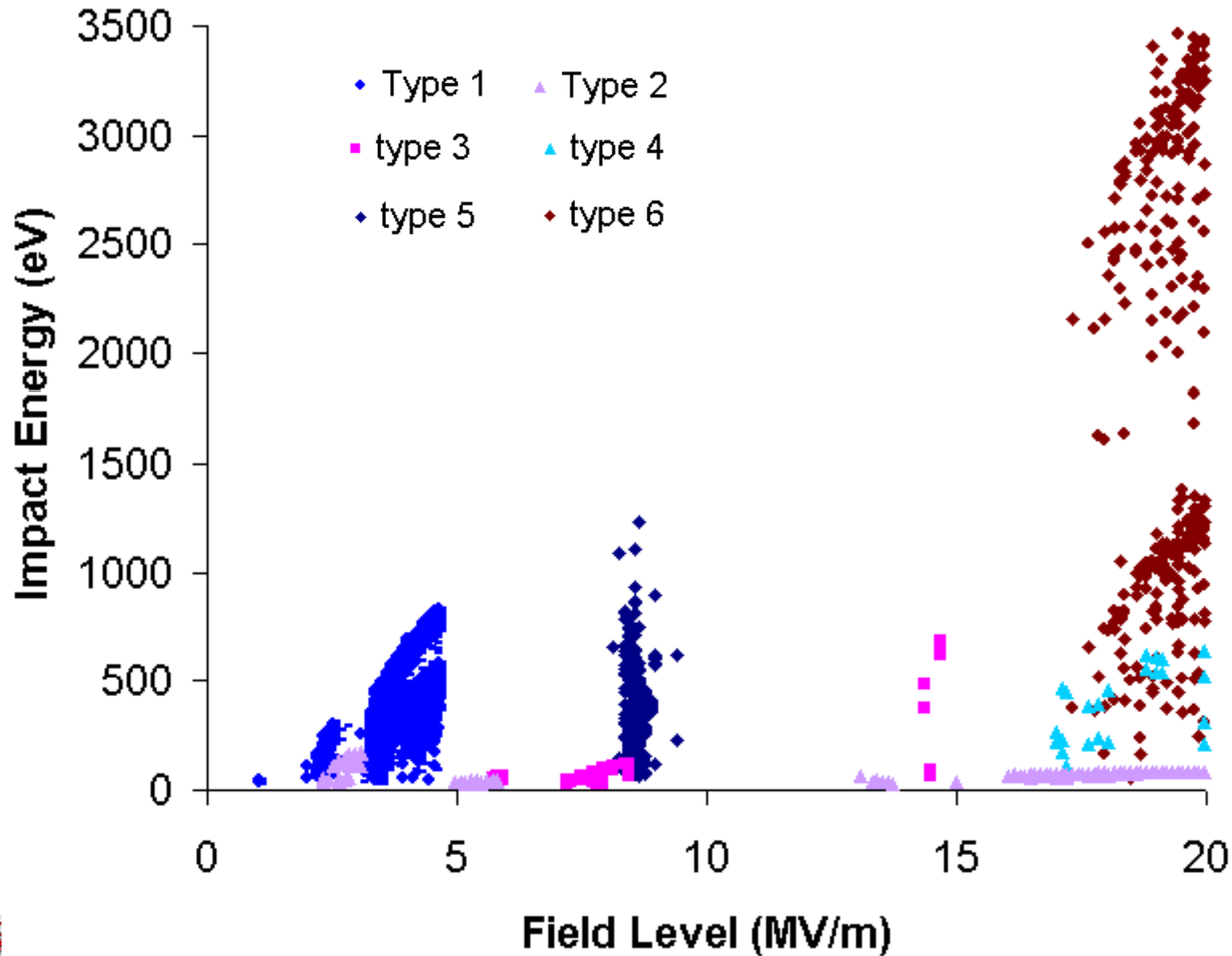

Type1

Impact Energy and Impact Order vs. field level for particles with resonant trajectories

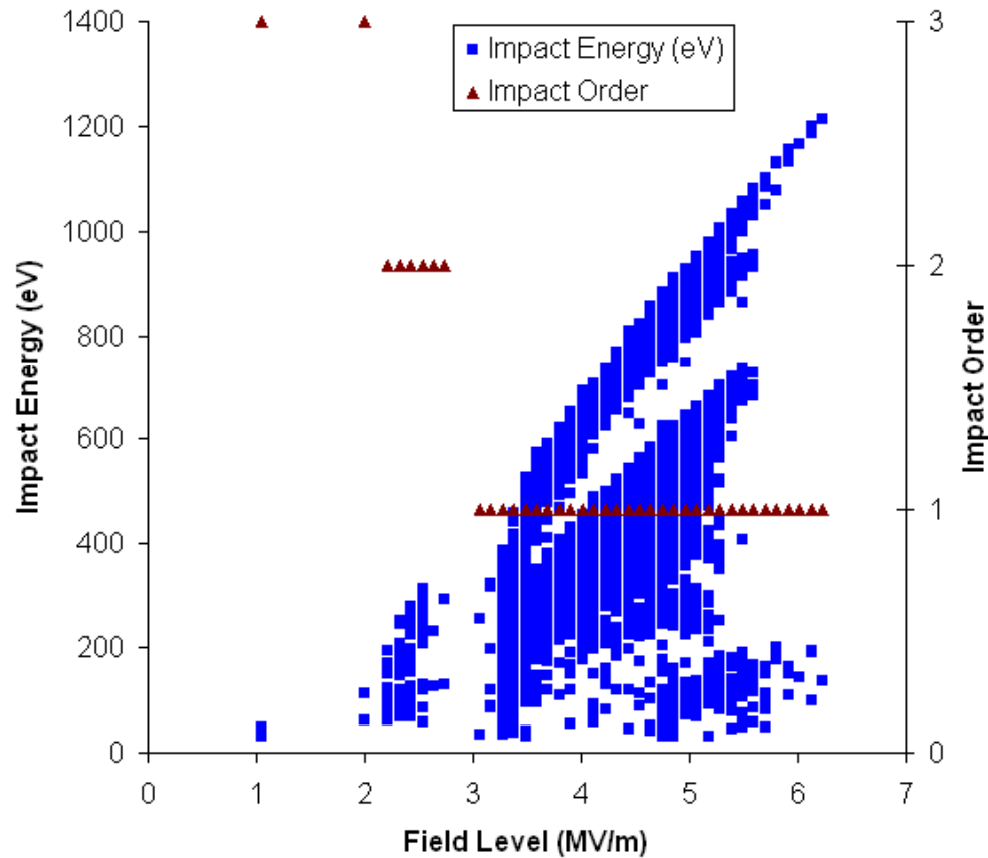

Position for the particles with resonant trajectories

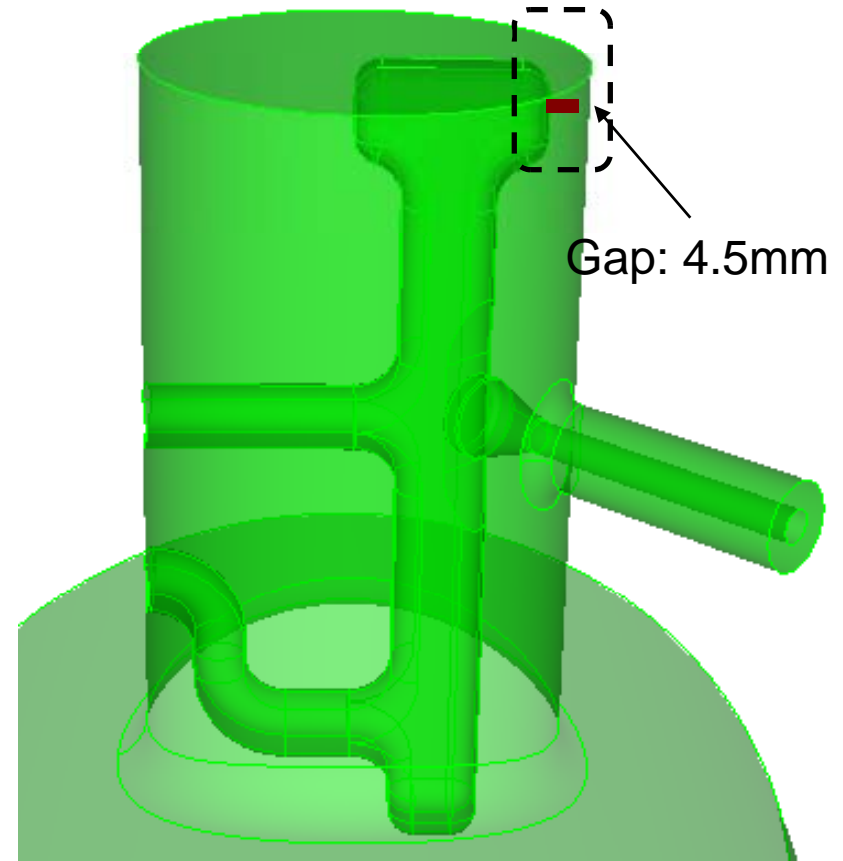

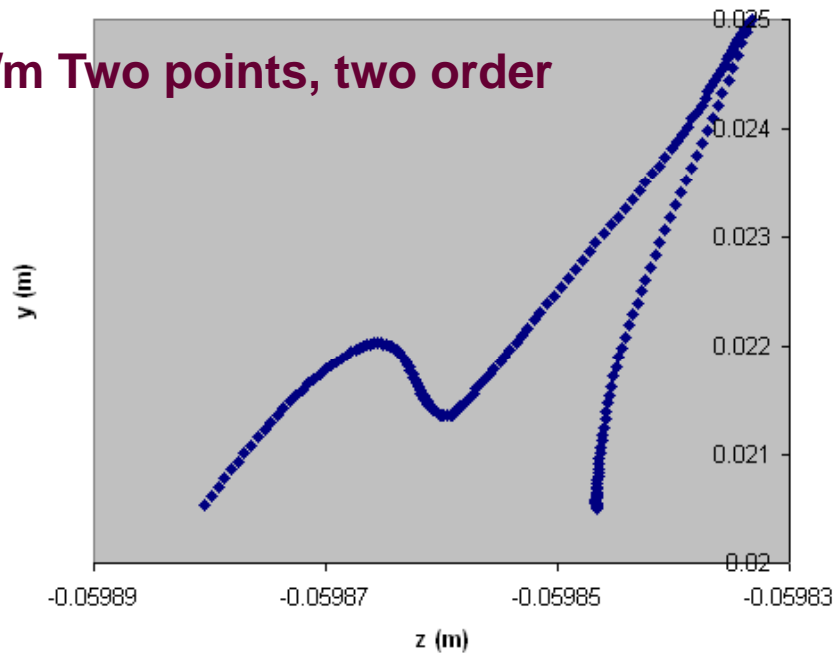
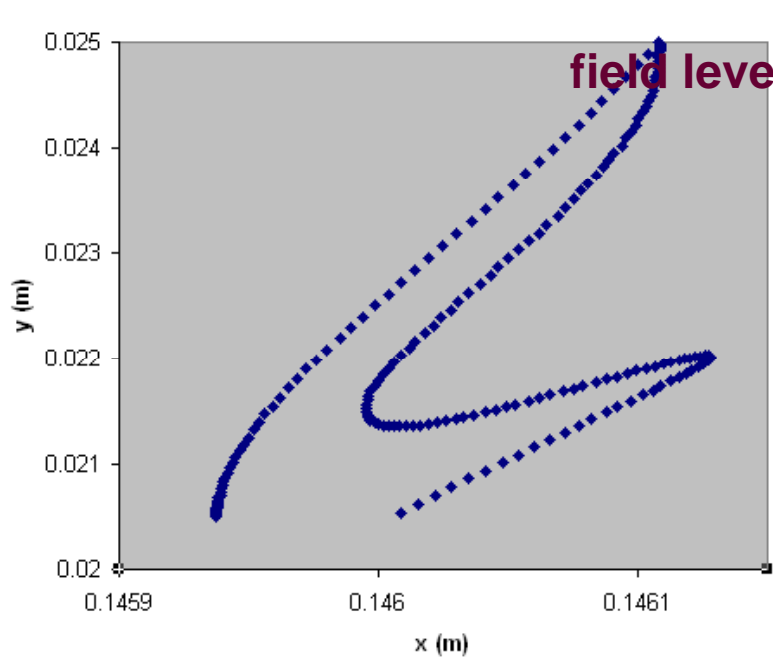

field level 4.22MV/m Two points, one order

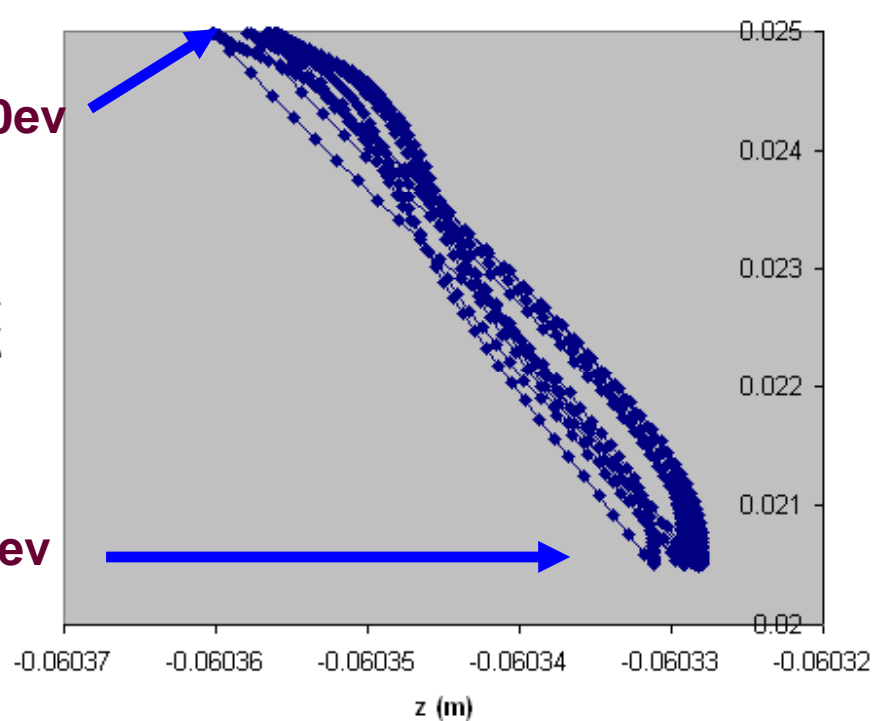
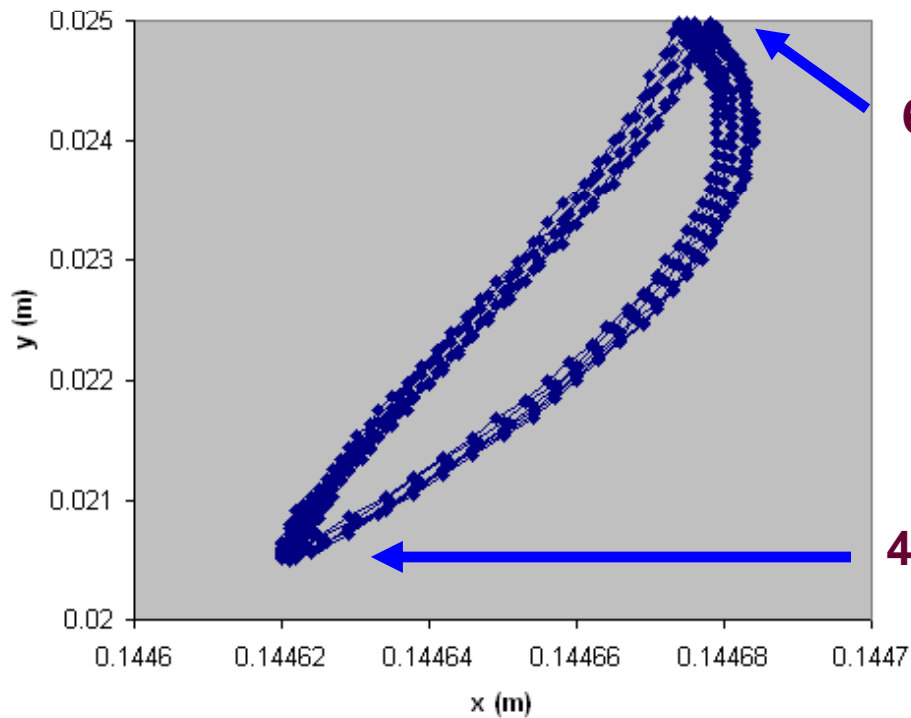

Movie

- **Field Level: 4.11MV/m**
- **Location:**
- **Impact Energy:**
 - Inner: 490 eV
 - Outer: 650 eV
- **MP type: Two points one order**

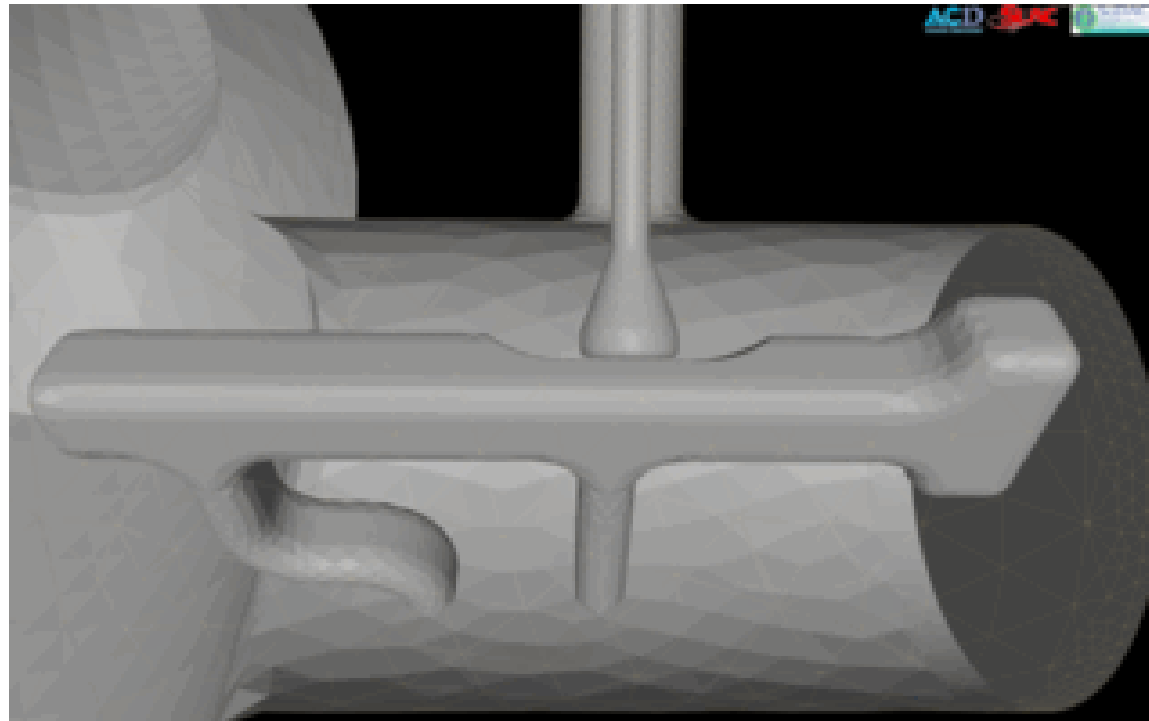
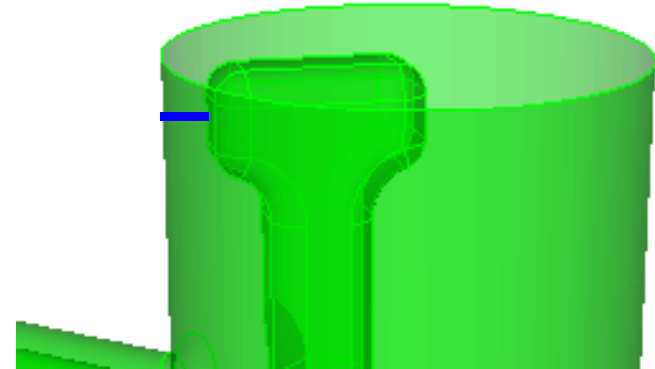

Type 2

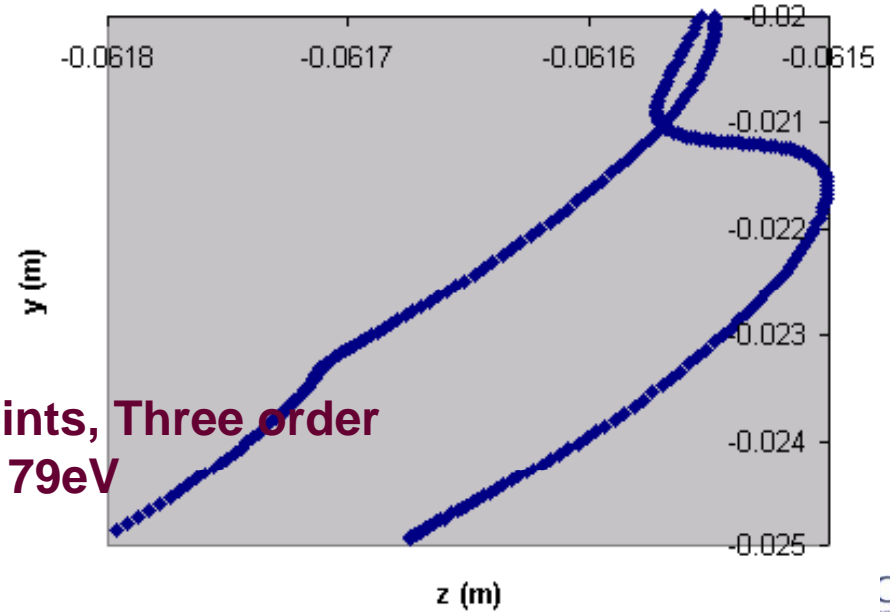
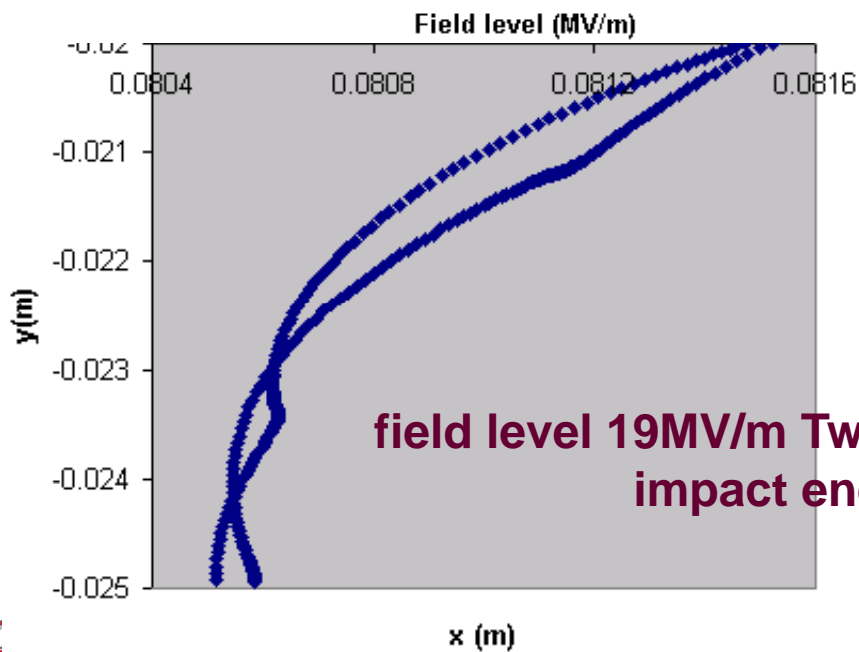
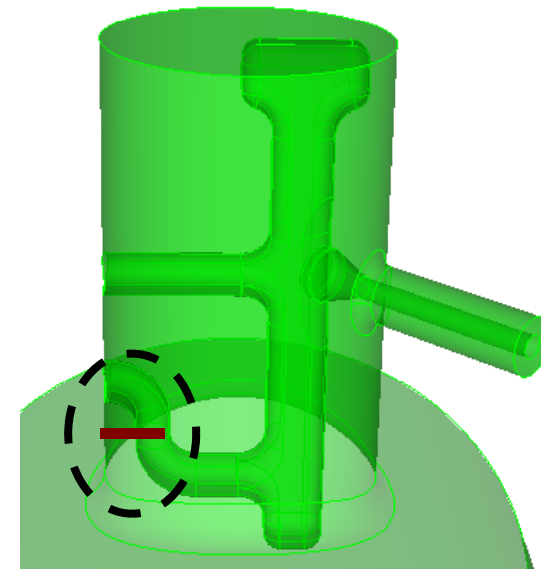
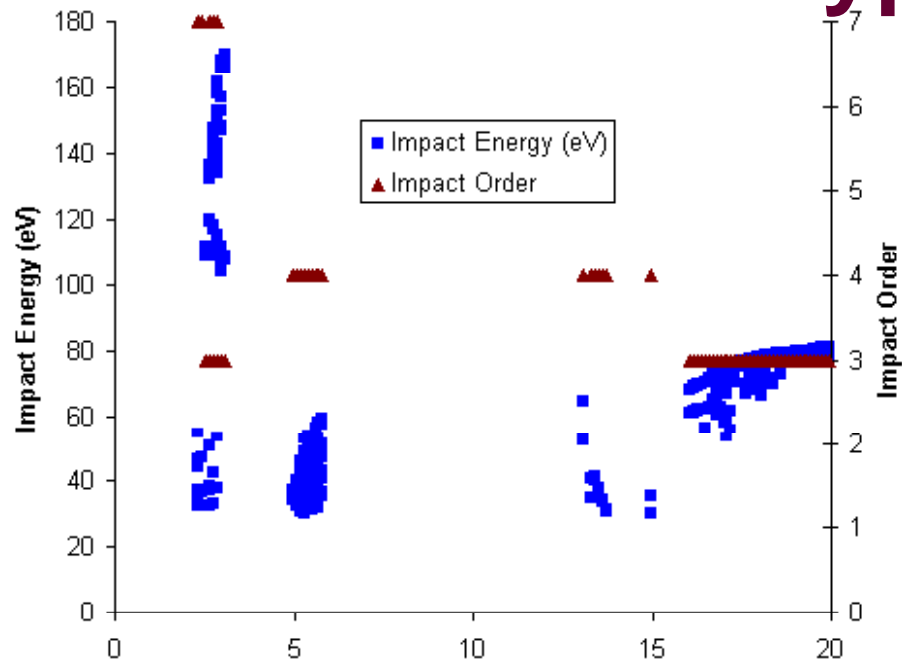

Type3

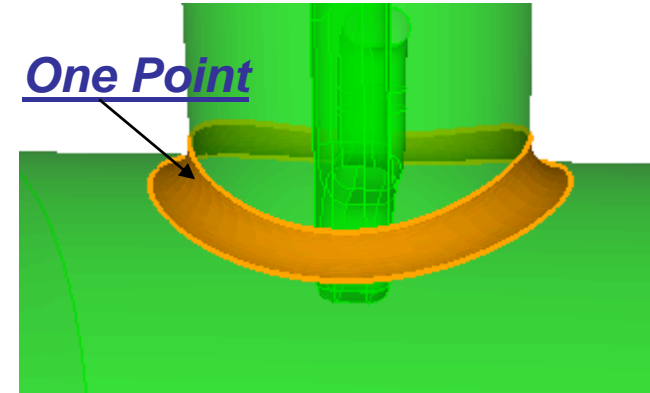
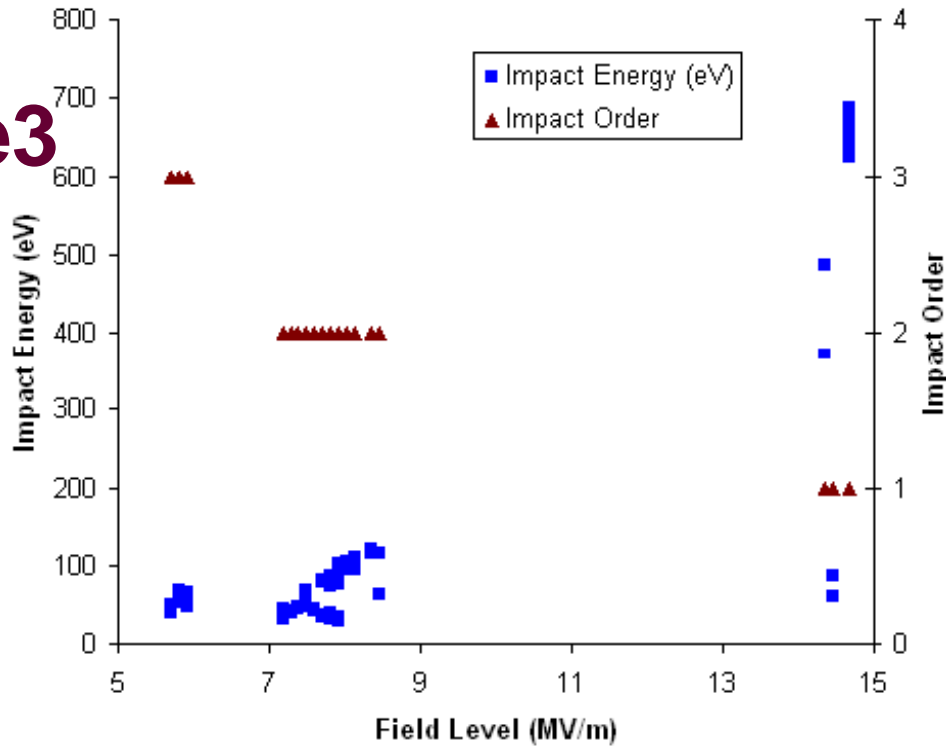

Type4

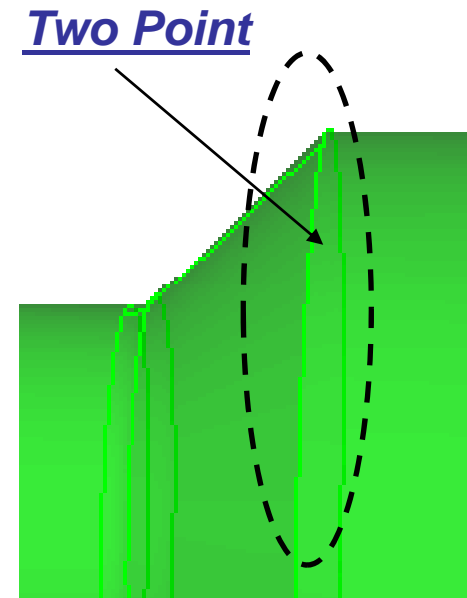
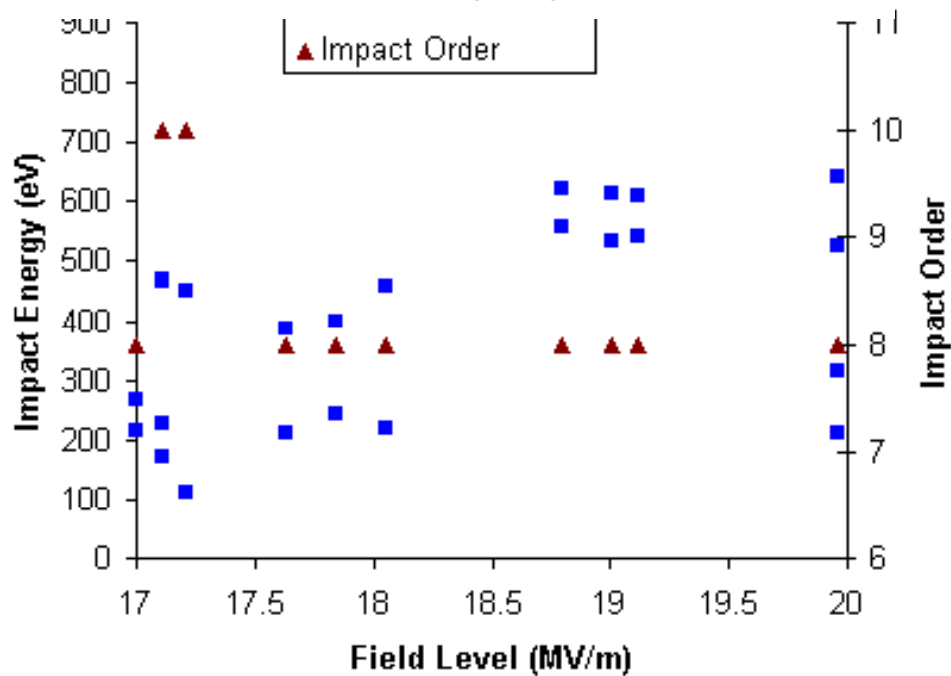

Type 5

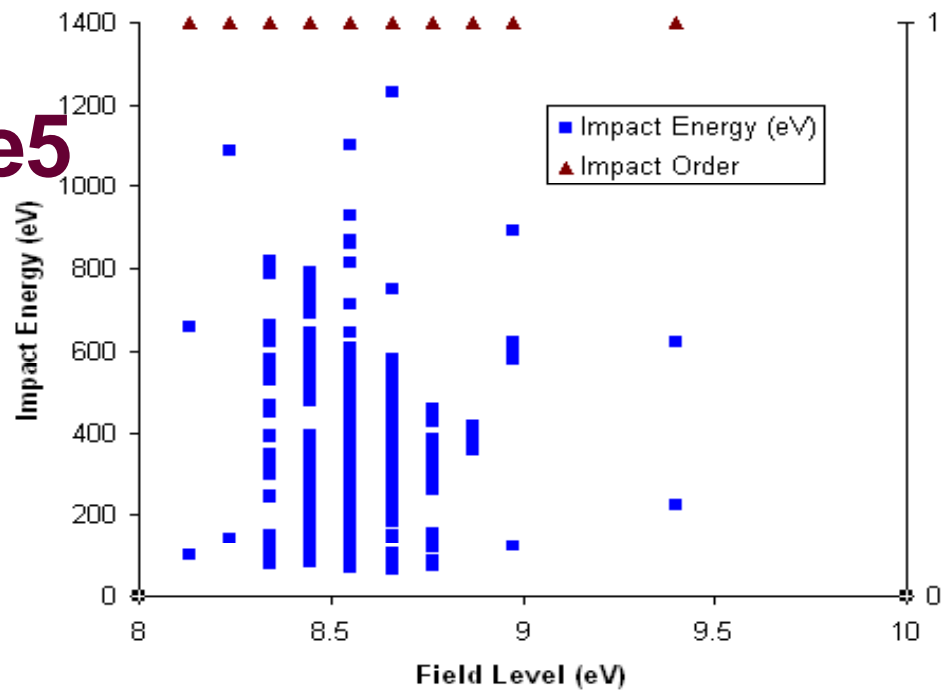

One Point

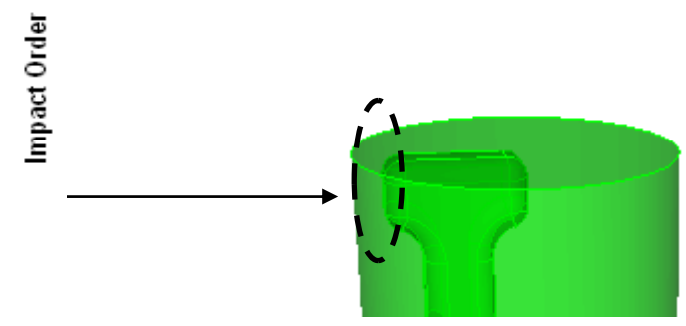

Type 6

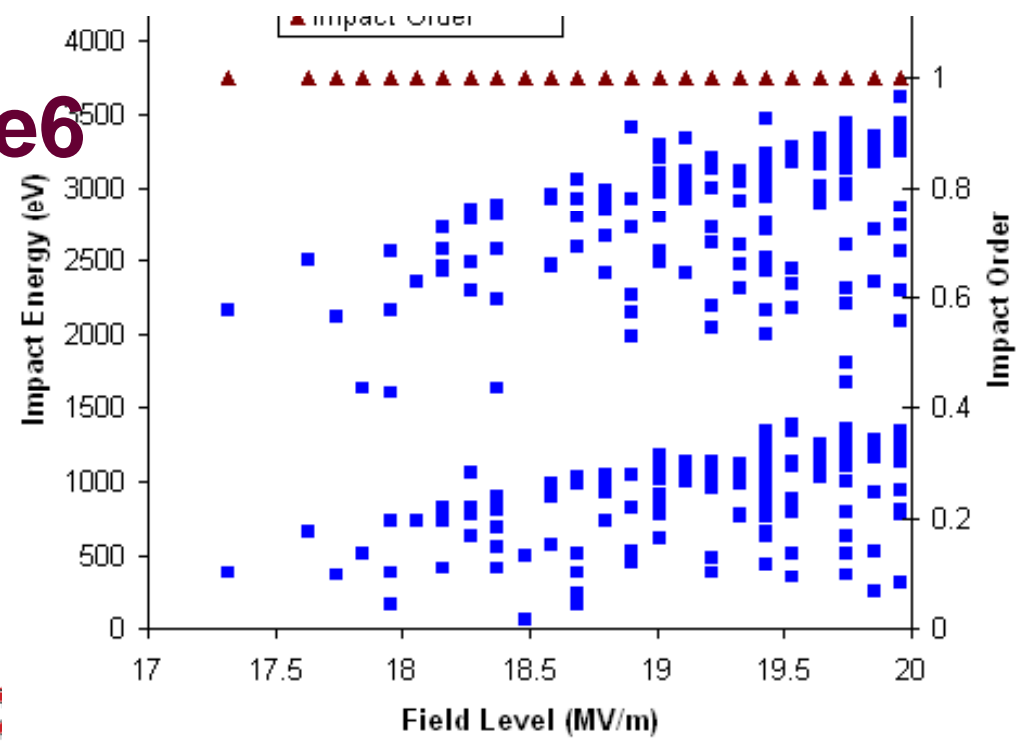

Two Point

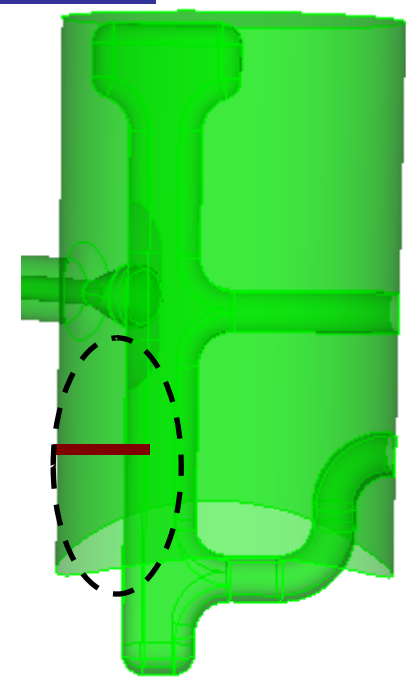

Summary

- **Code development:**
 - 3D parallel high resolution EM code
 - 3D high-fidelity Tracking code
- **Benchmarked with theories and experiments**
- **Applied in different kinds of cavities and couplers, helped for the improvement of cavity design**

