

Design status 2 mrad IR

Current plan for finalization in 2008

Philip Bambade
LAL-Orsay

Recent contributors:

D.Angal-Kalinin, R.Appleby, F.Jackson, D.Toprek (Cockcroft)

P.B., S.Cavalier, O.Dadoun, M.Lacroix, F. Touze, G. Le Meur (LAL-Orsay)

Y. Iwashita (Kyoto)

Joint MDI / BDS session, TILC08 (Japan)

March 5, 2008

Outline

- Motivations
- Status of “minimal” redesign
- Current plans and aims
- Concluding remarks

.....

Alternative IP luminometry & polarimetry idea ?

Motivations for 2 mrad

- Large crossing-angle :
 1. Eases post-IP beam extraction & transport → diagnostics
 2. But adds pre-IP constraints : crab-cavity control & tuning, non-axial solenoid + DID / anti-DID → pre / post-IP trajectory bumps
 - Physics & detector advantaged by small crossing-angle IR : simpler forward geometries, better hermeticity, no DID / anti-DID
 - Head-on IR a priori nicest → needs large electrostatic separators
 - **2 mrad scheme** : no crab-cavity (initially...), no electrostatic separators and order-of-magnitude smaller pre / post-IP trajectory bumps
 - Snowmass 2 mrad design **unsatisfactory** → redesign with simpler concept aiming to be as short & economical as possible
 - **Assumption** : other ways than the present spent-beam spectrometry & polarimetry possible if planned pre-IP measurements need complementing
- **Minimise costs and mitigate technical risks**

New “minimal” extraction line concept

→ Explicit goals : short & economical, as few and feasible magnets as possible, more tolerant and flexible

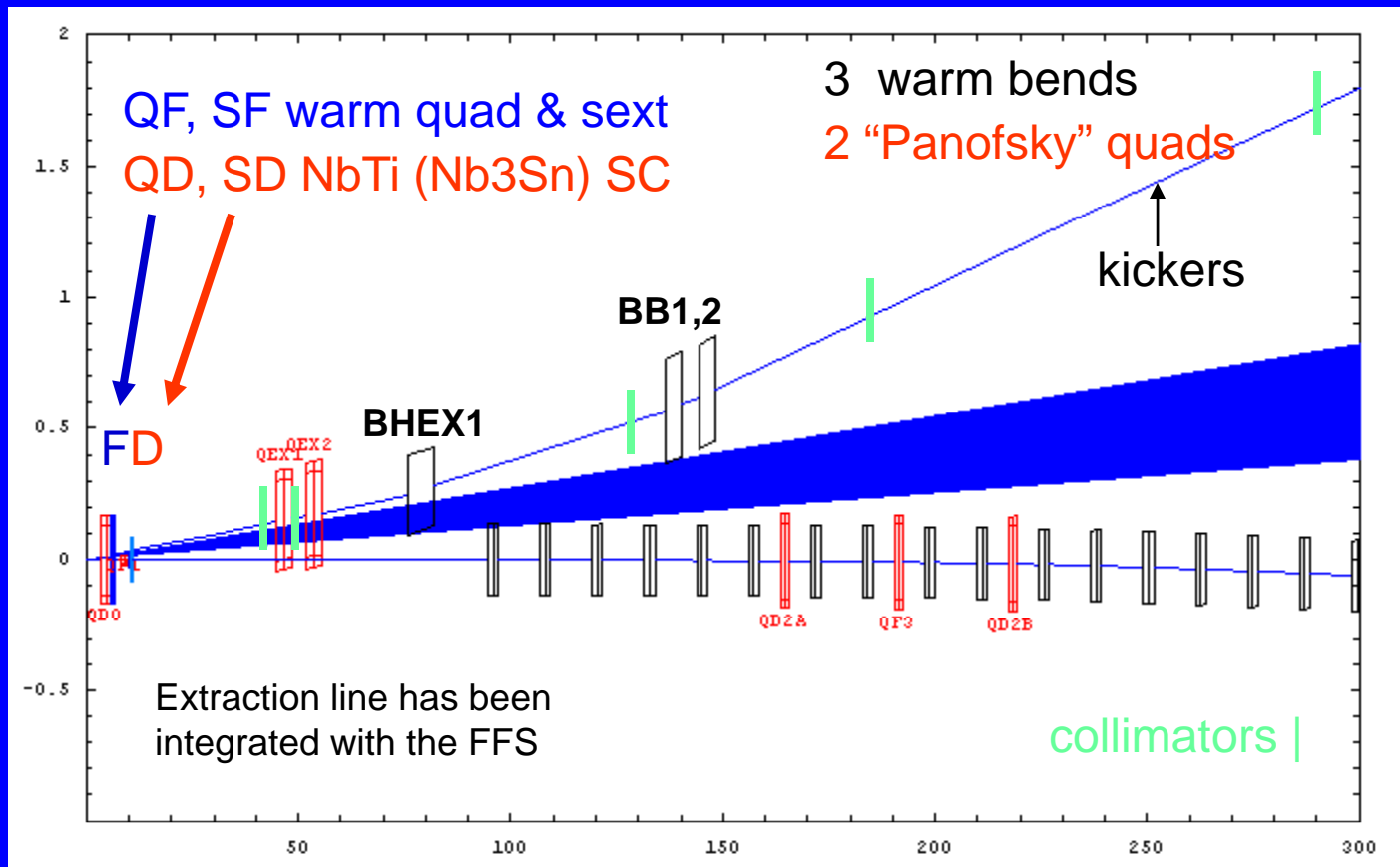

Length ~ 300 m

Beam rastering kickers can be placed to prevent water boiling and window damage

Optimised compact final doublets

- Re-designed with acceptable losses and stay-clear for in / out charged & beamstrahlung beams → [EUROTeV-Memo-2007-001 & JINST 1 P10005 \(2006\)](#)
- Works for all proposed ILC beam parameter sets, including (new) “High Luminosity” at 1 TeV (GP++ large statistics at <http://ilc-mdi.lal.in2p3.fr/spip.php?rubrique17>)
- Compact SC QD,SD : NbTi LHC-like QD at 500 GeV, Nb3Sn SLHC-like QD at 1 TeV, NbTi 60 mm radius SD
- Standard warm QF & SF, with 20 and 30 mm radius
- Outgoing beam subject to non-linear pocket fields of QF1 and SF1

Table 1: The 500 GeV final doublet parameters.

Parameter	QD0	SD0	QF1	SF1
Length [m]	1.059	1.469	1.596	0.75
Strength	-0.270 m^{-2}	2.969 m^{-3}	0.0786 m^{-2}	-2.044 m^{-3}
radial aperture [mm]	28	60	20	30
gradient [T/m]	225	-	65	-

Table 4: The 1 TeV final doublet parameters.

Parameter	QD0	SD0	QF1	SF1
Length [m]	1.352	2.5	3.192	1.5
Strength	-0.210 m^{-2}	1.502 m^{-3}	0.0394 m^{-2}	-0.943 m^{-3}
radial aperture [mm]	25	59	20	30
gradient [T/m]	350	-	66	-

Parameter set	QD0	SD0
High Luminosity CB [W] 500 GeV	<1	<1
High Luminosity RB [W] 500 GeV	0.46	0.2
High Luminosity CB [W] 1 TeV	<1	<1
High Luminosity RB [W] 1 TeV	0.82	0.04

Losses in SC magnets [W]

	500 GeV	1 TeV
l^* [m]	4.5	4.5
QD0-SD0 [m]	0.8	0.8
SD0-QF1 [m]	3.03	2.05
QF1-SF1 [m]	0.5	0.5

Magnets and collimators in rest of line

- Designed proof-of-principle optics with reasonable QEX1,2, BHEX1 and BB1,2 apertures & strengths and acceptable losses on dedicated collimators at both 500 GeV and 1 TeV → [EUROTeV-Memo-2007-004](#), [EUROTeV-Memo-2007-005](#)
- Can be adjusted depending on best choice of dump arrangement
- Flexibility : magnet + beam pipe designs → final parameters

Magnet	Length	Strength/angle	Radial aperture [mm]	B [T]
QEX1	3.0	0.011 /m	116	1.04
QEX2	3.0	0.0056 /m	138	0.63
BHEX1	8.0	2.0 mrad	-	0.21
BB1	8.0	2.0 mrad	-	0.21
BB2	8.0	2.0 mrad	-	0.21

worst case maximum : high luminosity parameters with vertical offset

Collimator name	Position [m]	Length	Power load [kW]	X jaw [mm]	Material	Cooling
QEX1COLL	38.75	1.0	15	104	Cu	Radiative
QEX2COLL	45.75	1.0	15	95	Cu	Radiative
COLL1	150	2.5	205	116	Al (balls)	Active
COLL2	200	2.5	205	204	Al (balls)	Active

BHEX1 C-type bend

Accommodates the beamstrahlung, outgoing beam and proximity of incoming beam

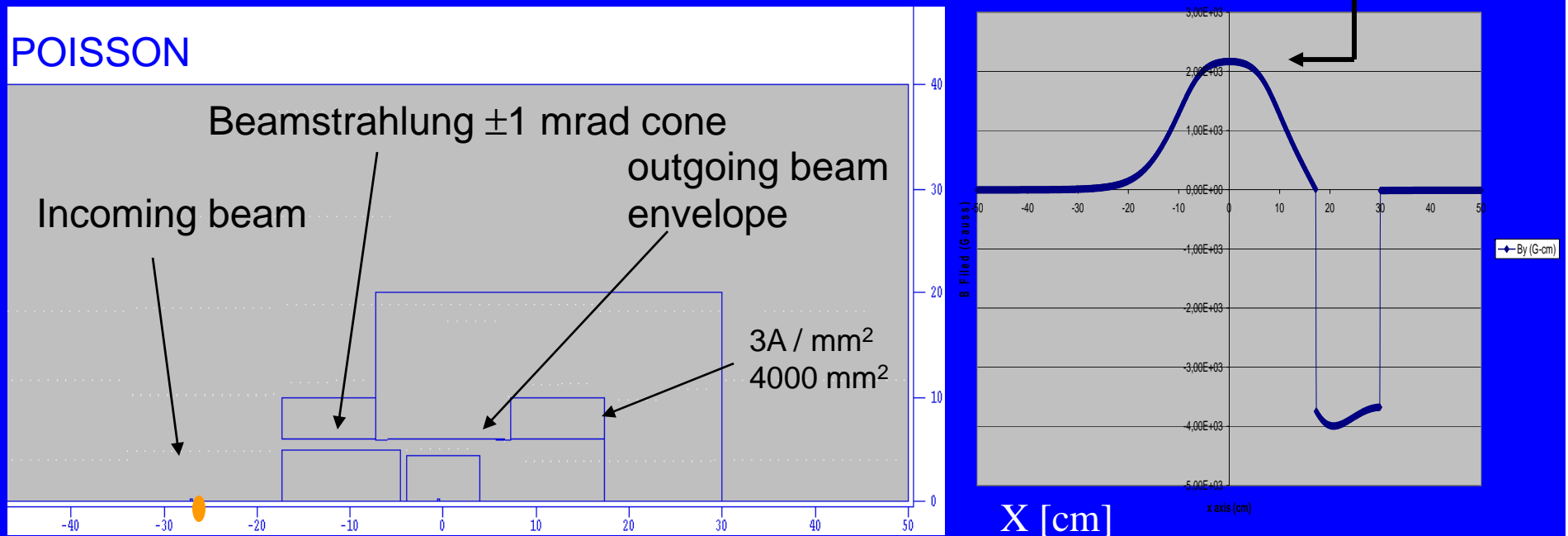

- $B_y(x)$ homogeneity $< 4 \%$ (with shims) within outgoing beam envelope \rightarrow checked to be sufficient
- Residual B_y on incoming beam $\sim 1\% \rightarrow 20 \mu\text{rad}$ ($7.5 \sigma_{x'}$) \rightarrow use corrector
- Residual $B_x(y)$ dependence on incoming beam \rightarrow only even powers sextupole absorbed refitting SD / SF, decapole \rightarrow negligible effects

Bandwidth from BEX1 decapole component

Comparison done with ILC final focus optics integrating FD of 2 mrad scheme

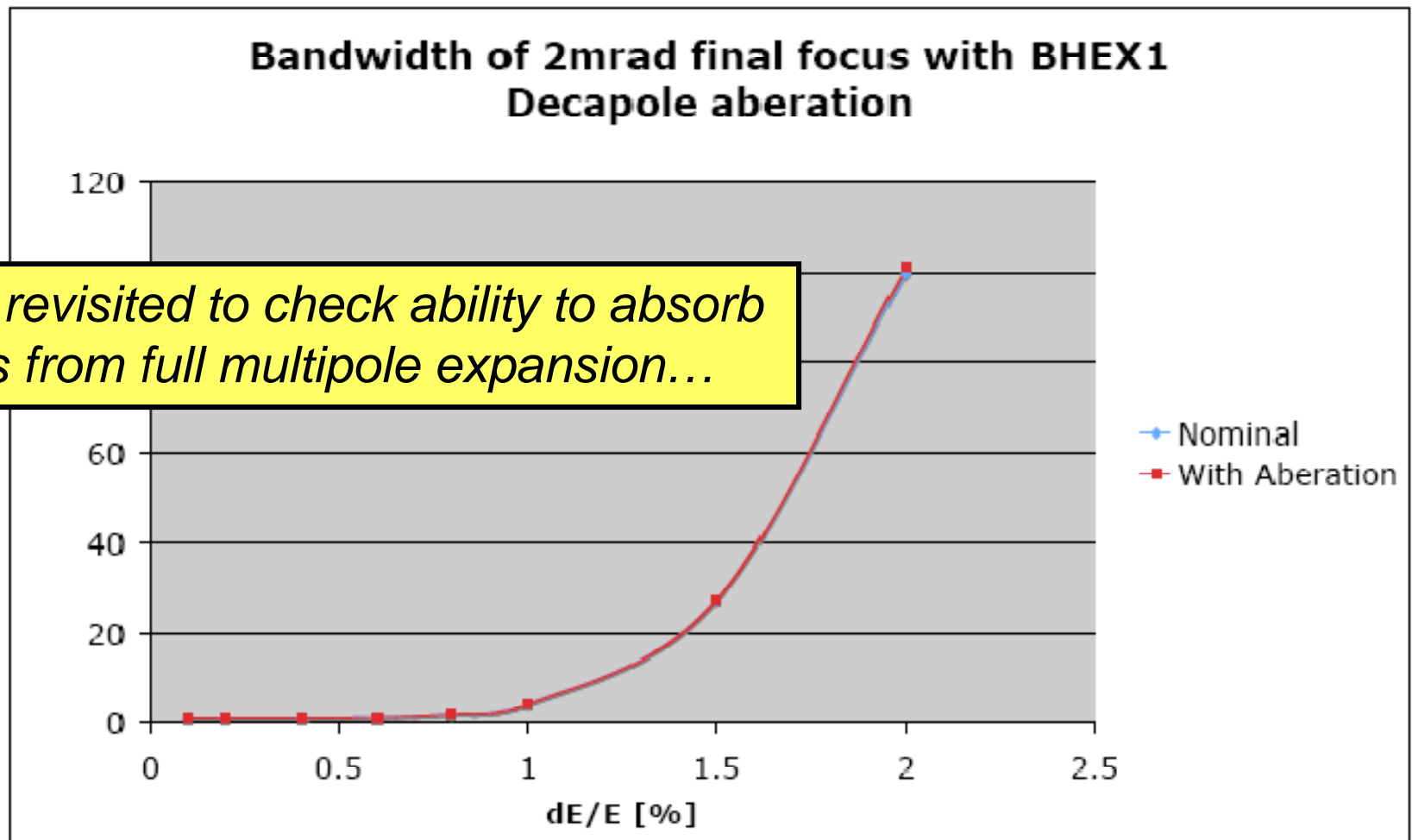

QEX1 modified “Panofsky”-style quad design

Permanent magnet plates help reduce field to 10 Gauss for incoming beam

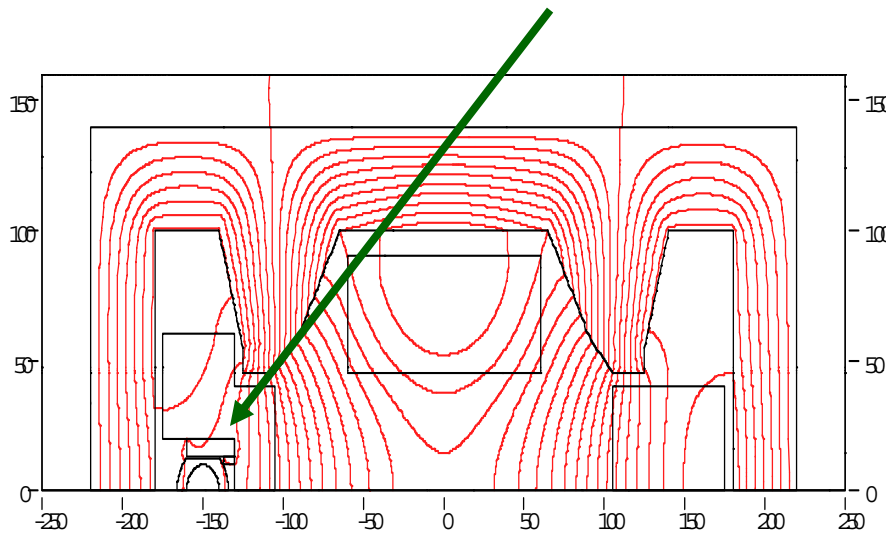

Multipole expansion

$$(B_x - iB_y) = \left[\sum_n n(A_n + iB_n)/r * (z/r)^{n-1} \right]$$

n	n(A _n)/r	n(B _n)/r	Abs(n(C _n)/r)
1	-1.8355E+00	00000E+00	1.8355 E-00
2	-4.0798E+03	00000E+00	4.0798 E-03
3	-2.6446E+00	00000E+00	2.6446 E-00
4	-6.4440E+01	00000E+00	6.4440 E-01
5	-1.1749E+00	00000E+00	1.1749 E-00
6	2.1582E+01	00000E+00	2.1582 E-01
7	-3.4437E-01	00000E+00	3.4437 E-01
8	-1.8381E+00	00000E+00	1.8381 E-00
9	-7.6307E-02	00000E+00	7.6307 E-02
10	-2.0240E+00	00000E+00	2.0240 E-00

QEX1

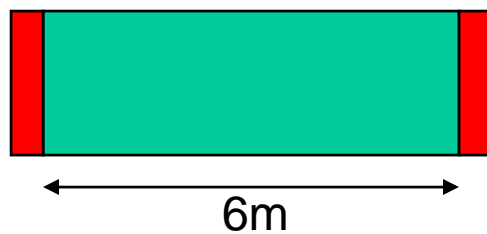

Extra multipole field components modeled in DIMAD

Lumped multipole errors

- Disrupted beam tracking (500 GeV) along the extraction line with multipoles:
 - Power loss increase of 1kW at 1 collimator
 - Dump beam size increase of 5%

EDR plans

Aim of proposed EDR-phase 2 mrad tasks is to bring the design to the level of a credible alternative to the 14mrad baseline

- **Optics and beam transport**
 - variable I* IR and extraction line layout (CI)
 - further study of extraction line aberrations on final focus beam(CI, LAL)
 - iteration of design and losses as magnet designs progress (LAL, CI)
 - iteration of integration of 2 mrad FD in final focus optics (CI)
- **Magnet design studies**
 - design of large aperture final horizontal bends BB1 and BB2 (LAL, CI)
 - design of standard warm FD magnets QF1 and SF1 (LAL)
 - design of a modified Panofsky quadrupole magnets (Kyoto university) [feasibility,cost]
 - engineering design of QD0 and SD0 [feasibility for compact SD0 size,cost]
- **Other engineering and integration work**
 - Integration of final doublet into detector, including
 - cryostat design and FD support / services
 - anti-solenoid or skew-quadrupoles for coupling correction, with appropriate integration
 - design of beam pipe in shared area (LAL) [detailed drawings critical]
 - design of beam pipe in extraction line (LAL) [detailed drawings critical]

There is real flexibility in this scheme, with margins and adjustable parameters

Summary and conclusion

- Progress made → credible small angle alternative for IR
- Documented design including magnet and beam pipe assessment  scheduled within 2008
- main current work planned :
 - 1) finish QEX1,2 Panofsky quads
 - 2) design QF and SF to revisit pocket field impact and assess beam pipe shape in shared region
 - 3) Check design of super-conductive SD & QD

Additional slides

2 mrad beampipe layout in IR region

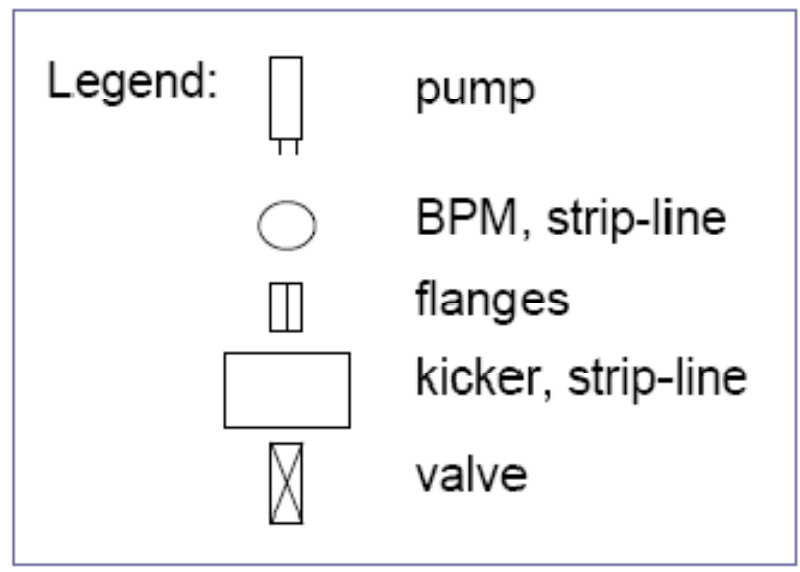
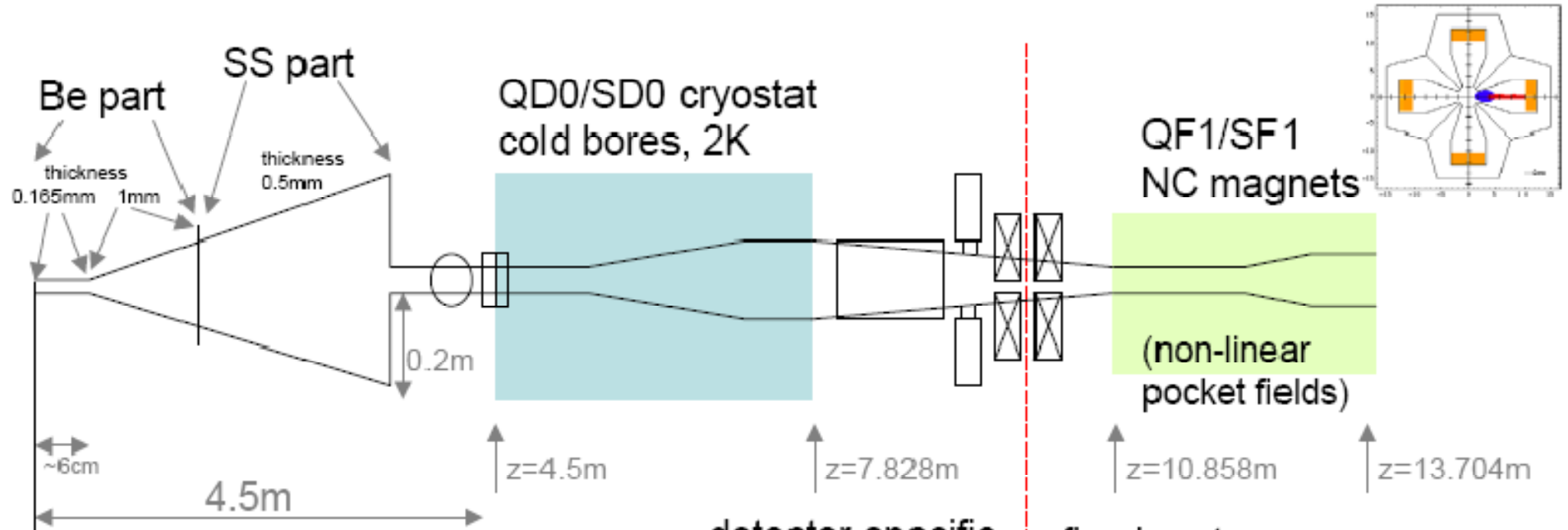

detector-specific part

fixed part

$z \sim 9.5\text{m}$

Tapering apertures between shared beamline elements

Breakpoint between SD0 and QF1

No FD cryostat needed for QF1/SF1

QD0/SD0 outer sizes, cryostat design/size, support for integration and detector opening procedure ?

Adapted from 14mrad drawing by Andrei Seryi

Variable I^* IR layout

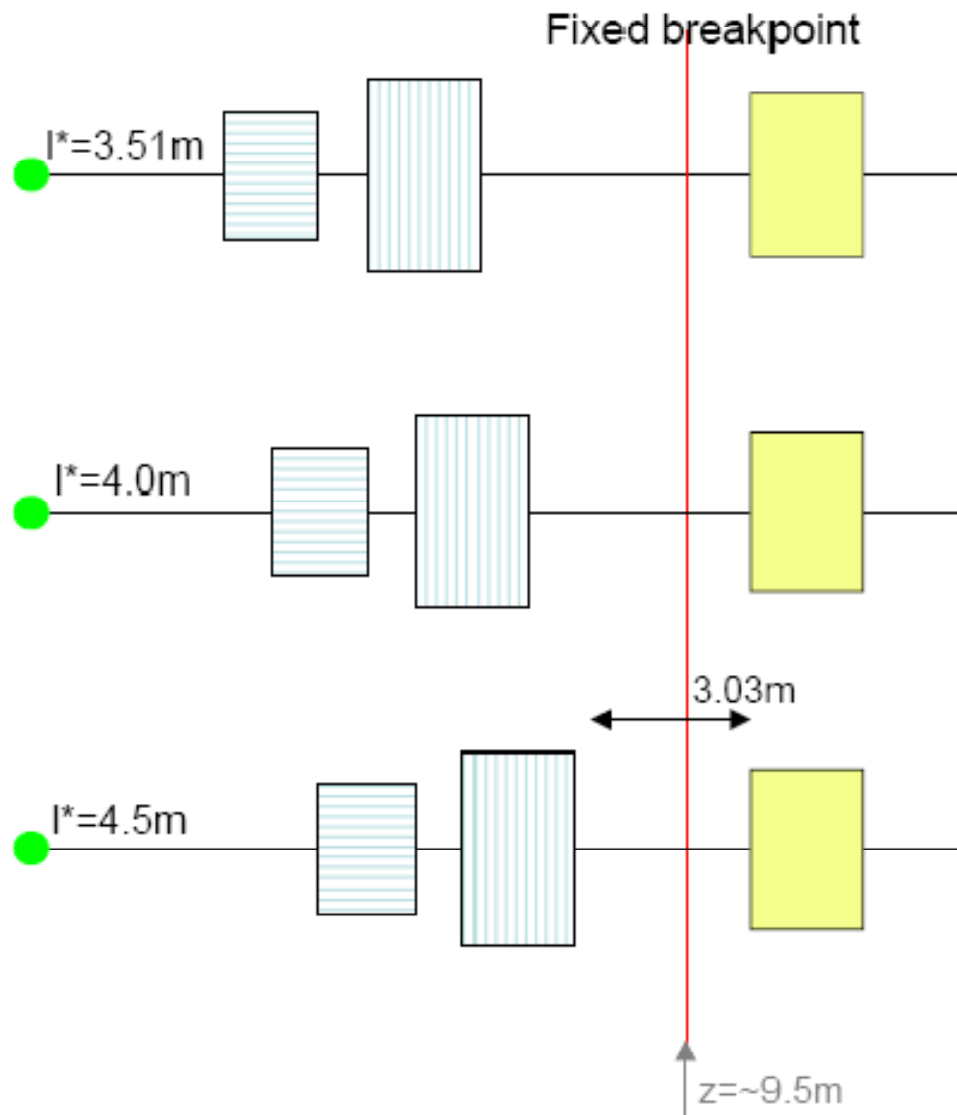

Optics design exist for $I^*=4.5\text{m}$.
Variable I^* achieved by

- Fixed breakpoint located between SD0 and QF1
- Optics refitted by varying SD0-QF1 distance to obtain sufficient beam separation and minimum losses
- Some impact on beam power losses and beam separation

Keep physical size of FD magnet constant (change currents)

Variable I^* of detector gives varying downstream orbit. Correct using corrector dipoles

Key:  QD0  SD0  QF1  IP

First thoughts → needs to be worked out in detail

First look at beam pipe in FD region

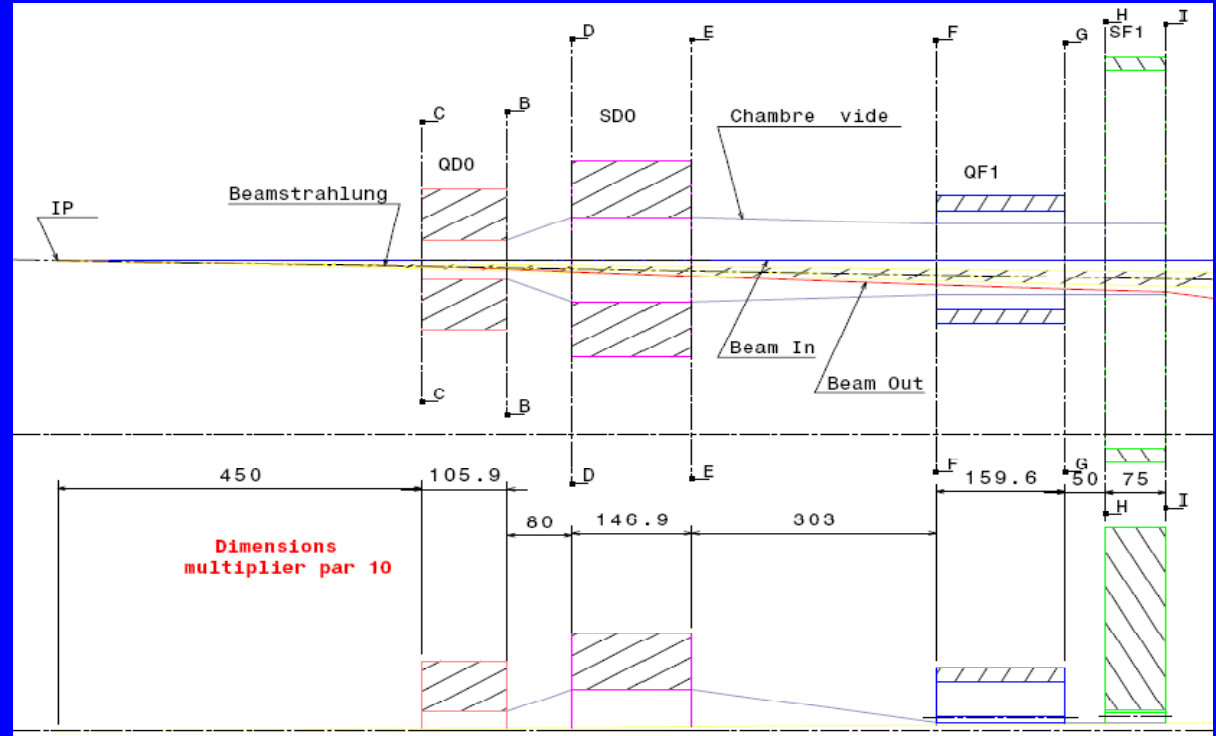
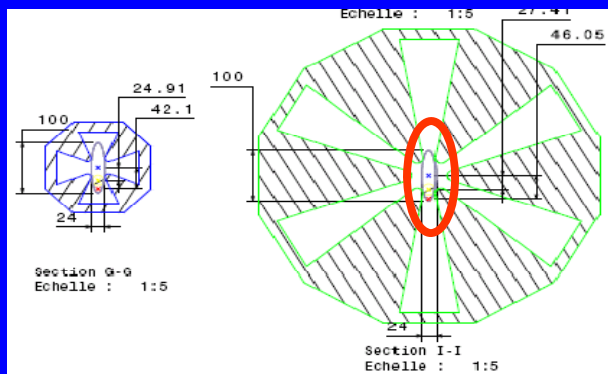
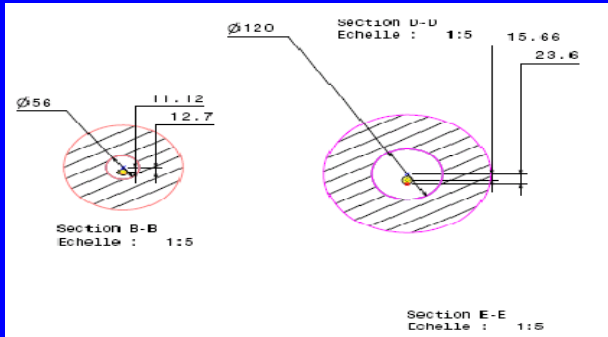

Next :

- Separating the incoming beam and designing the shared region up to QEX1,2 (40 m) and BHEX1 (80 m) for the outgoing and beamstrahlung beams
- Separation of beamstrahlung after BHEX1
- Analyze direct lines of sights to VD through BeamCal mask hole ($r = 1.2$ cm)

Further engineering for final design and costing

- QF, SF & BB1,2 “standard” magnets

LAL (with some local help) & Cockcroft

- “Panofsky” – style large aperture quads

L. Hand & W. Panofsky, Review of Scientific Instruments
Vol. 30, No. 10, 927-930, 1959

Kyoto University + LAL & Cockcroft

- NbTi SC QD & large bore SF for 500 GeV CM

R&D → Nb₃Sn SC QD for 1 TeV upgrade

SC magnet group : KEK ? + LAL & Cockcroft

- Investigate detector integration and push-pull scenarios

LAL & Cockcroft together with existing team on baseline

- Not considered in detail so far : dump and collimators

→ should connect to baseline work on these

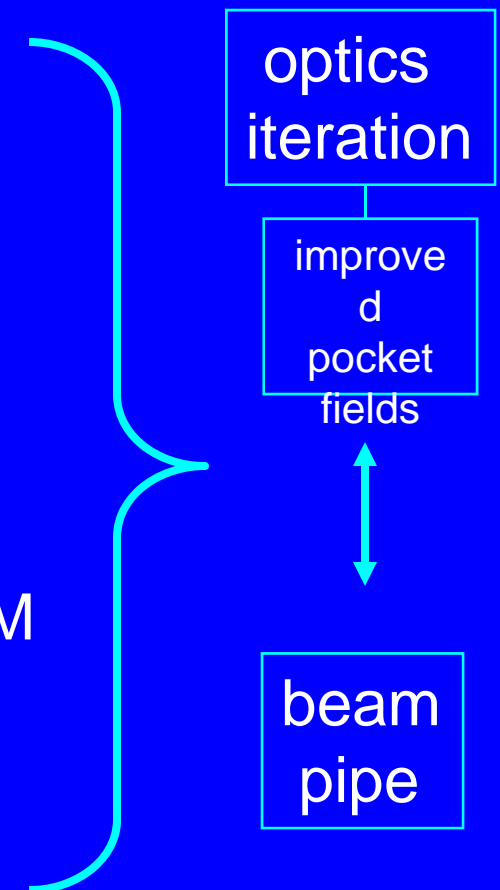

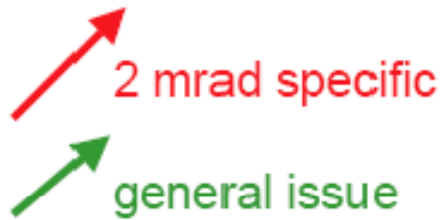

EDR plans

Aim of proposed EDR-phase 2 mrad tasks is to bring the design to the level of a credible alternative to the 14mrad baseline

OK

- 
- **Optics and beam transport**
 - variable I* IR and extraction line layout (CI)
 - further study of extraction line aberrations on final focus beam(CI, LAL)
 - iteration of design and losses as magnet designs progress (LAL, CI)
 - iteration of integration of 2 mrad FD in final focus optics (CI)
 - **Magnet design studies**
 - design of large aperture final horizontal bends BB1 and BB2 (LAL, CI)
 - design of standard warm FD magnets QF1 and SF1 (LAL)
 - design of a modified Panofsky quadrupole magnets (exploring possibilities) [feasibility, cost]
 - engineering design of QD0 and SD0 [feasibility for compact SD0 size, cost]
 - **Other engineering and integration work**
 - Integration of final doublet into detector, including
 - cryostat design and FD support / services
 - anti-solenoid or skew-quadrupoles for coupling correction, with appropriate integration
 - design of beam pipe in shared area (LAL) [detailed drawings critical]
 - design of beam pipe in extraction line (LAL) [detailed drawings critical]

There is real flexibility in this scheme, with margins and adjustable parameters

Luminosity loss without crab-crossing (perfect conditions)

L/L_0
 ~ 0.85

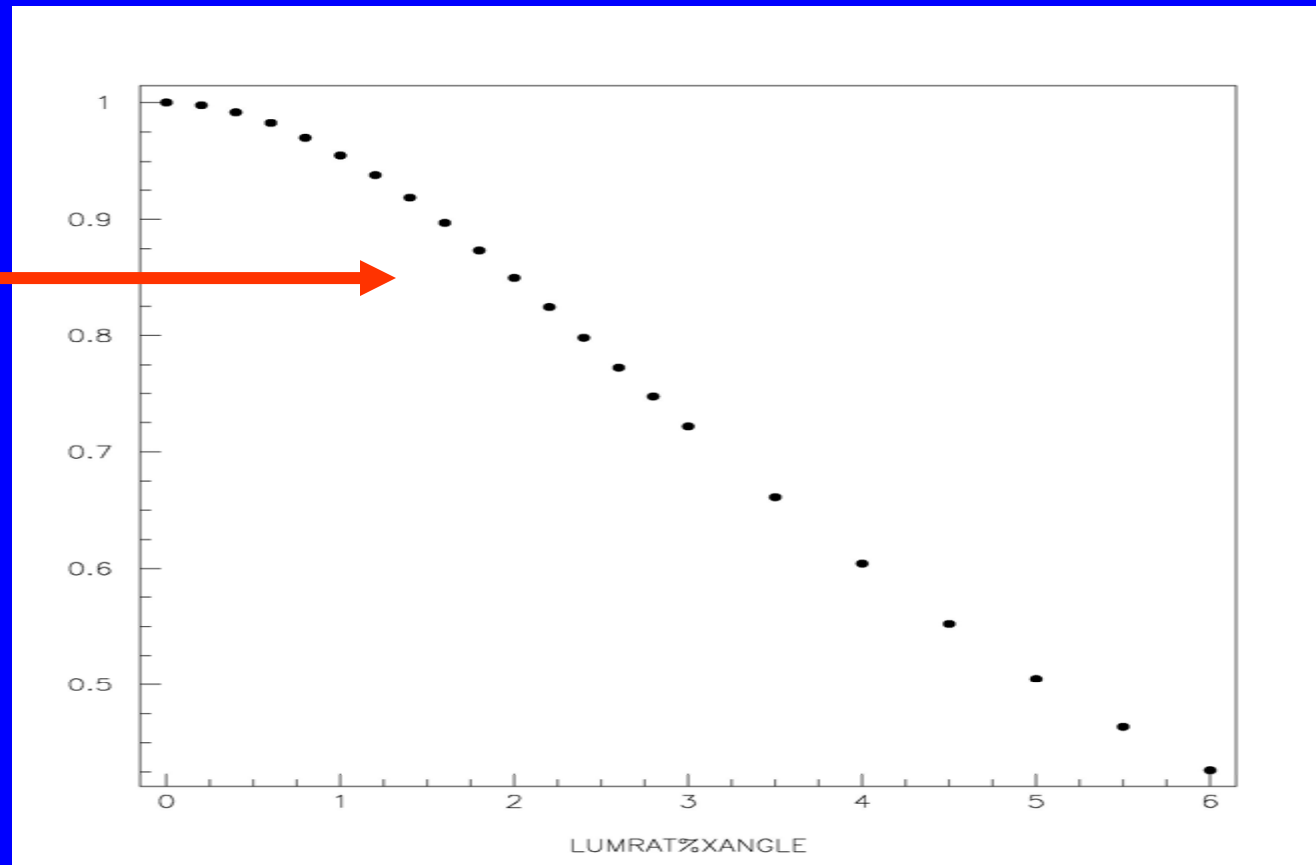

20 mrad $\rightarrow L/L_0 \sim 0.2$

2θ [mrad]

Symmetry consideration and BeamCal mask

GLD

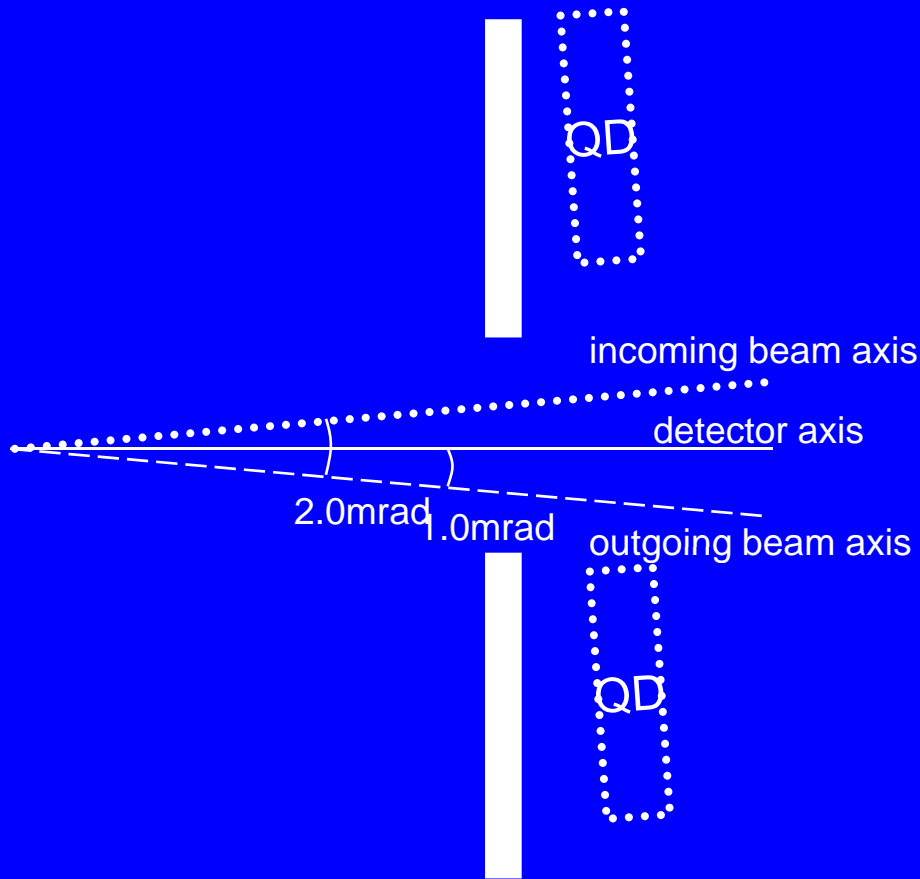

LDC

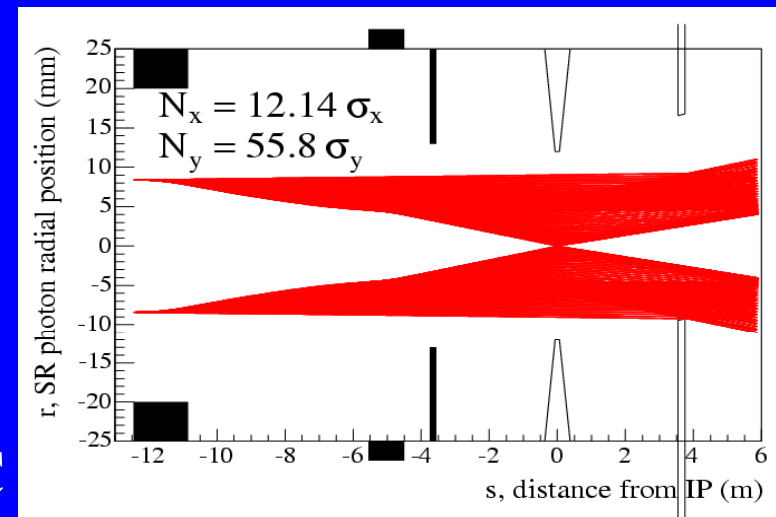
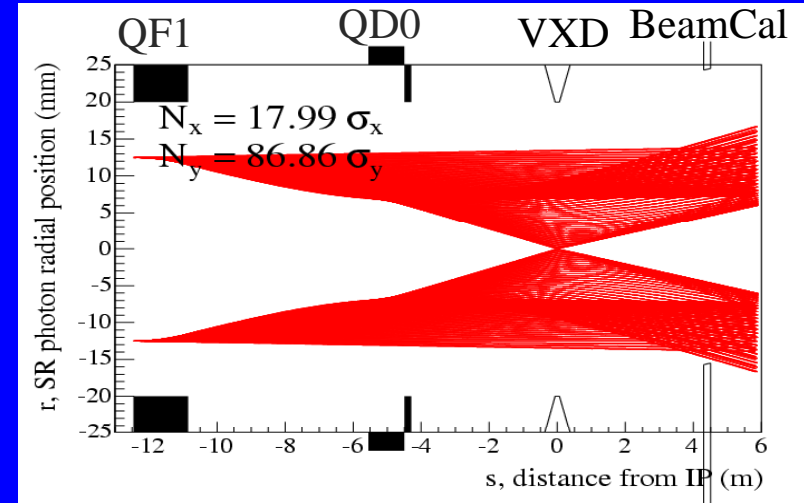

Best case GLD, worst case LDC, but the collimation depths are acceptable

BeamCal with $r = 15\text{mm}$ in LDC, centred on detector axis \rightarrow OK clearances
Effective BeamCal aperture of 7mm radius

Optics for 500 GeV and 1 TeV

EUROTeV-Memo-2007-004

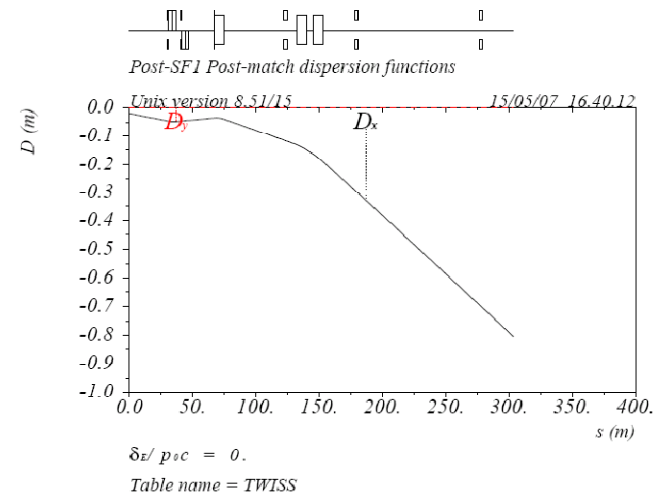
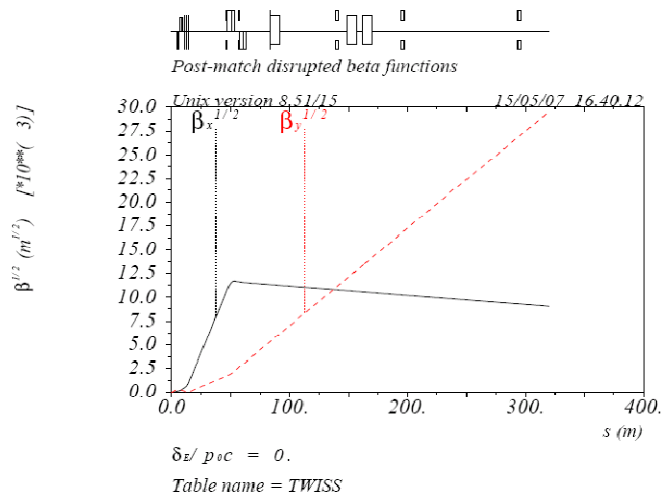
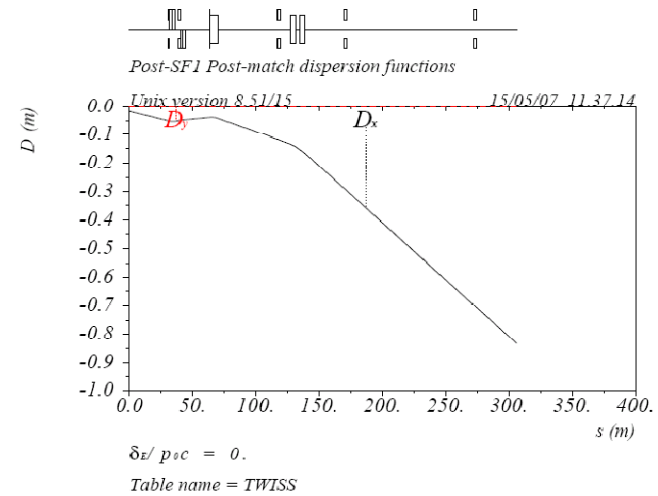
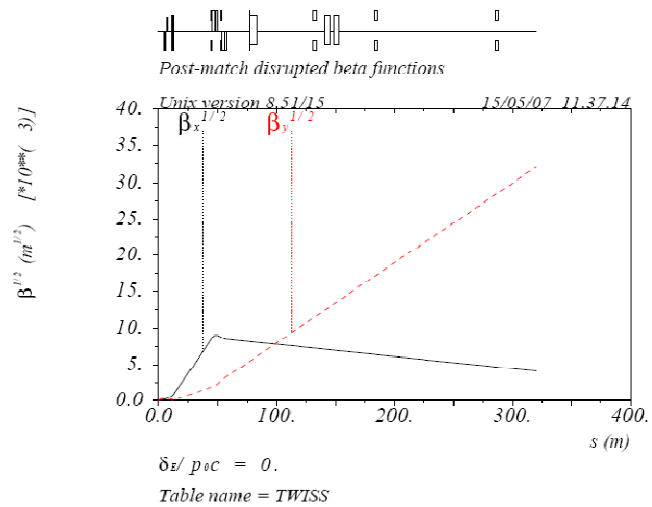

Beam power losses

Beam	QEX1COLL [kW]	QEX1 [kW]	QEX2COLL [kW]	QEX2 [kW]	BHEX1 [kW]	COLL1 [kW]	COLL2 [kW]
Nominal	0	0	0	0	0	0.2	5.1
Nominal (dy=200nm)	0	0	0	0	0	0	2.9
Nominal (dx=1 σ)	0	0	0	0	0	0.7	2.6
Low Power	2.8	0	1.3	0	0	65.3	50.0
Low Power (dy=120nm)	3.6	0	1.4	0	0	69.8	73.8
Low Power (dx=1 σ)	1.4	0	0.7	0	0	34.5	19.3
High Lumi	12.3	0	4.4	0	0	202.1	131.9
High Lumi (dy=120nm)	14.8	0	4.5	0	0	200.0	195.8
High Lumi (dx=1 σ)	8.3	0	2.8	0	0	101.9	49.1

Computed using GUINEA-PIG and DIMAD, for ILC parameter sets at machine energy of 500 GeV, with high statistics. Protection collimator jaws tuned to remove losses on magnets, and main collimator jaws tuned to loss specification of 200 kW and beam size on dump window.



Mokka Simulation & Marlin reco.(2)

γ generated with very small angle

Study the direct lines of sight passing through the BeamCal

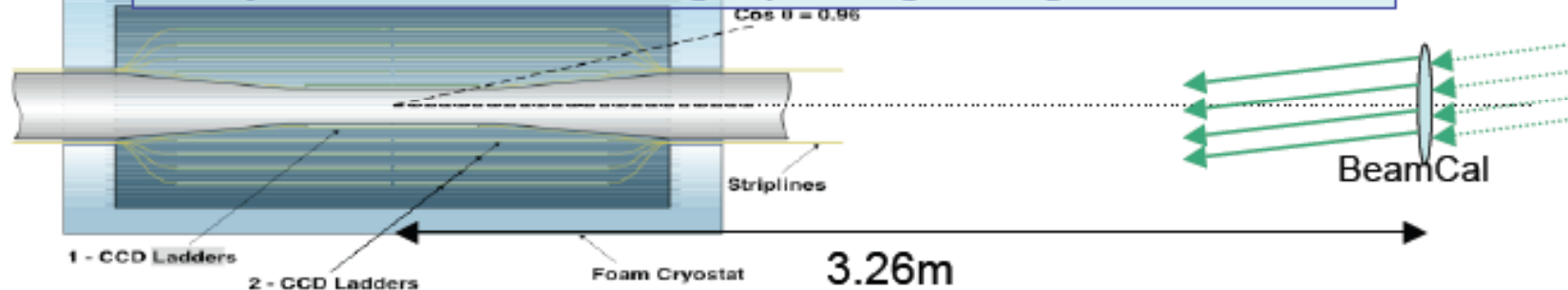

Generate photons: $z=3.26$, Circle(x, y), $r=12\text{mm}$, $\cos\theta=X(20\text{cm})/Z(45\text{m})$
(Beam loss position at QEX1COLL)

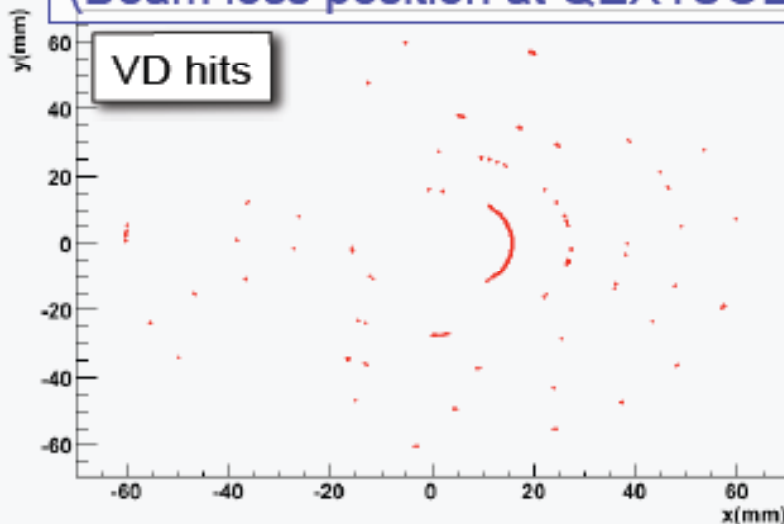

left-right asymmetry. emission point offset in one side

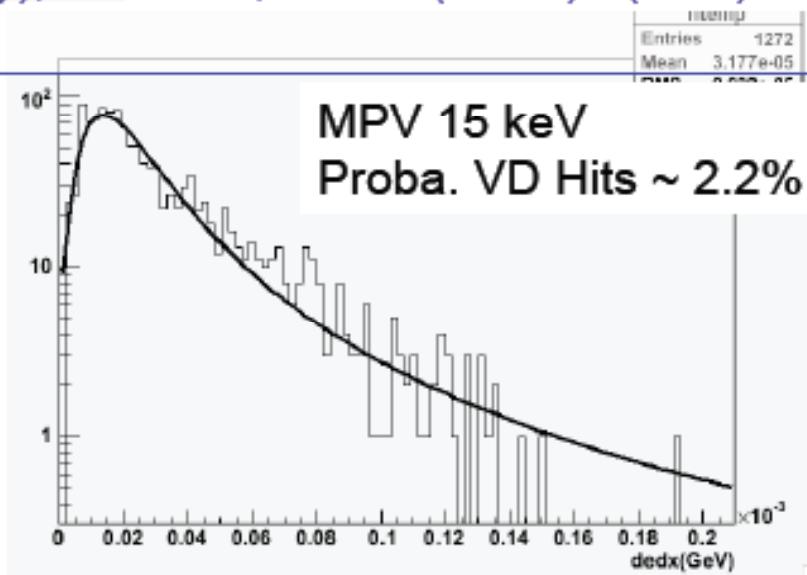

Vertex detector backscattered photon hits from extraction line losses

- BDSIM model of extraction line constructed to assess photon flux towards VD from charged beam losses on the main extraction line collimators
- MOKKA model of the LDC detector to compute hit probability in VD → ~ 2.2%

	D [m]	X [cm]	P [kW]	# γ 's/bx	VD hits / BX
QEX1COLL	45	20	0.2	1.3	0.02
QE2COLL	53	-	0	0	0
BHEX1COLL	76	41	0.1	0.2	0.004
COLL1	131	85	52.3	40	0.8
COLL2	183	115	207.5	82	1.8
COLL3	286	-	0	0	0

(nominal beam parameters)

Conclusion : VD hits negligible from this contribution compared to rate from incoherent beam-beam pairs ~ **250 hits / BX**

Notes: γ 's reach VD layers via direct lines-of-sight from Cu collimator, passing through BeamCal hole with radius 12 mm, assuming no reflections on beam pipe

Beamstrahlung photon cones

Horizontal cone distribution at 500 GeV

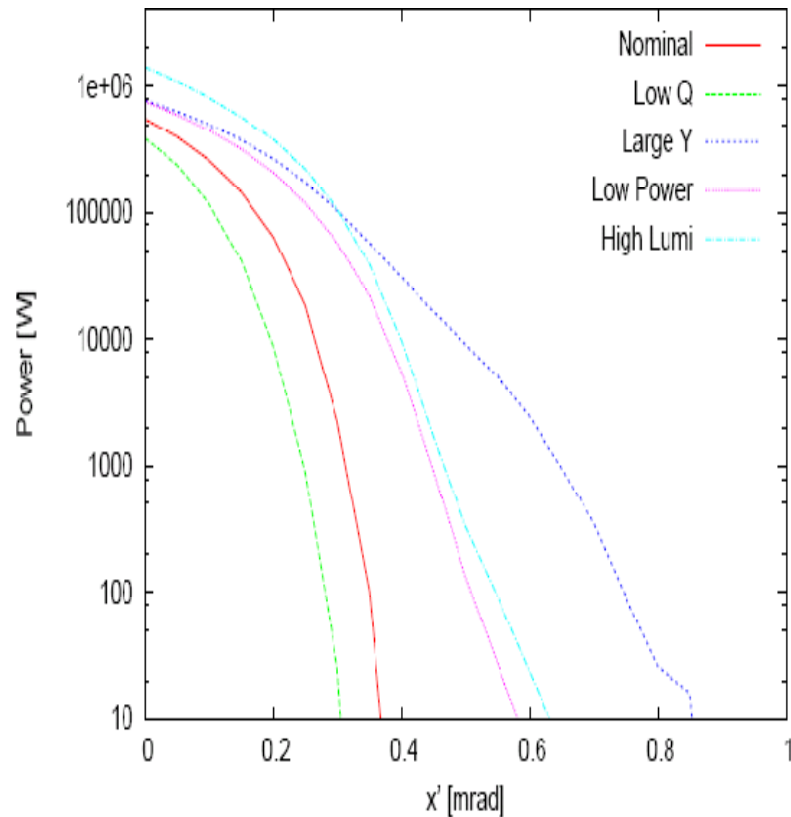

Vertical cone distribution at 500 GeV

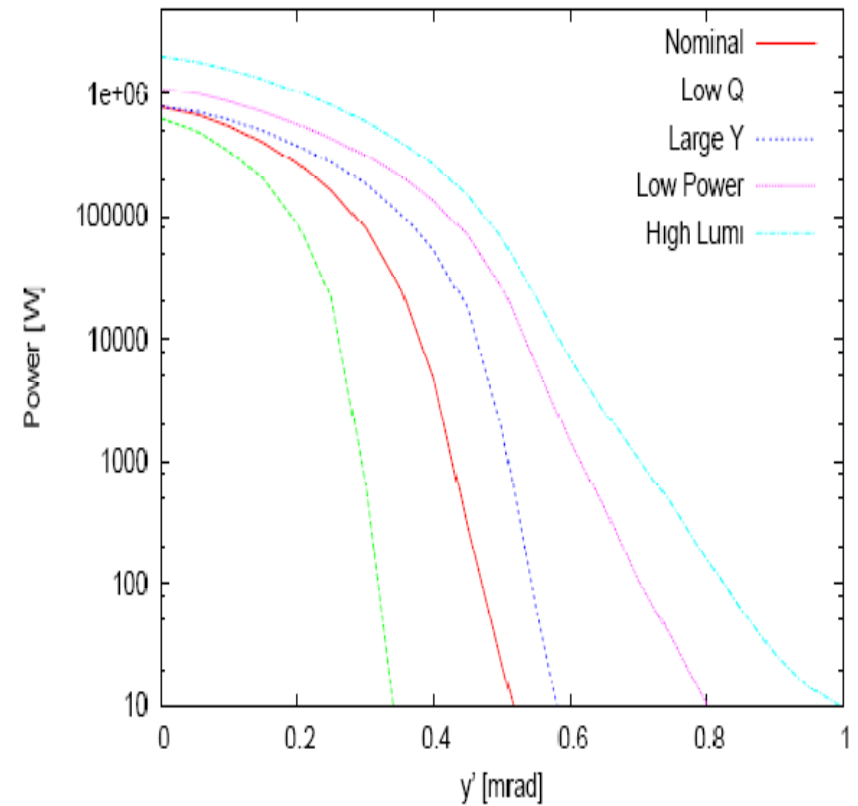

Integrated power beyond half- opening angle

Combined Compton Luminometer & Polarimeter at IP ?!?

CEA/DAPNIA/SEA-97-14

Luminosity Monitor Studies for TESLA

Olivier NAPOLY
CEA, DSM/DAPNIA
CE-Saclay, F-91191 Gif-sur-Yvette Cedex, France

and

Daniel SCHULTE
CERN, PS/LP
CH-1211 Genève 23, Suisse

November 10, 1997

Abstract

The feasibility of a luminosity monitor based on a radiative Bhabha detector is investigated in the context of the TESLA linear collider. Another option based on low energy e^+e^- pair calorimetry is also discussed. In order to monitor the beam parameters at the interaction point by optimizing the luminosity, these detectors should be able to provide a relative measurement of the luminosity with a resolution better than 1% using only a fraction of the TESLA bunch train.

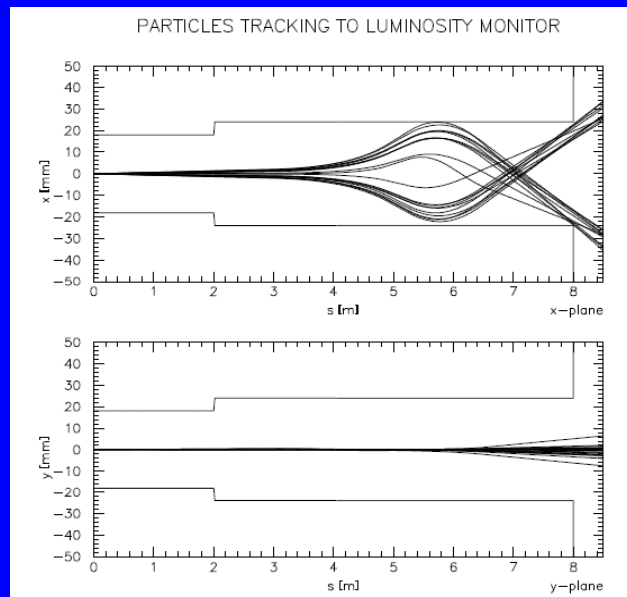
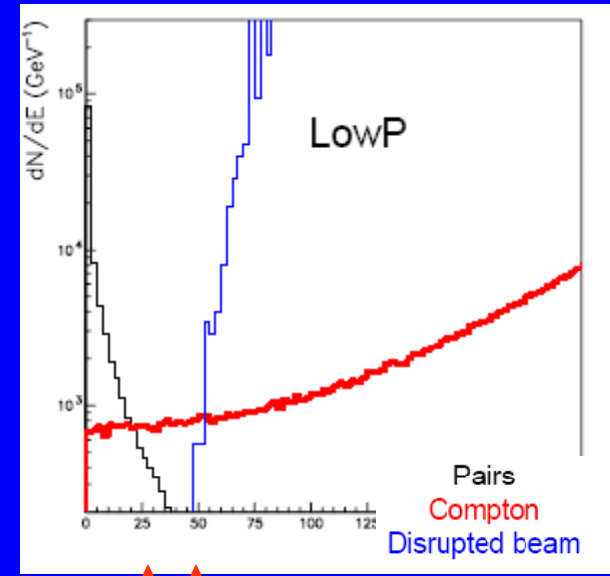
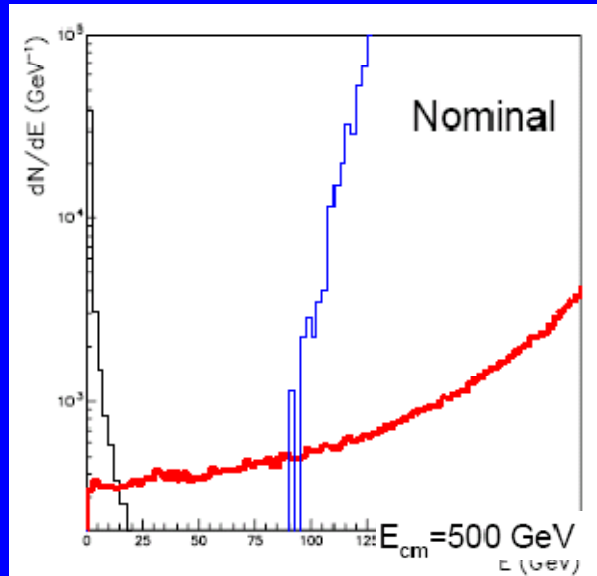

- 4 10^3 luminosity Comptons / BX
- Laser focused 10 m from IP, to 50 μm
 - $\theta_{\text{crossing-angle}} = 5 - 10$ mrad
 - $E_\gamma = 2.33$ eV
 - $\sigma_{z,\gamma} = 10$ ps
 - with $\langle P \rangle = 25 - 50$ W
- 2 - 4 10^4 Comptons / BX

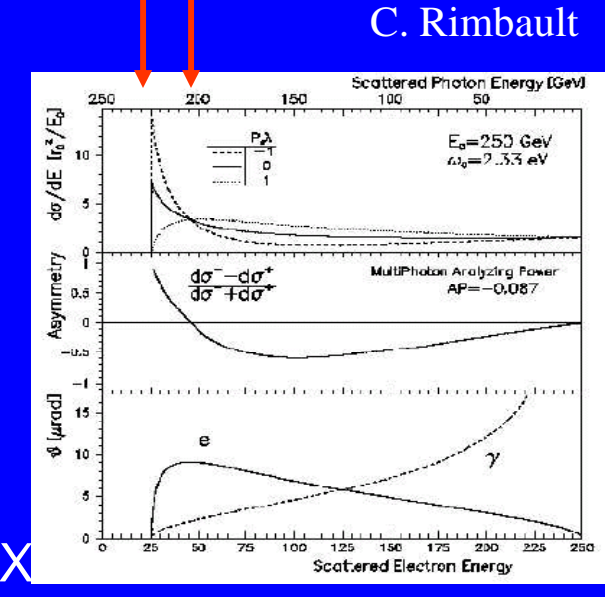

Collection efficiency ~ 5-10%

VERY PRELIMINARY

P. Schüller

Combined Compton Luminometer & Polarimeter at IP ?!?

CEA/DAPNIA/SEA-97-14

Luminosity Monitor Studies for TESLA

Olivier NAPOLY
CEA, DSM/DAPNIA
CE-Saclay, F-91191 Gif-sur-Yvette Cedex, France
and
Daniel SCHULTE
CERN, PS/LP
CH-1211 Genève 23, Suisse
November 10, 1997

Abstract

The feasibility of a luminosity monitor based on a radiative Bhabha detector

PARTICLES HITTING LUMINOSITY MONITOR

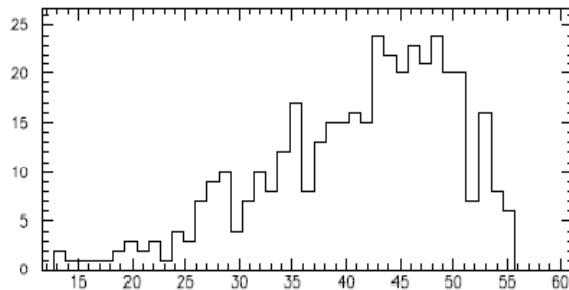

Energy Distribution

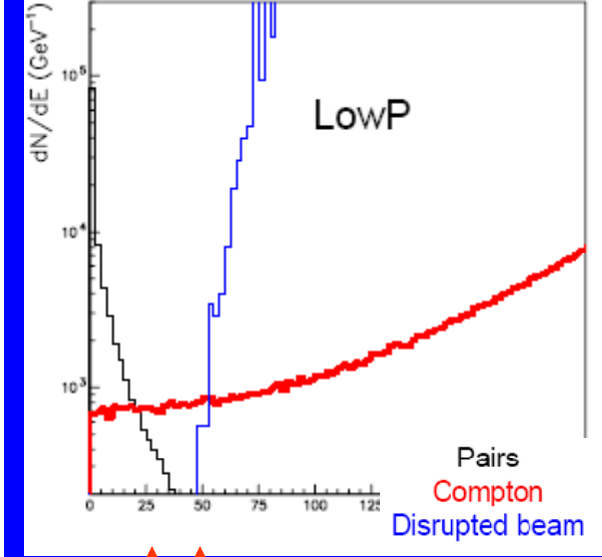
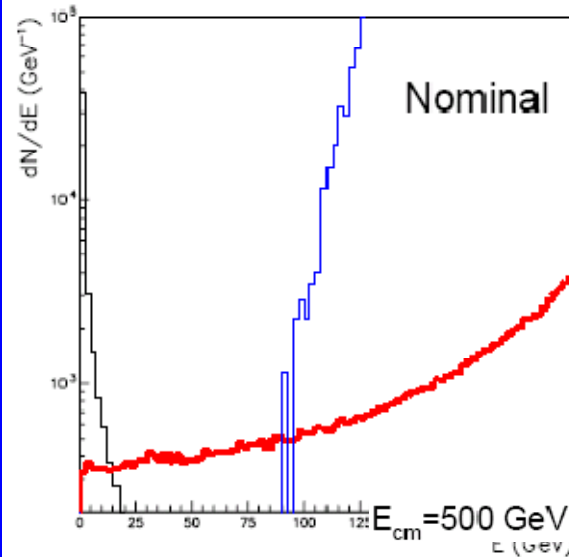
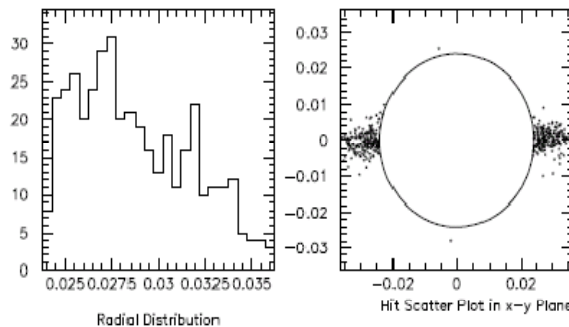

Pairs
Compton
Disrupted beam

$4 \cdot 10^3$ luminosity
Comptons / BX

- Laser focused 10 m from IP, to 50 μm
 - $\theta_{\text{crossing-angle}} = 5 - 10$ mrad
 - $E_{\gamma} = 2.33$ eV
 - $\sigma_{z,\gamma} = 10$ ps
 - with $\langle P \rangle = 25 - 50$ W
- $\rightarrow 2 - 4 \cdot 10^4$ Comptons / BX

C. Rimbault

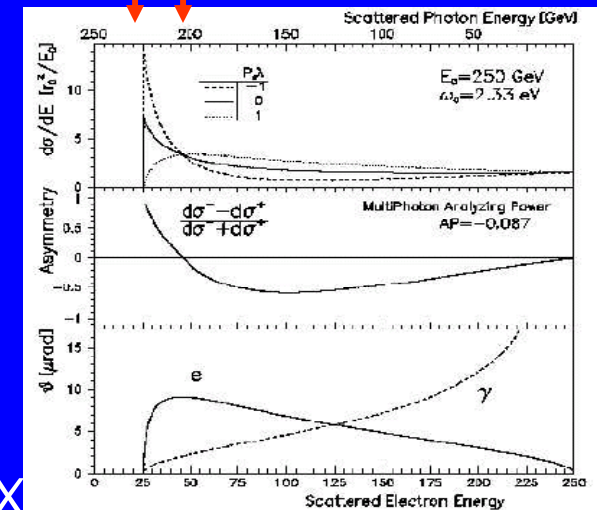

Collection efficiency ~ 5-10%

VERY PRELIMINARY

P. Schüler

Connected beam dynamics and MDI investigations

Not 2 mrad specific → combine with head-on & 14 mrad work

- Spent beam diagnostics to monitor IP beam sizes & offsets
- Impact of non-axial detector solenoid and pre / post-IP trajectory bumps on beam setup and optical tuning
- Detector background from beam and SR losses
- Post-IP relative energy & energy spread measurements
- IP Compton luminometry and polarimetry with high power laser and instrumented mask near the FD
- Optical tuning strategy and feedback algorithms