

LCTPC WP meeting #61

FEC Support Structure for the ALTRO Electronics

Anders Oskarsson, Robert Volkenborn

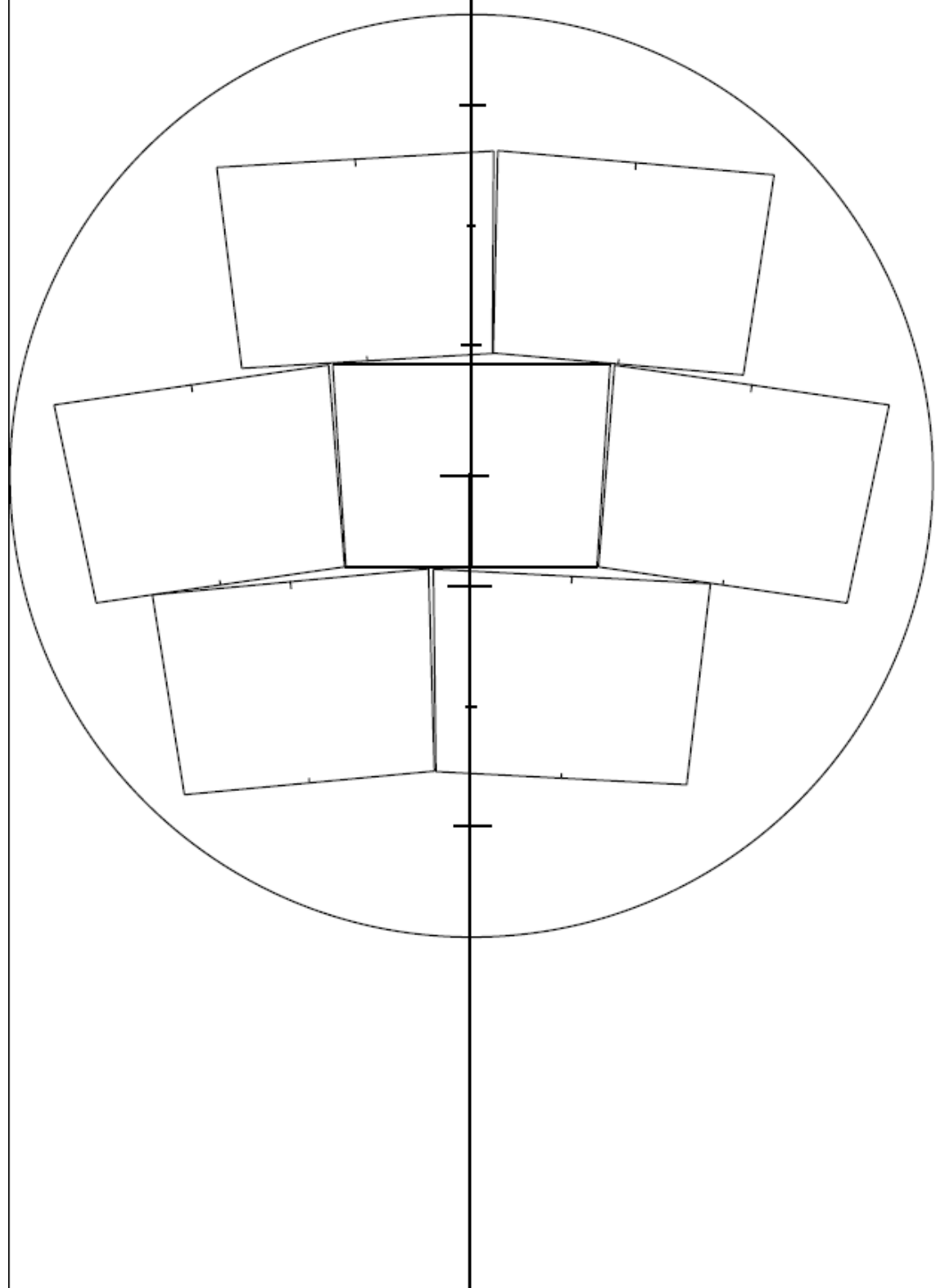

TPC side view (length not to scale)

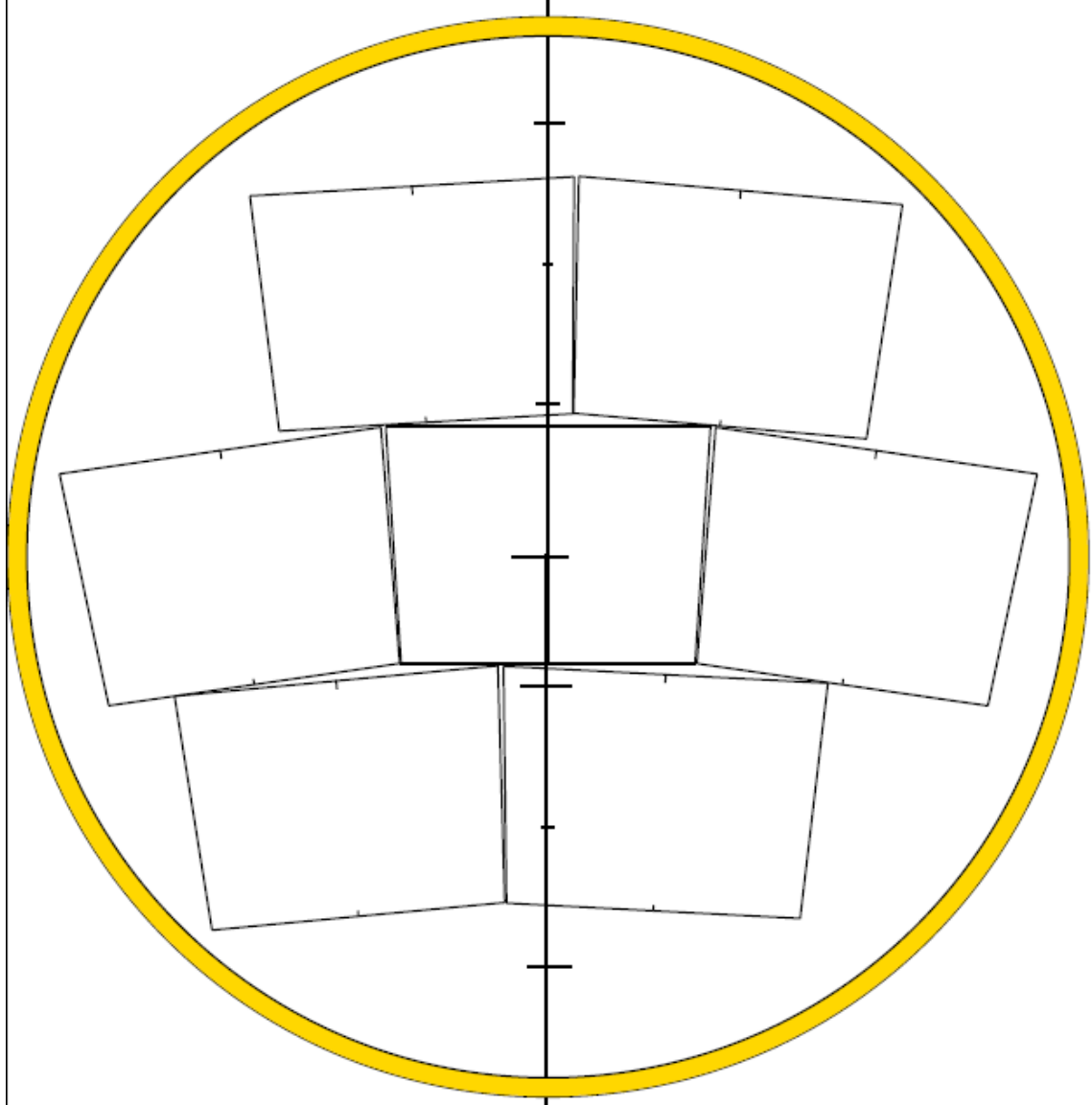

TPC side view (length not to scale)



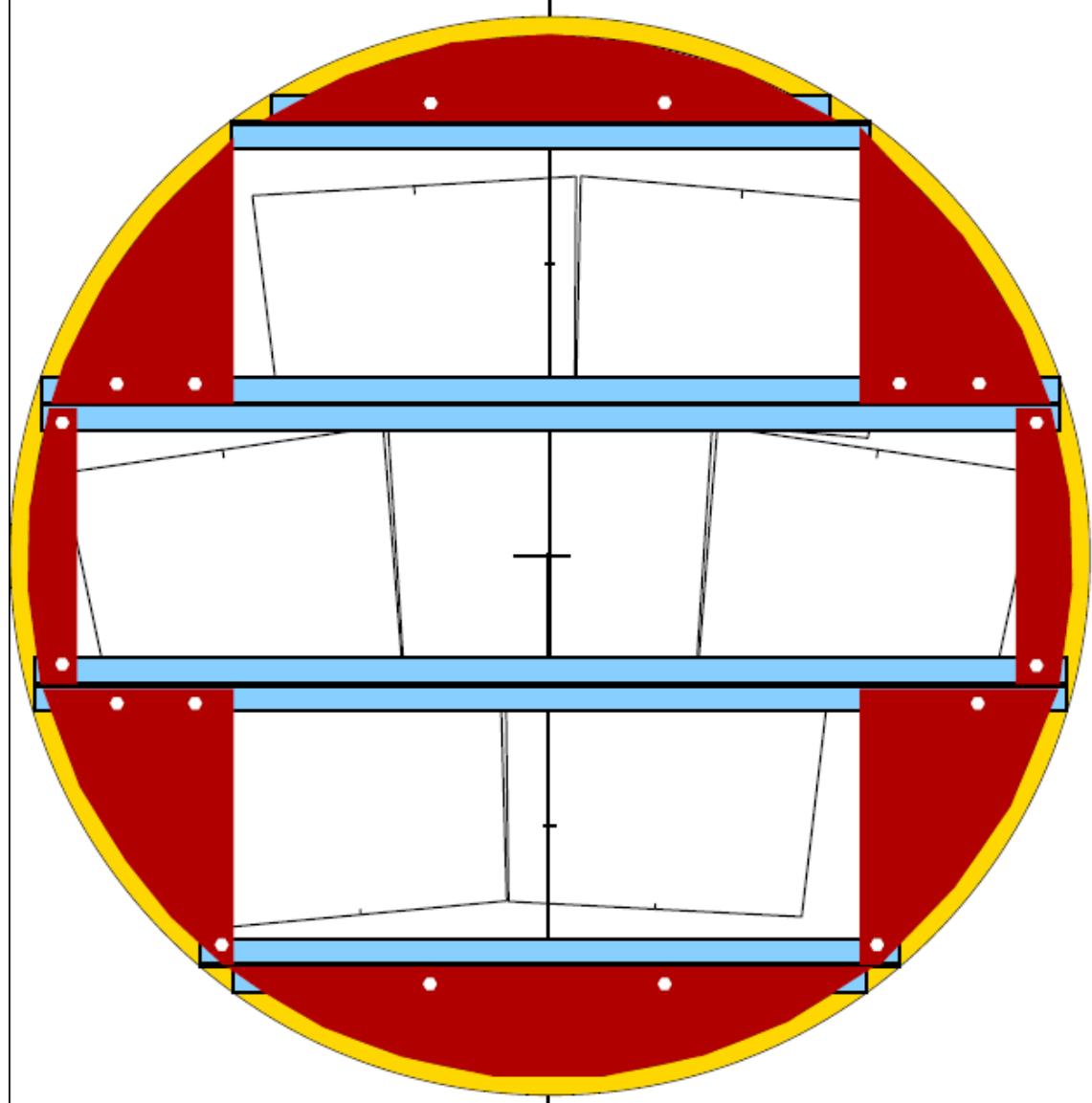

TPC side view (length not to scale)

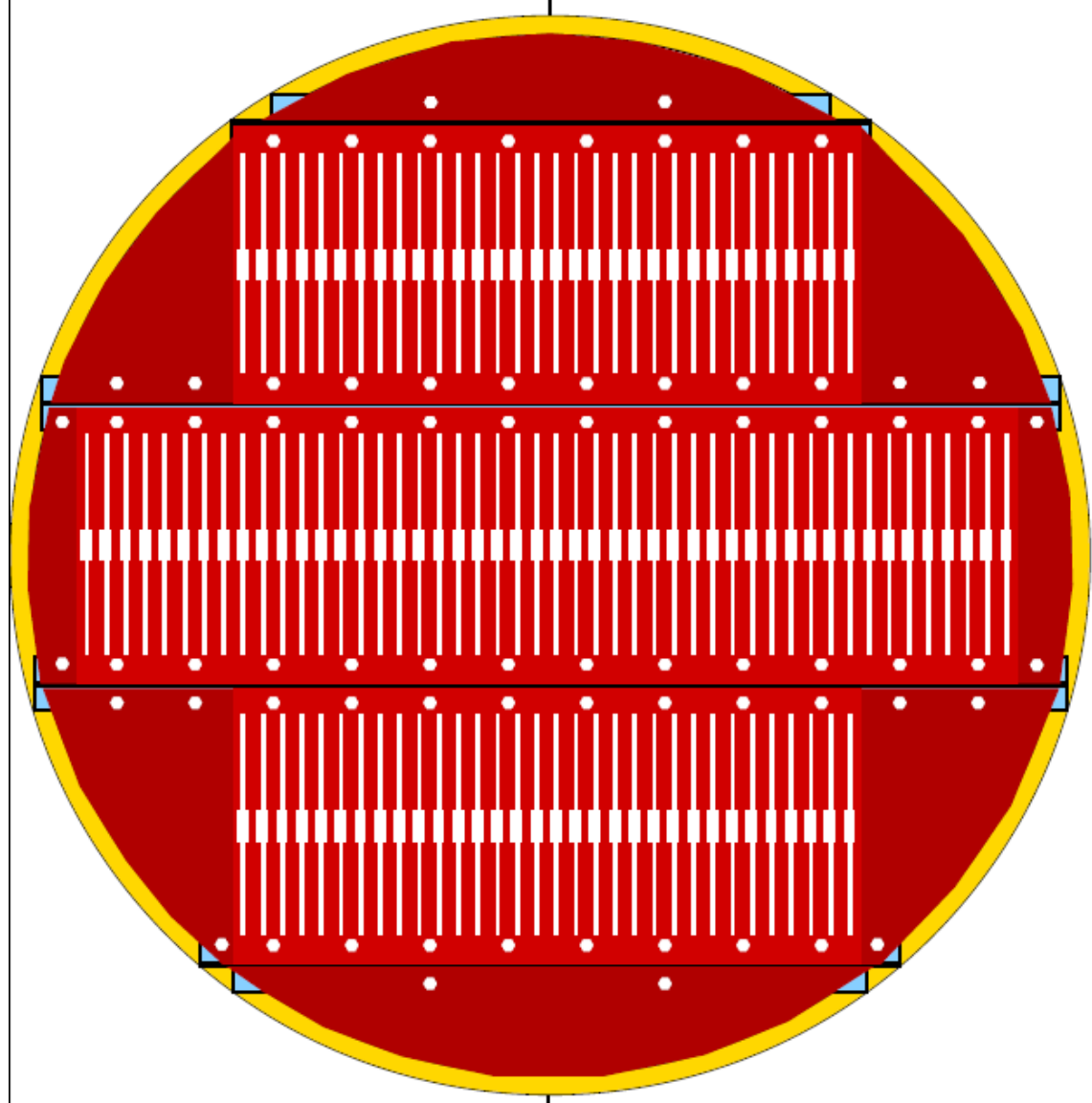

TPC side view (length not to scale)



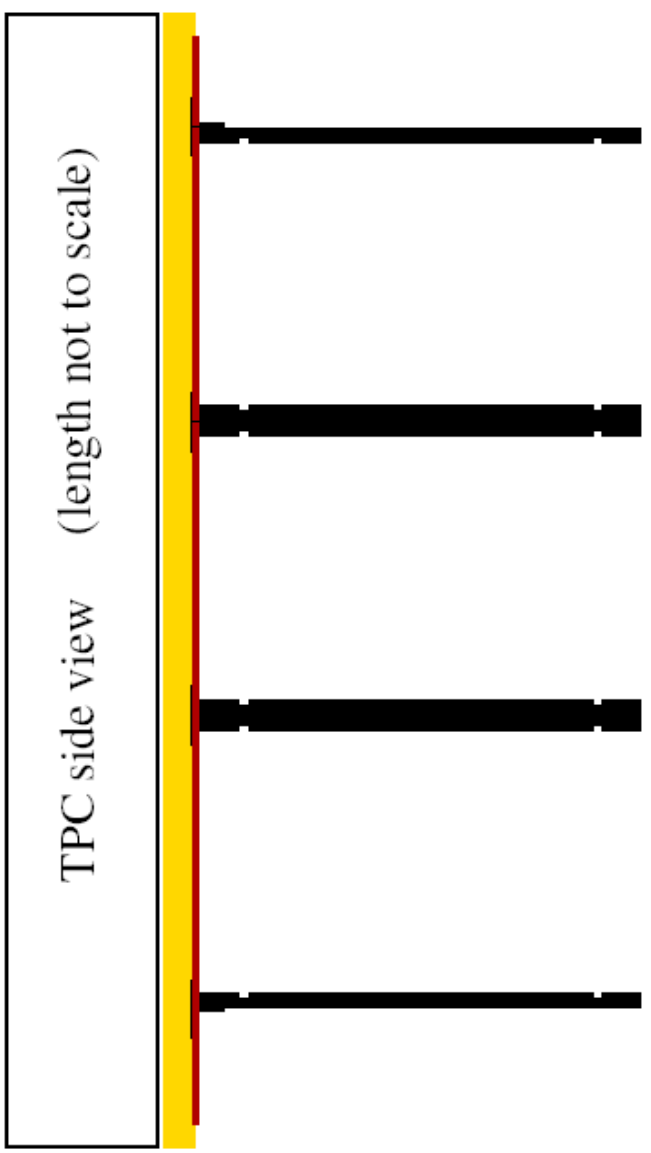
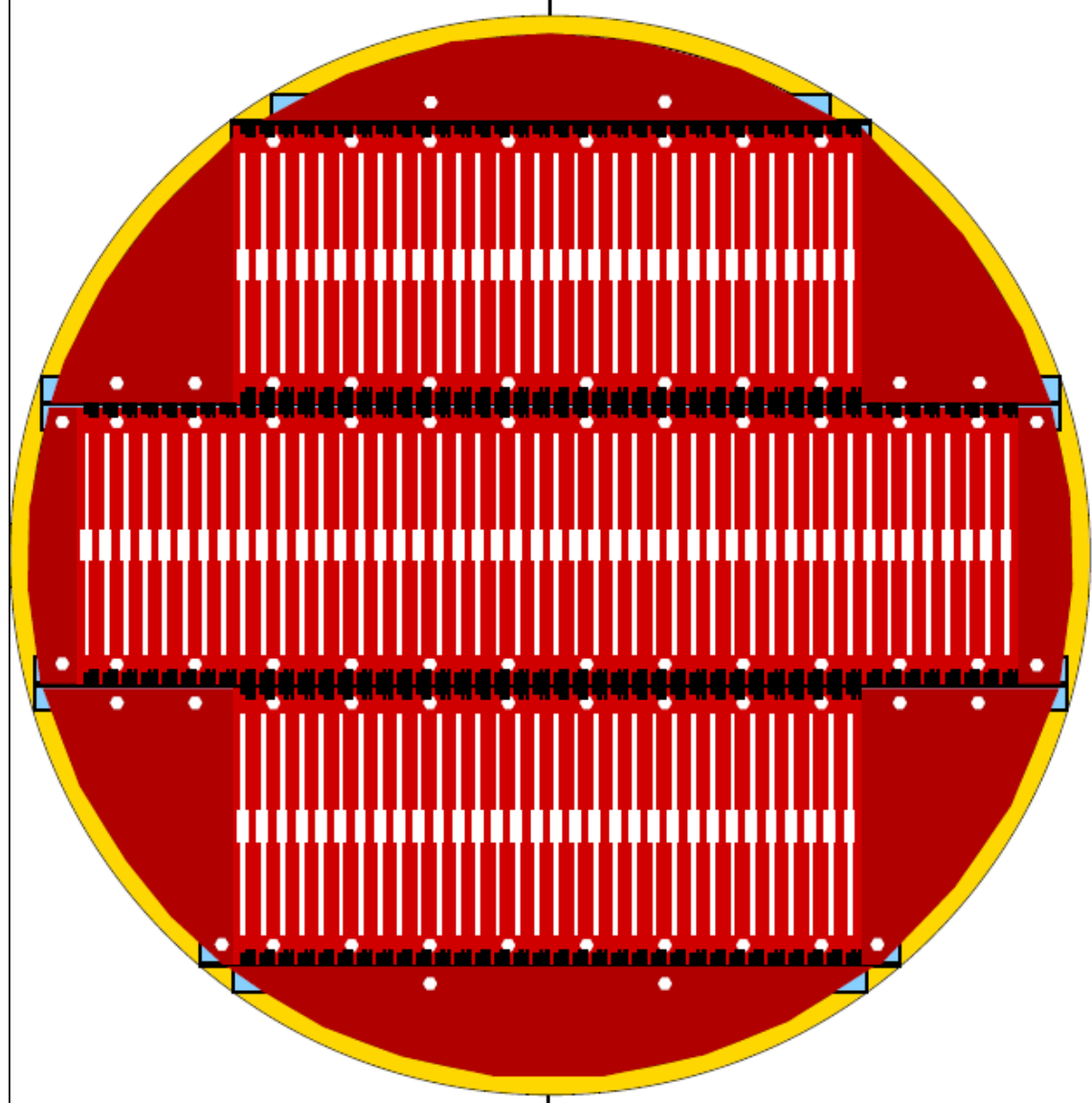

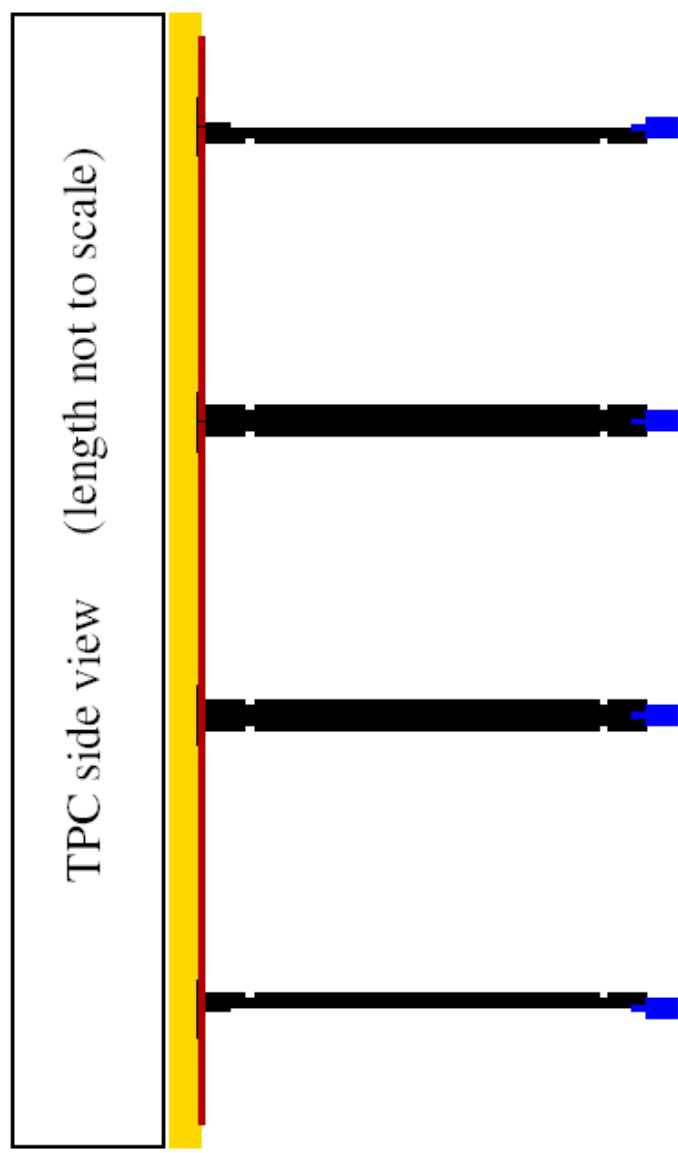
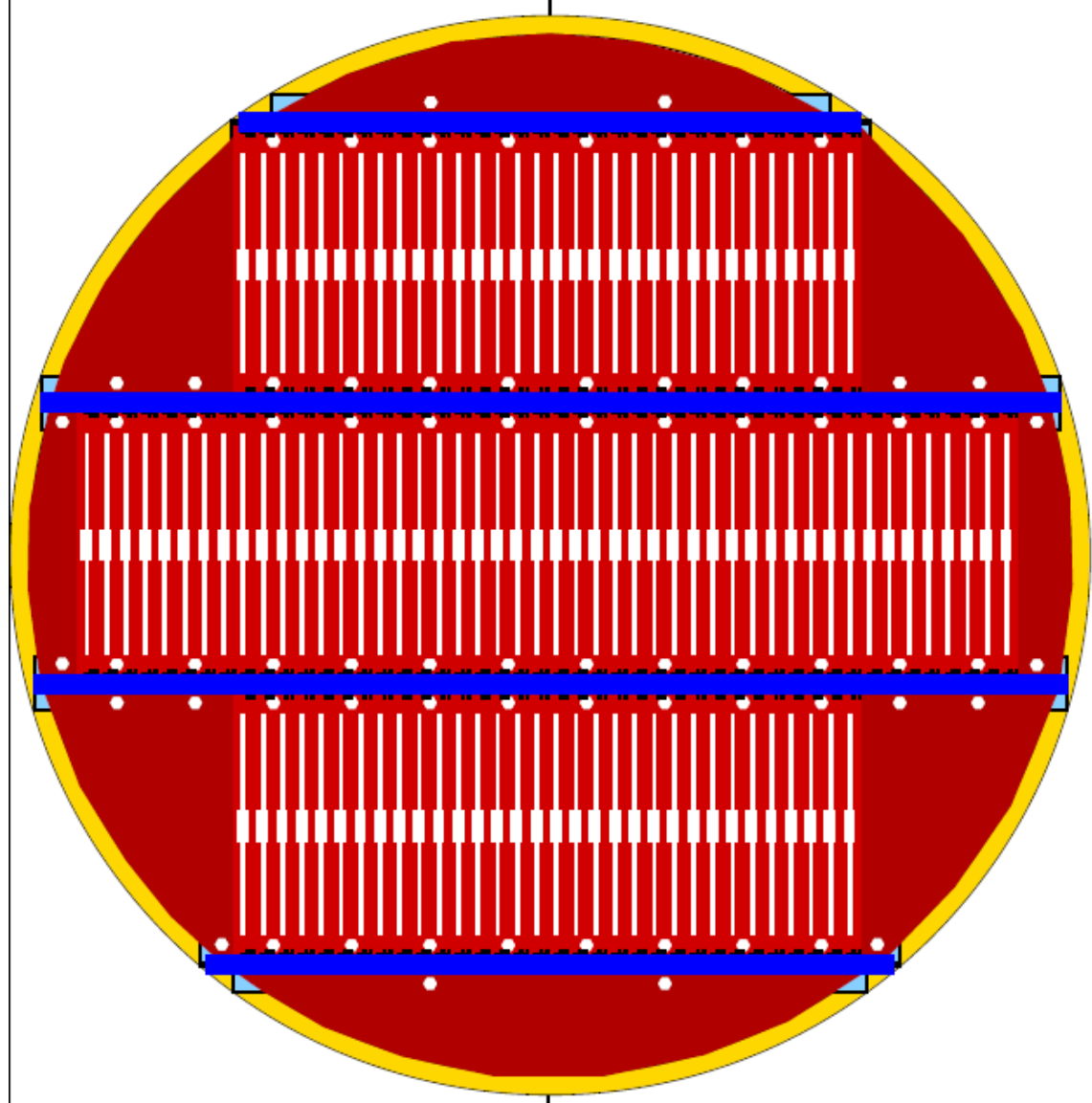

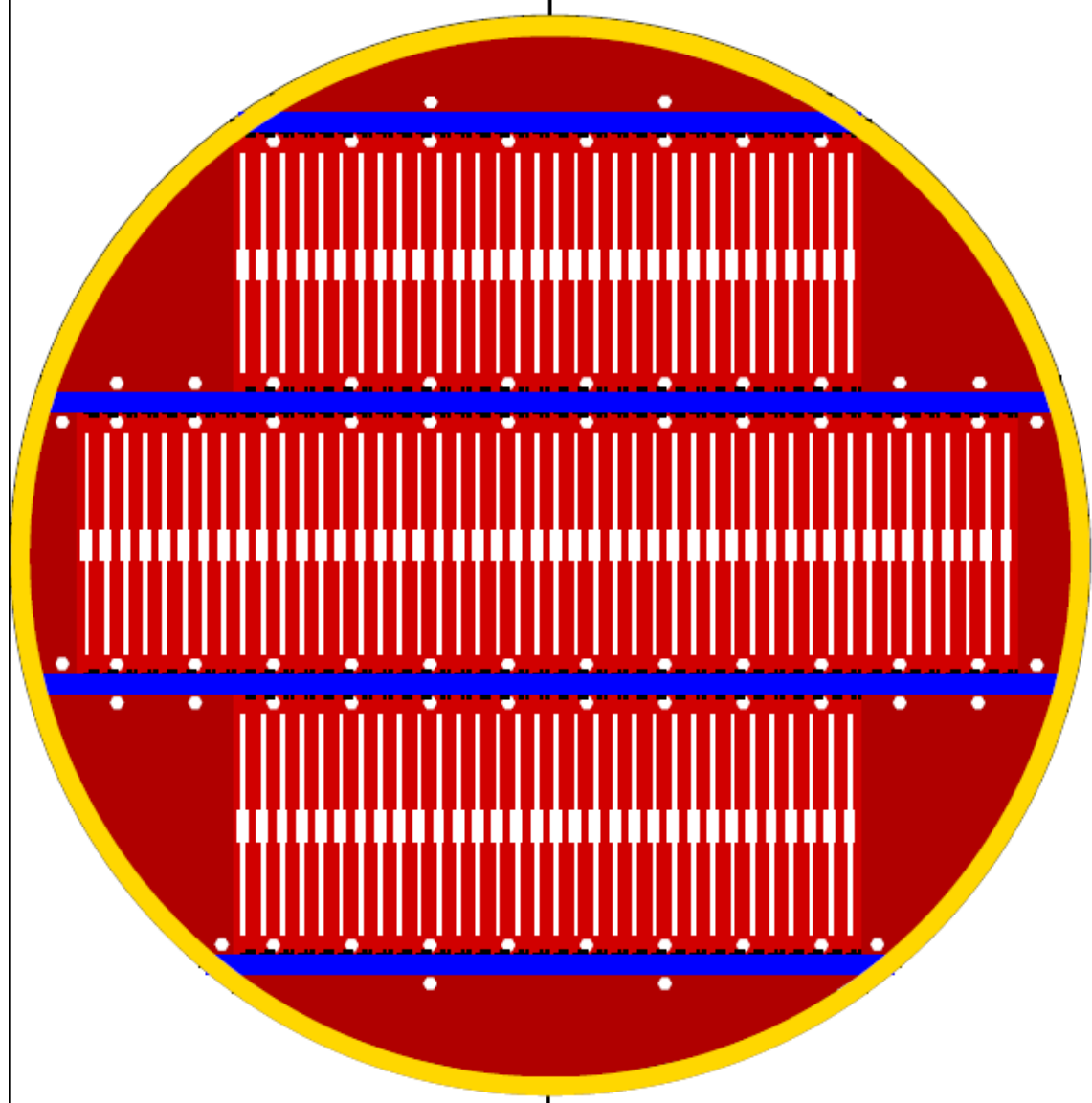

TPC side view (length not to scale)

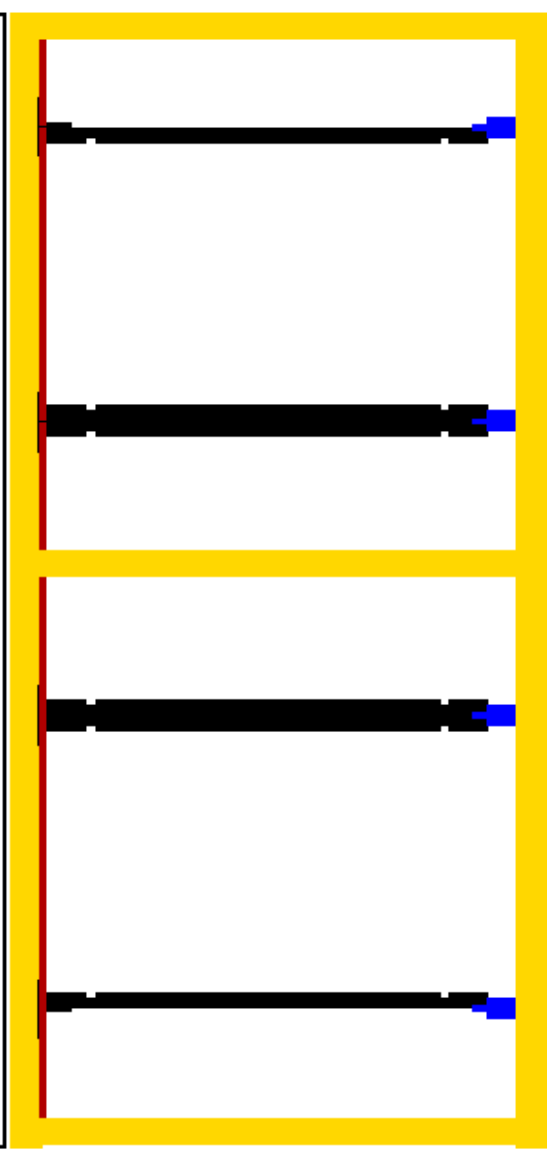

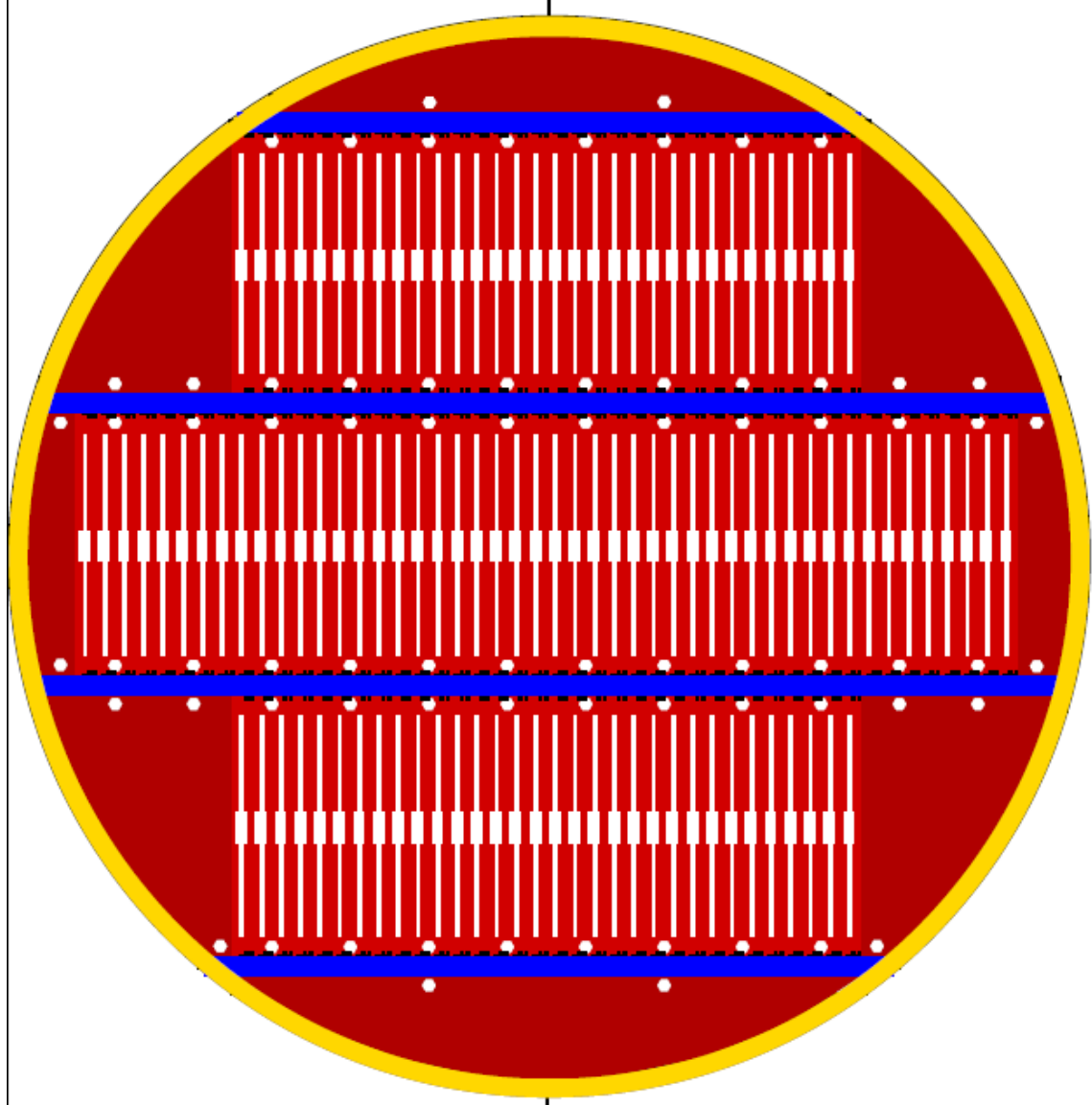

TPC side view (length not to scale)

