

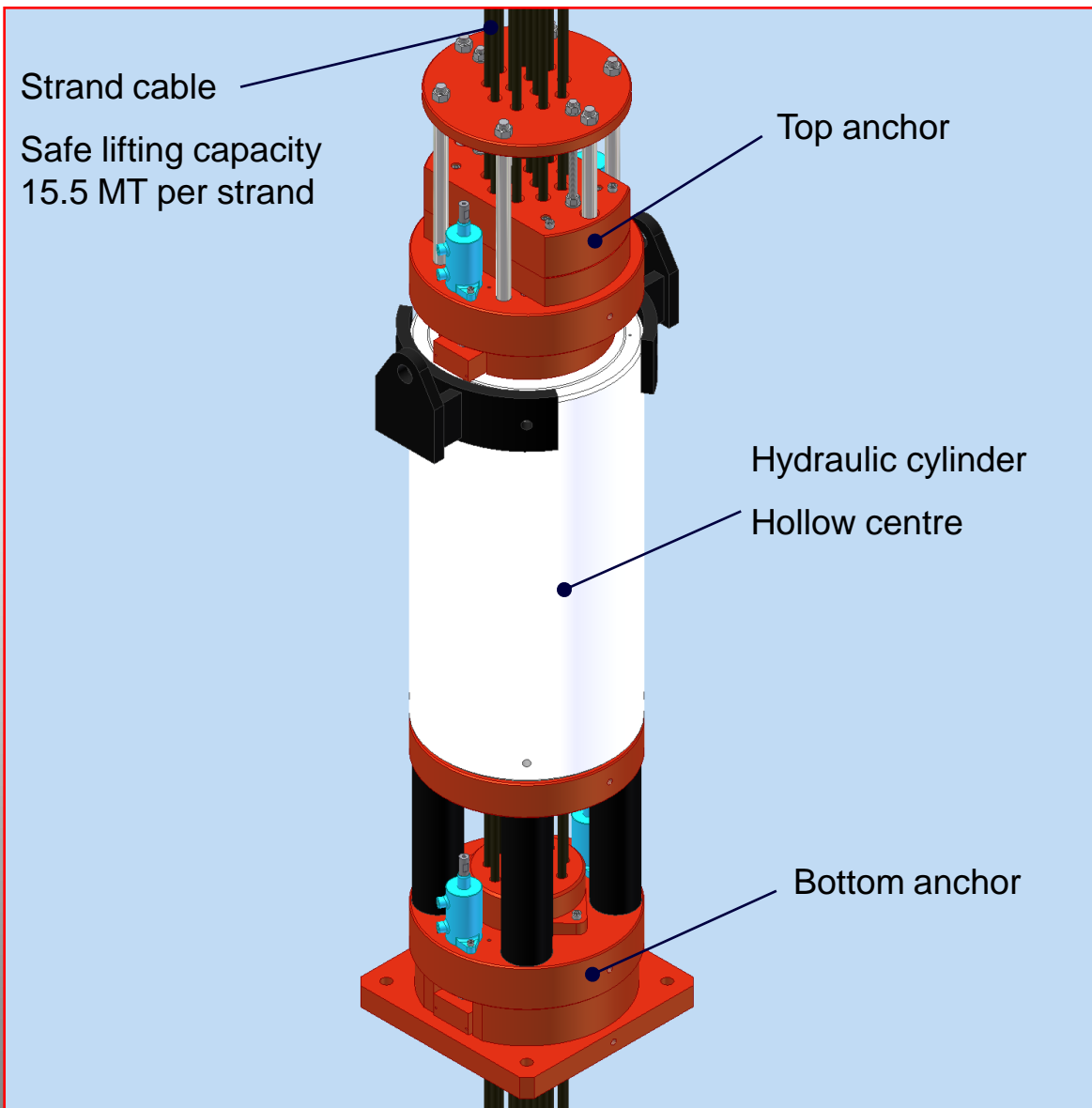

DLT strand jacks
Operating sequences



technology

General view of strand jack

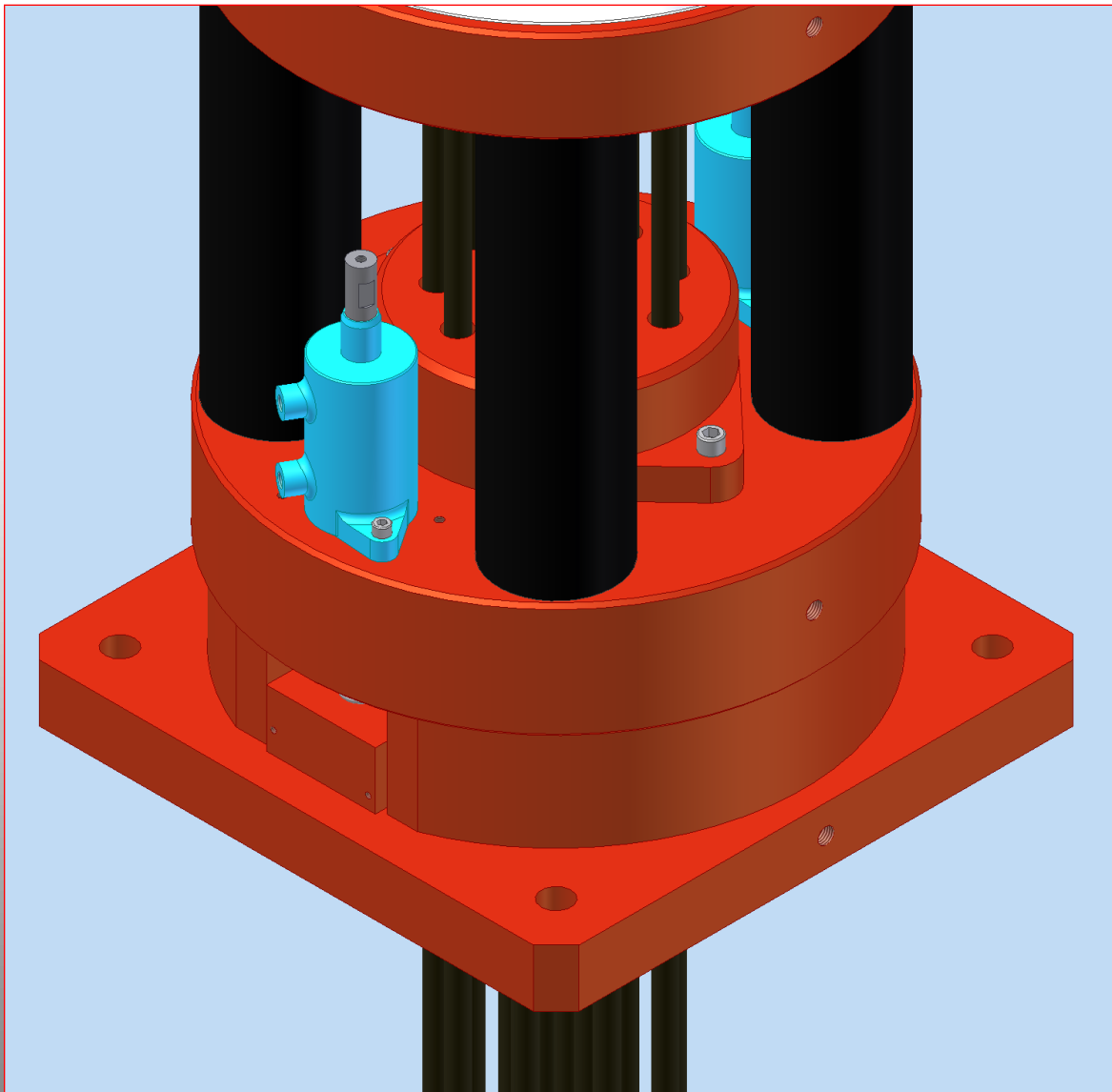

DL technology

General view of bottom anchor

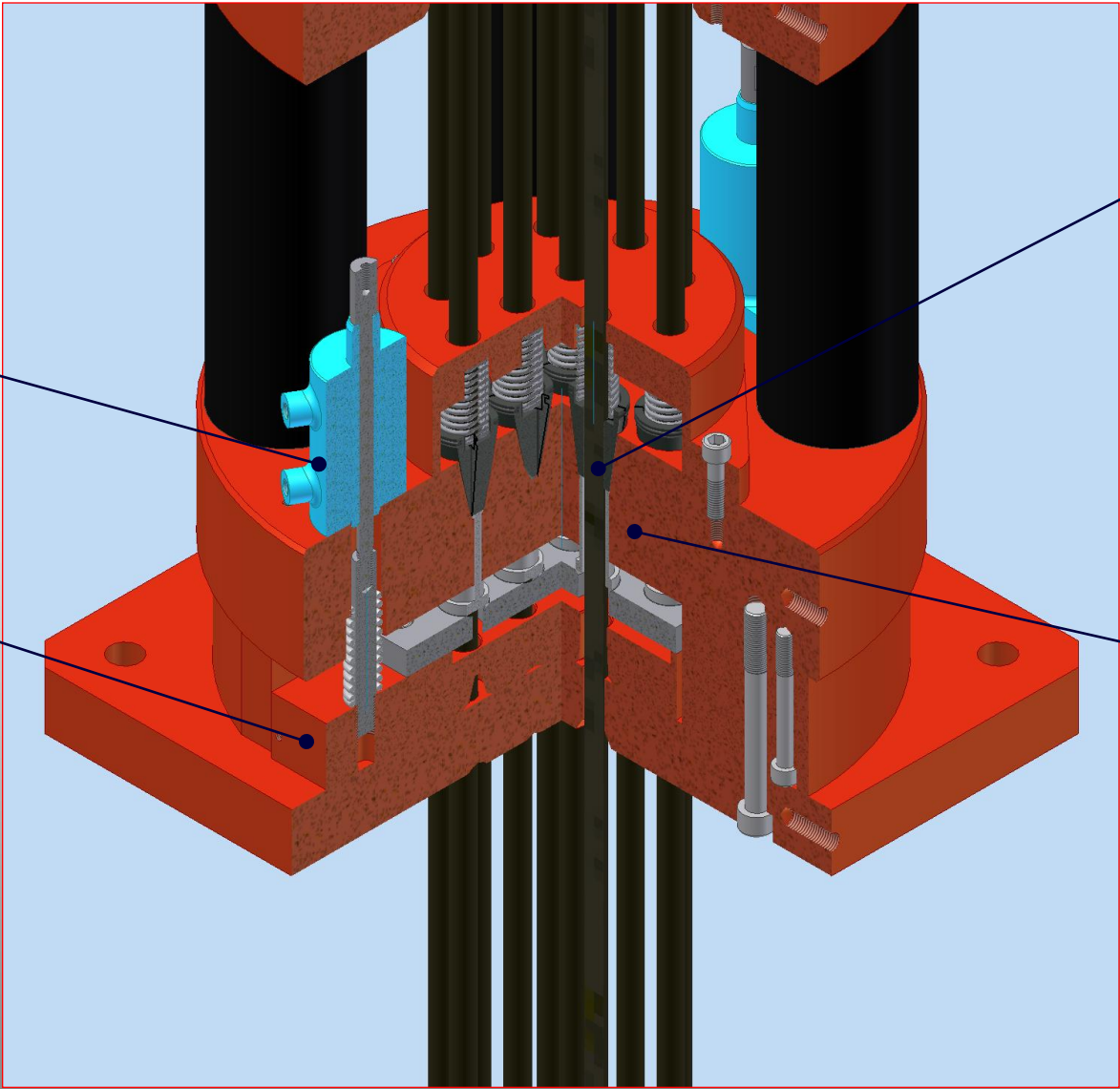

Strand wedges

Grip strand when closed

Grip opening jack

Grip opening Plate. Connected to grip release tubes

Anchor block, with machined cones for strand wedges

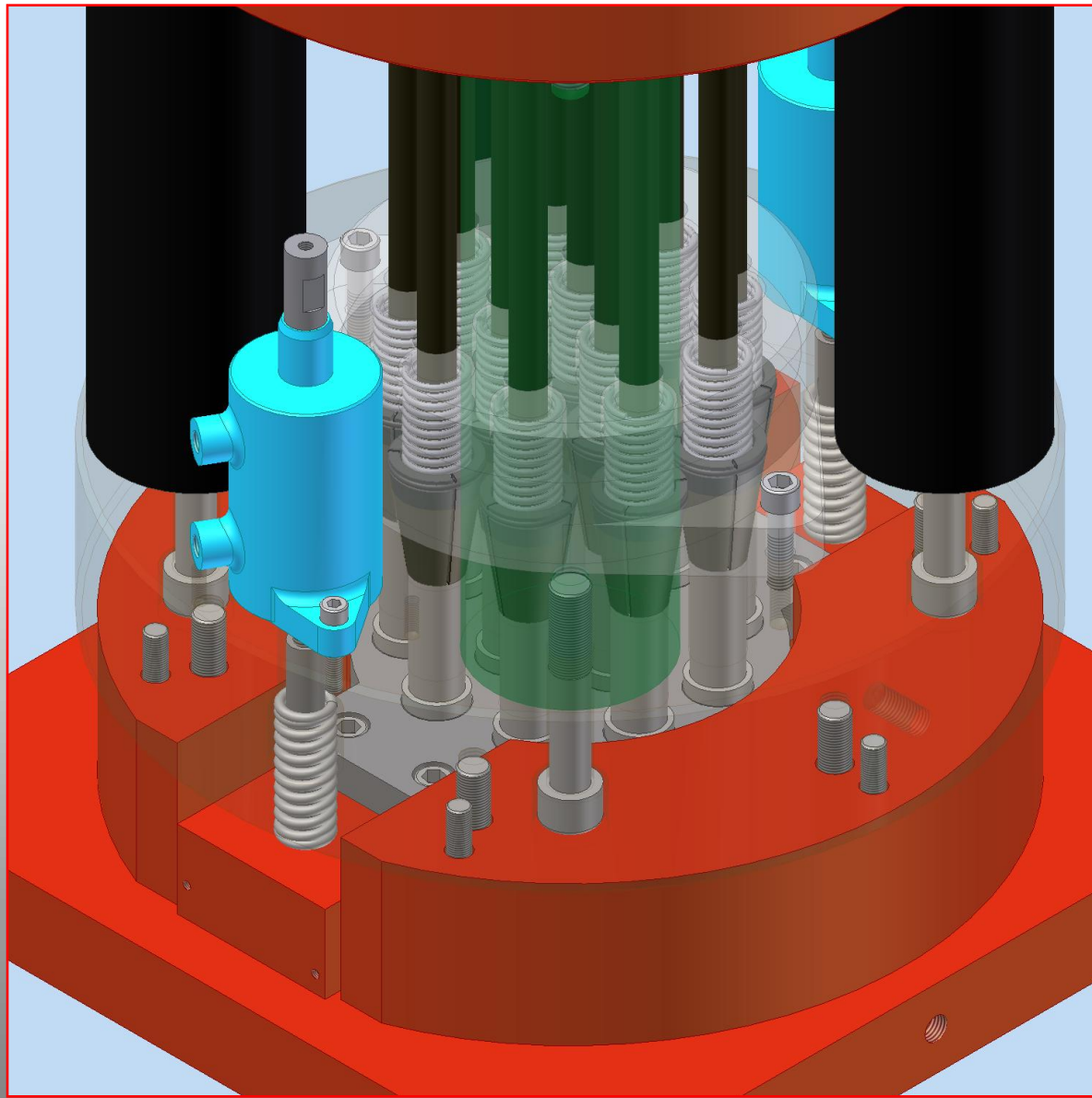

technology

Operation of bottom anchor - closed

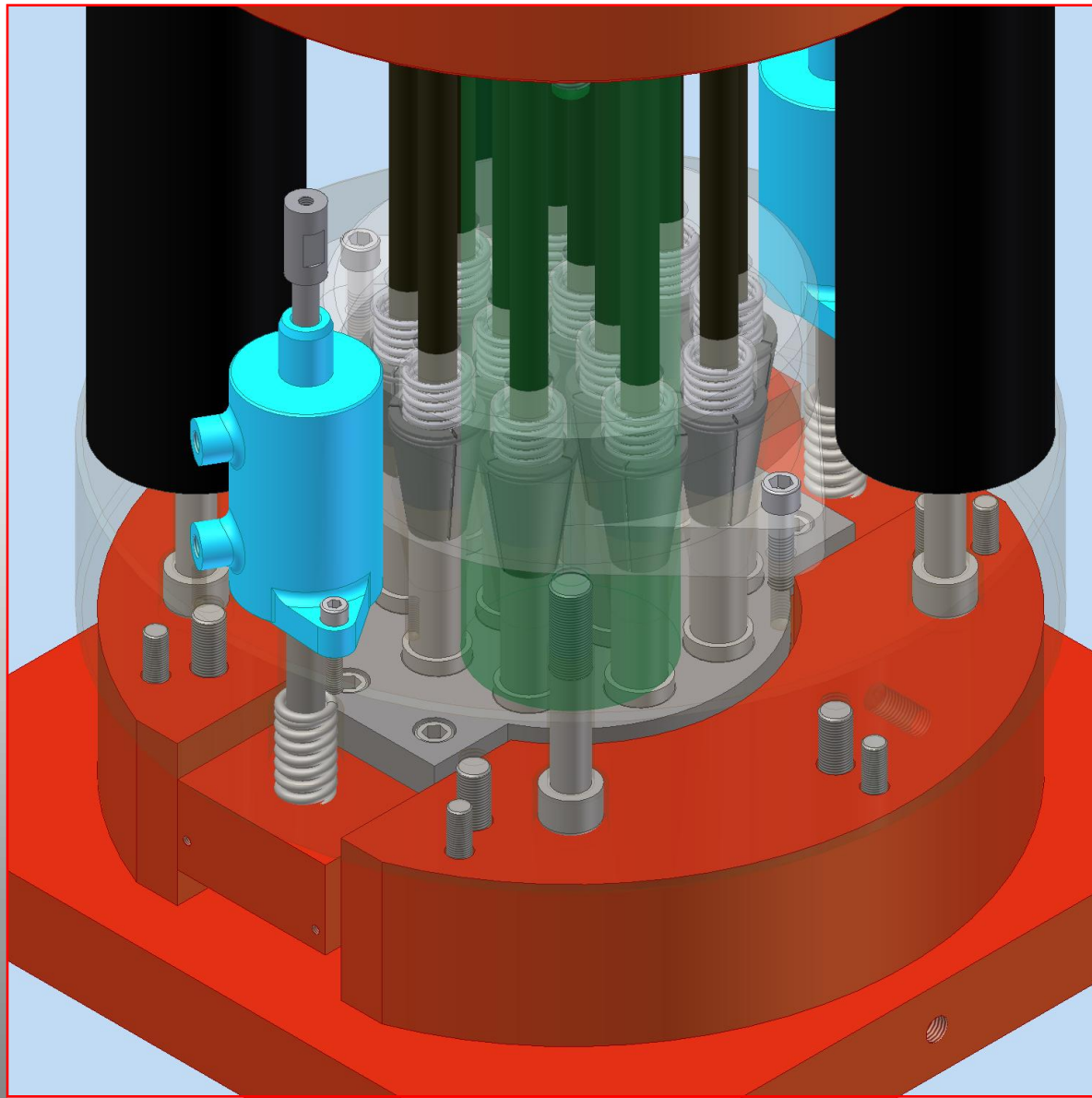

technology

Operation of bottom anchor - open

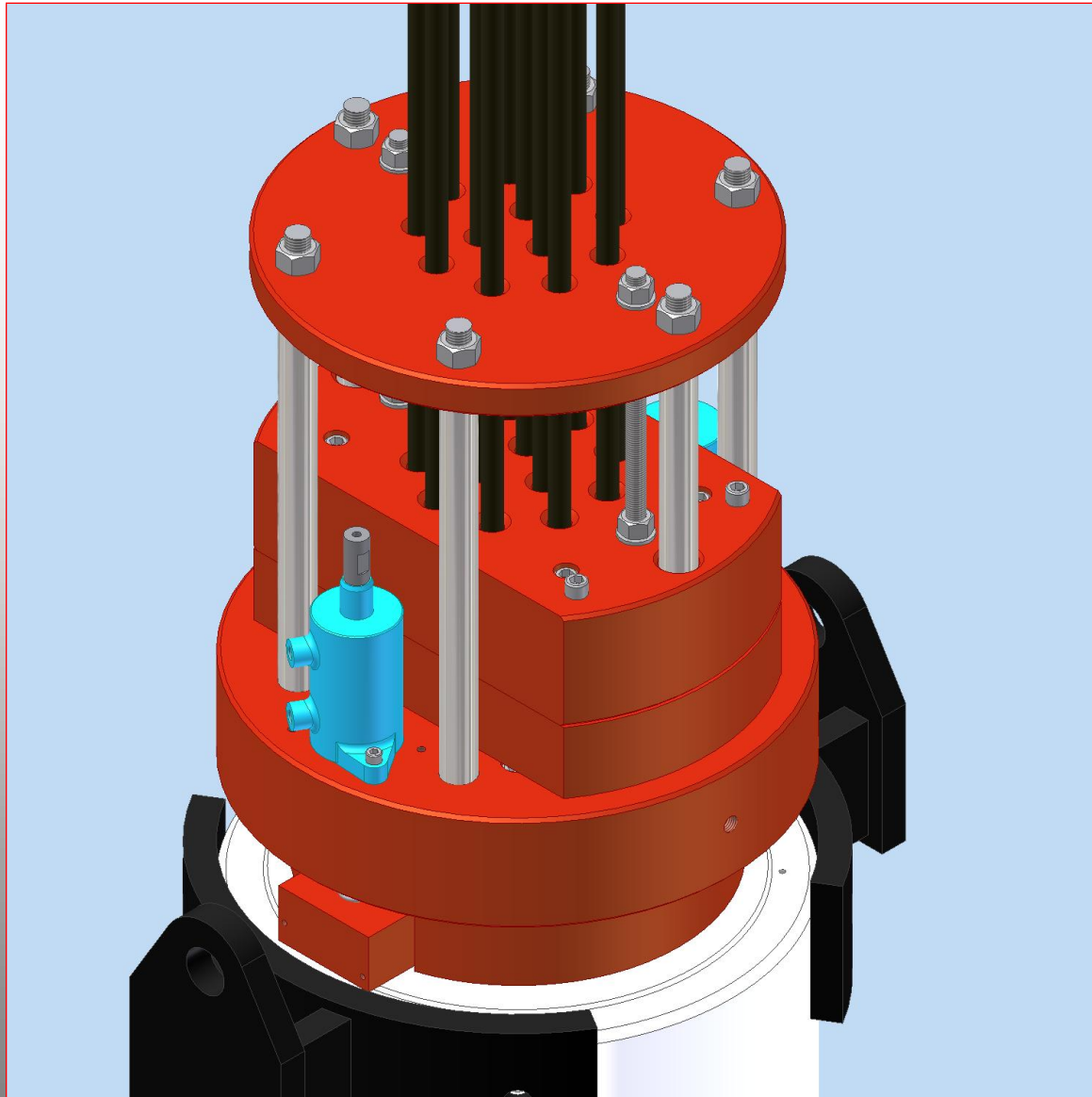

DL technology

General view of top anchor

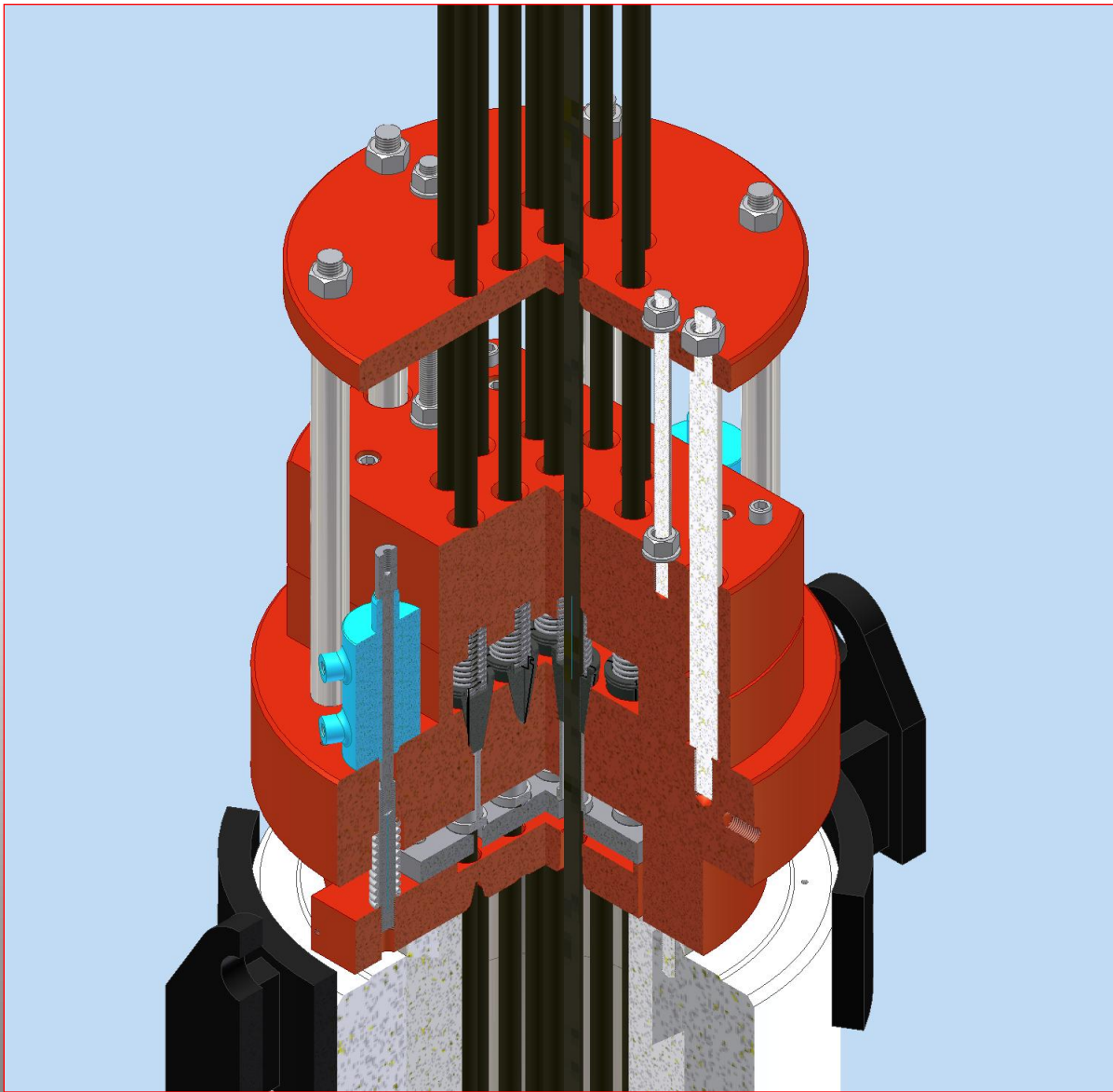

DL technology

Cut away of top anchor

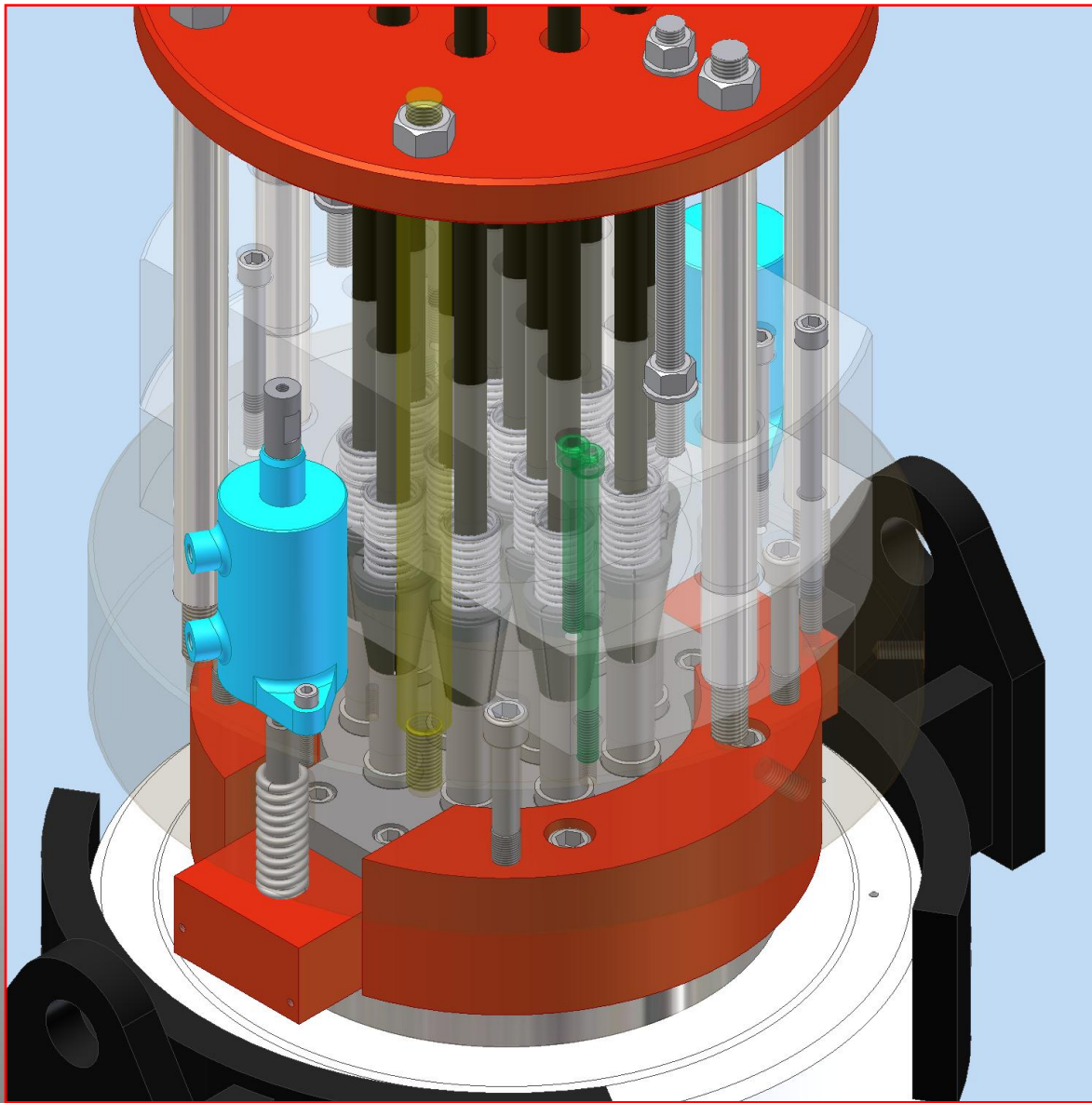

technology

Operation of top anchor - closed

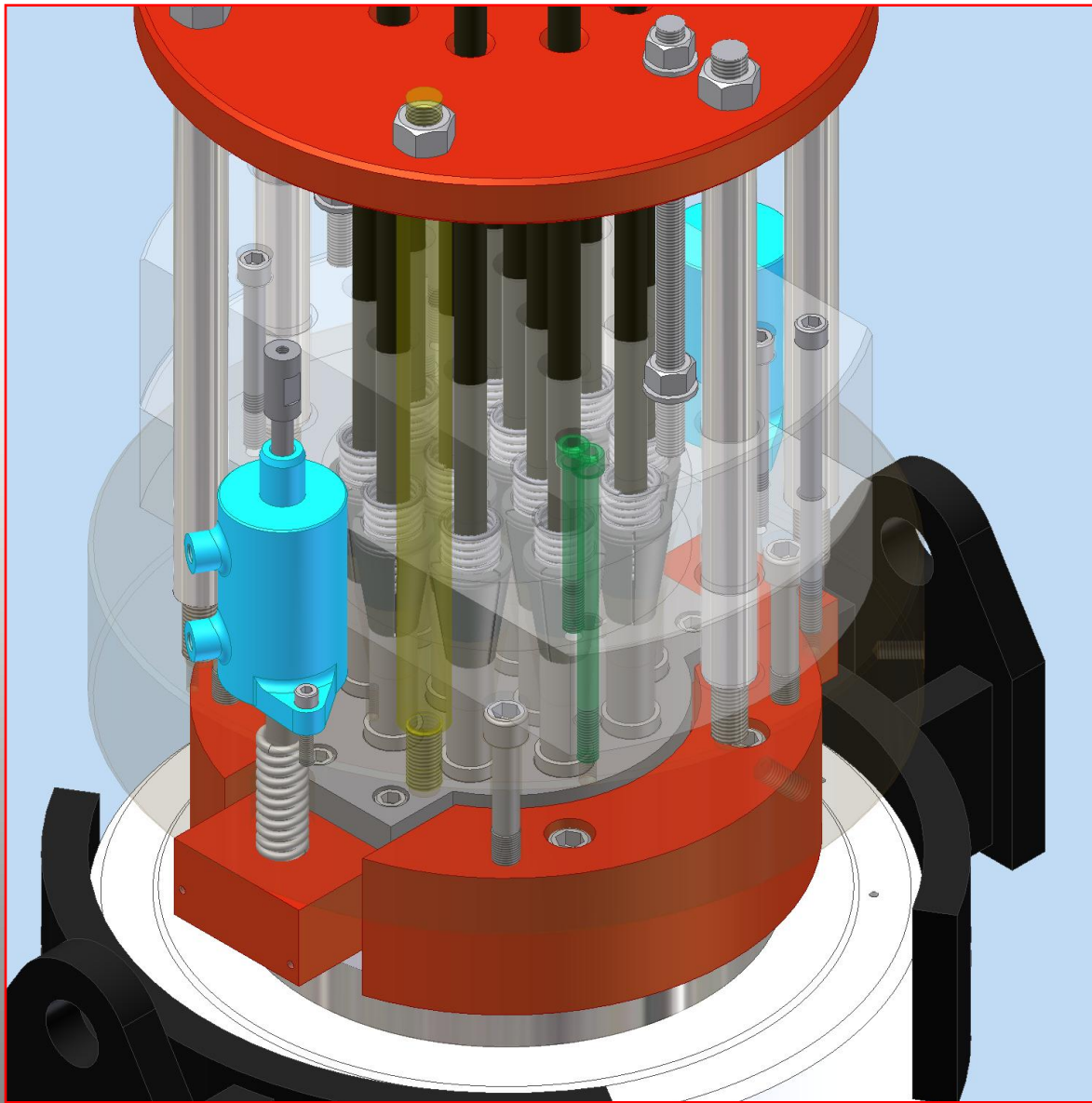

technology

Operation of top anchor - open

STRAND JACK

LOAD LIFTING SEQUENCE

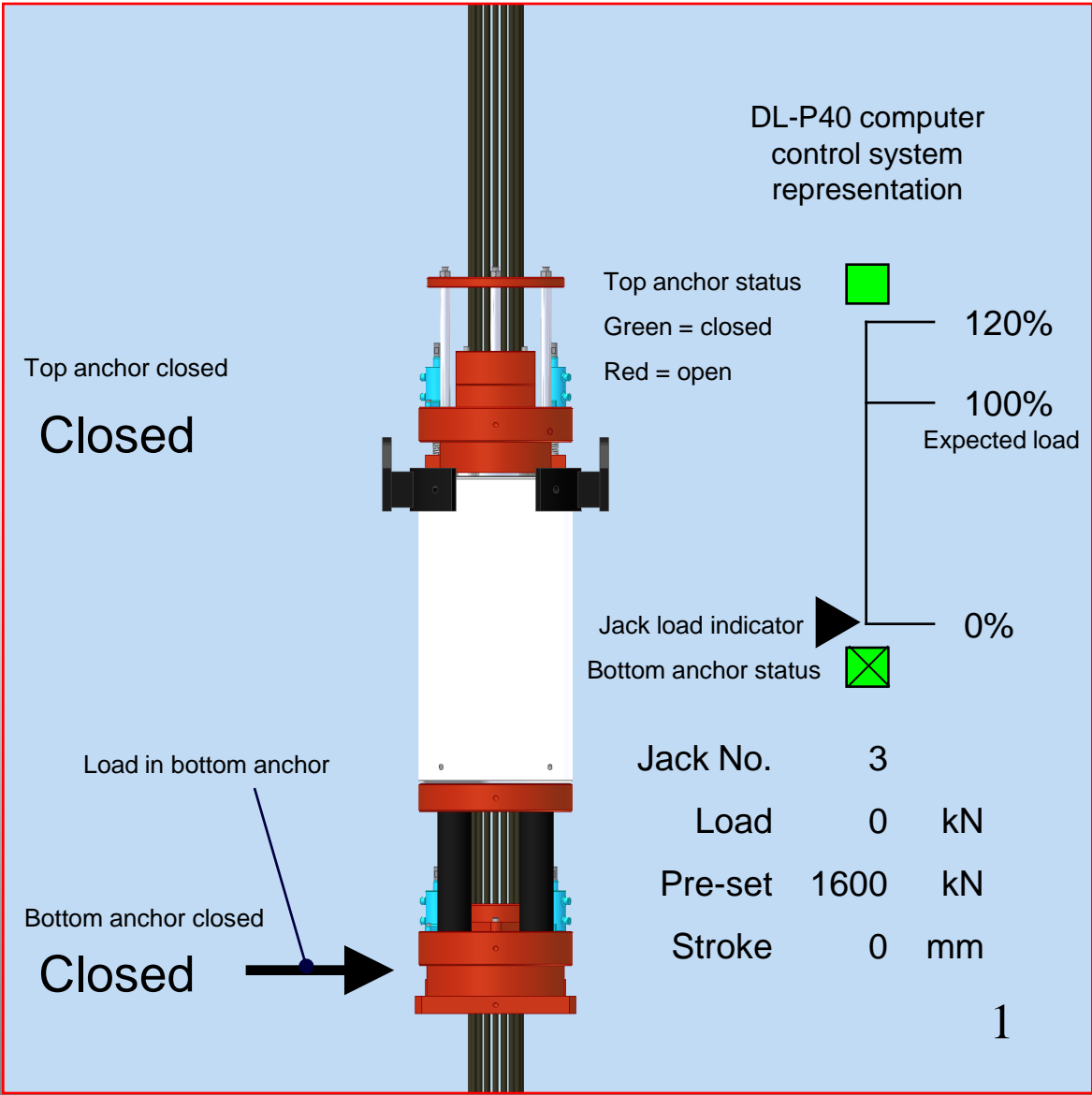

DL technology

Ready for strand lifting stroke

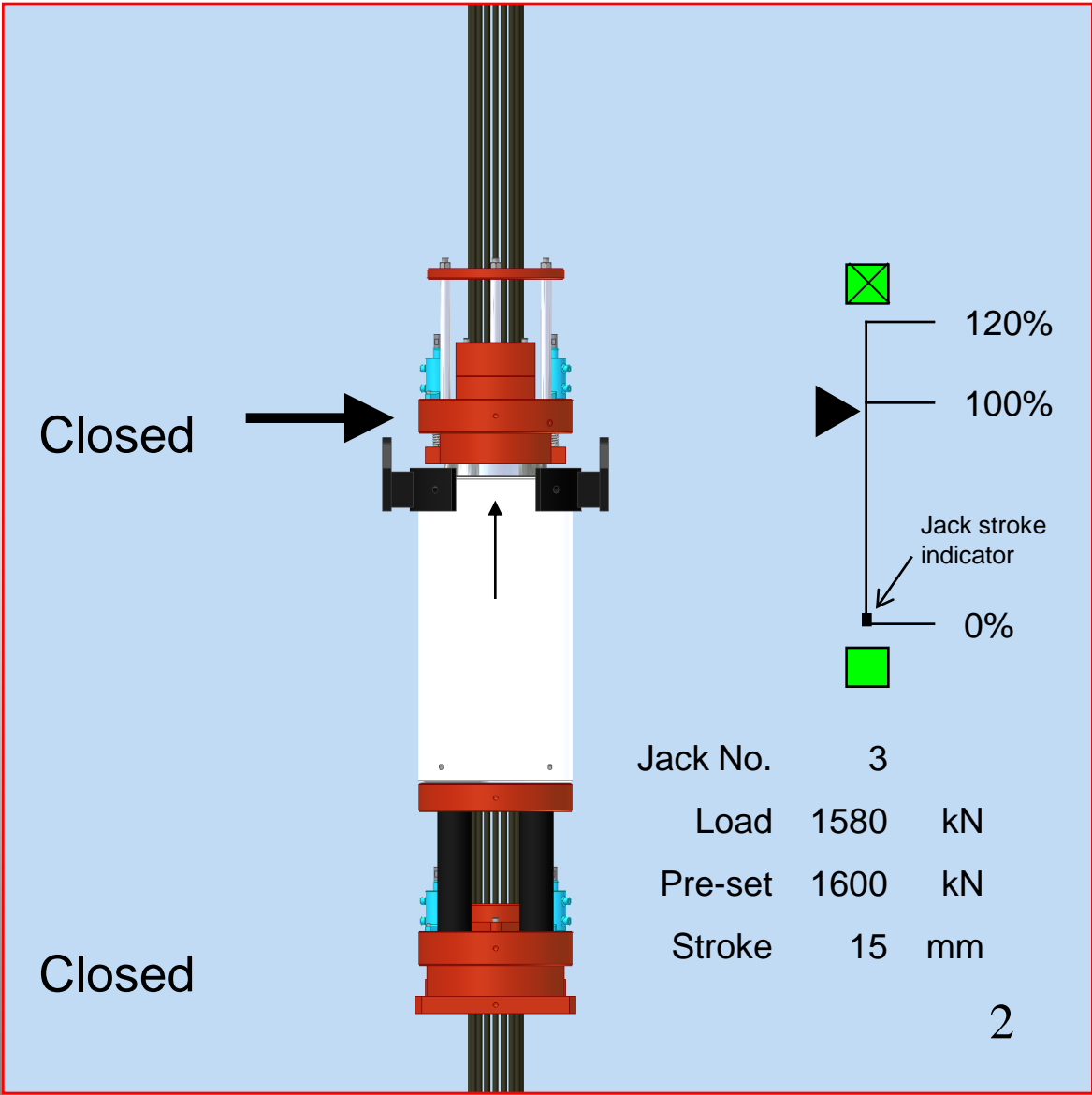

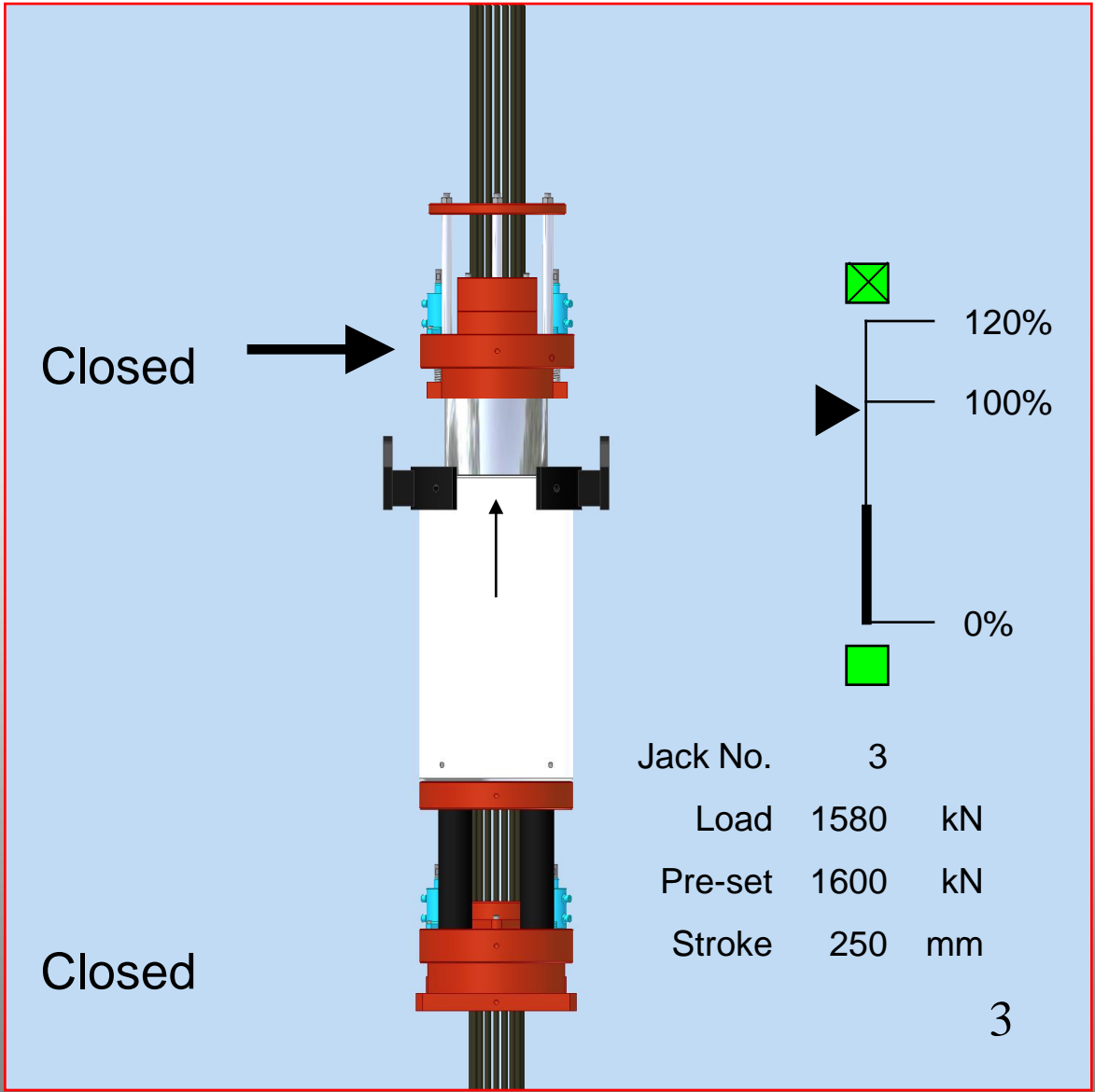

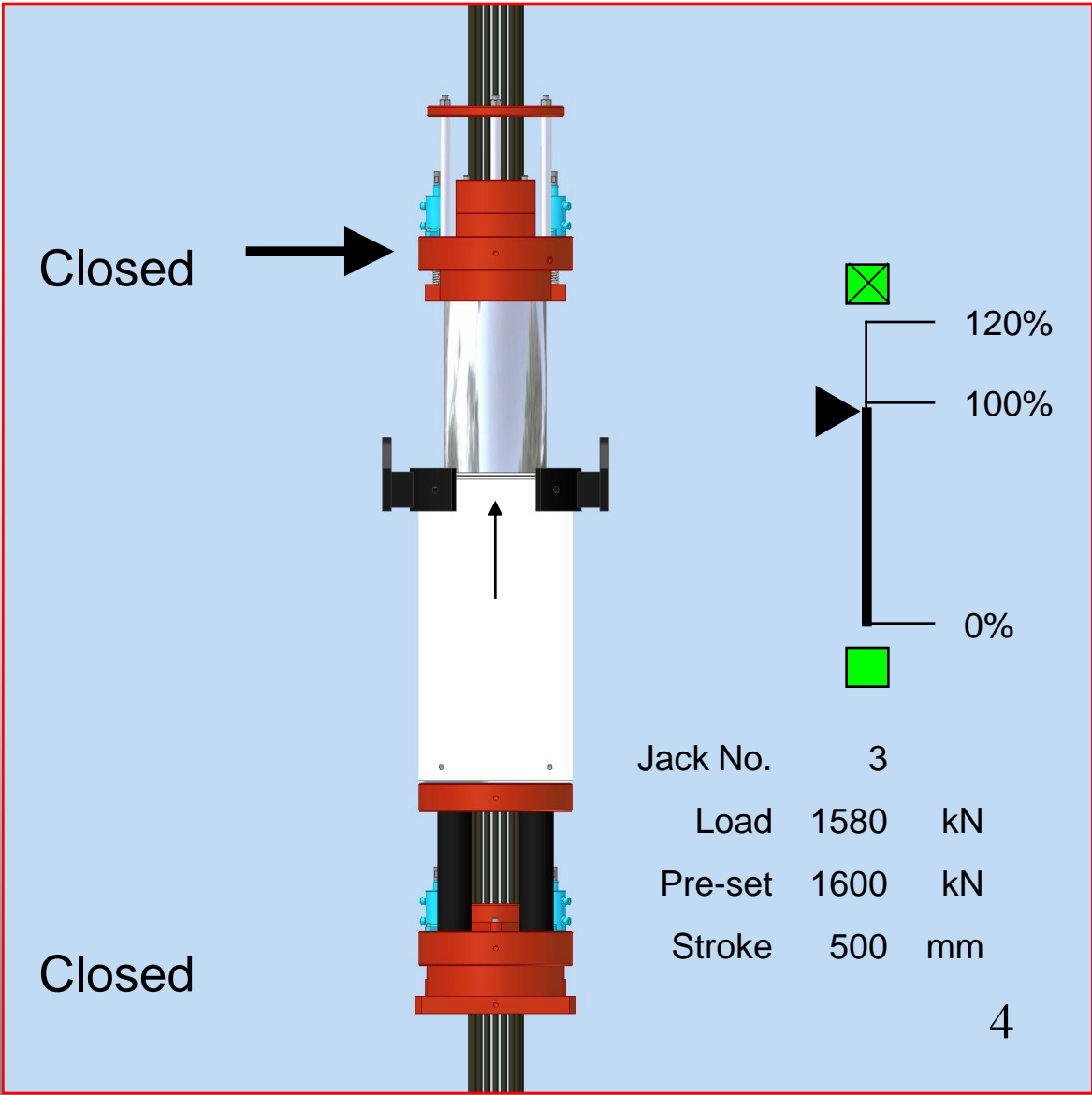

Closed

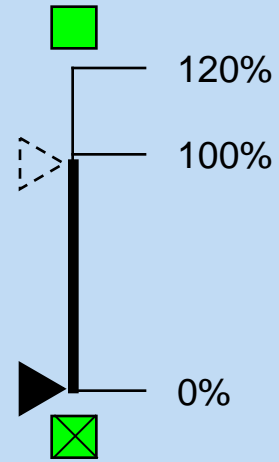
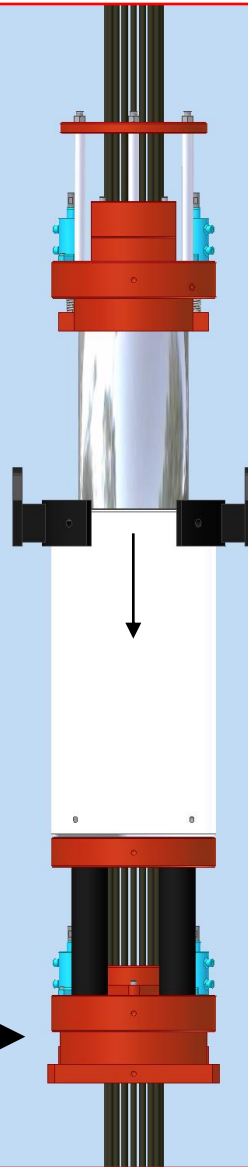

Jack No. 3
Load 1580 kN
Pre-set 1600 kN
Stroke 480 mm

5

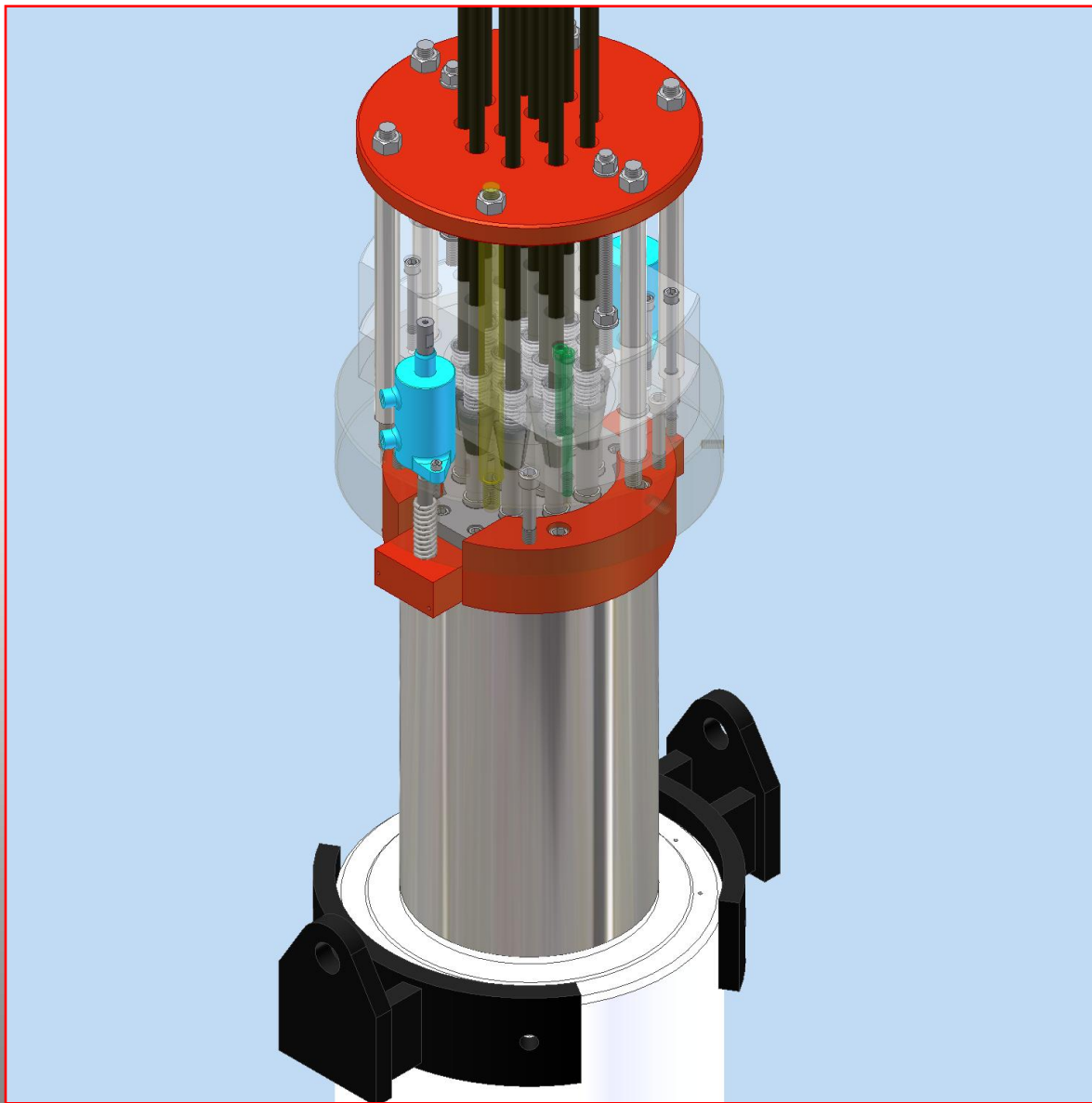

technology

Open top anchor

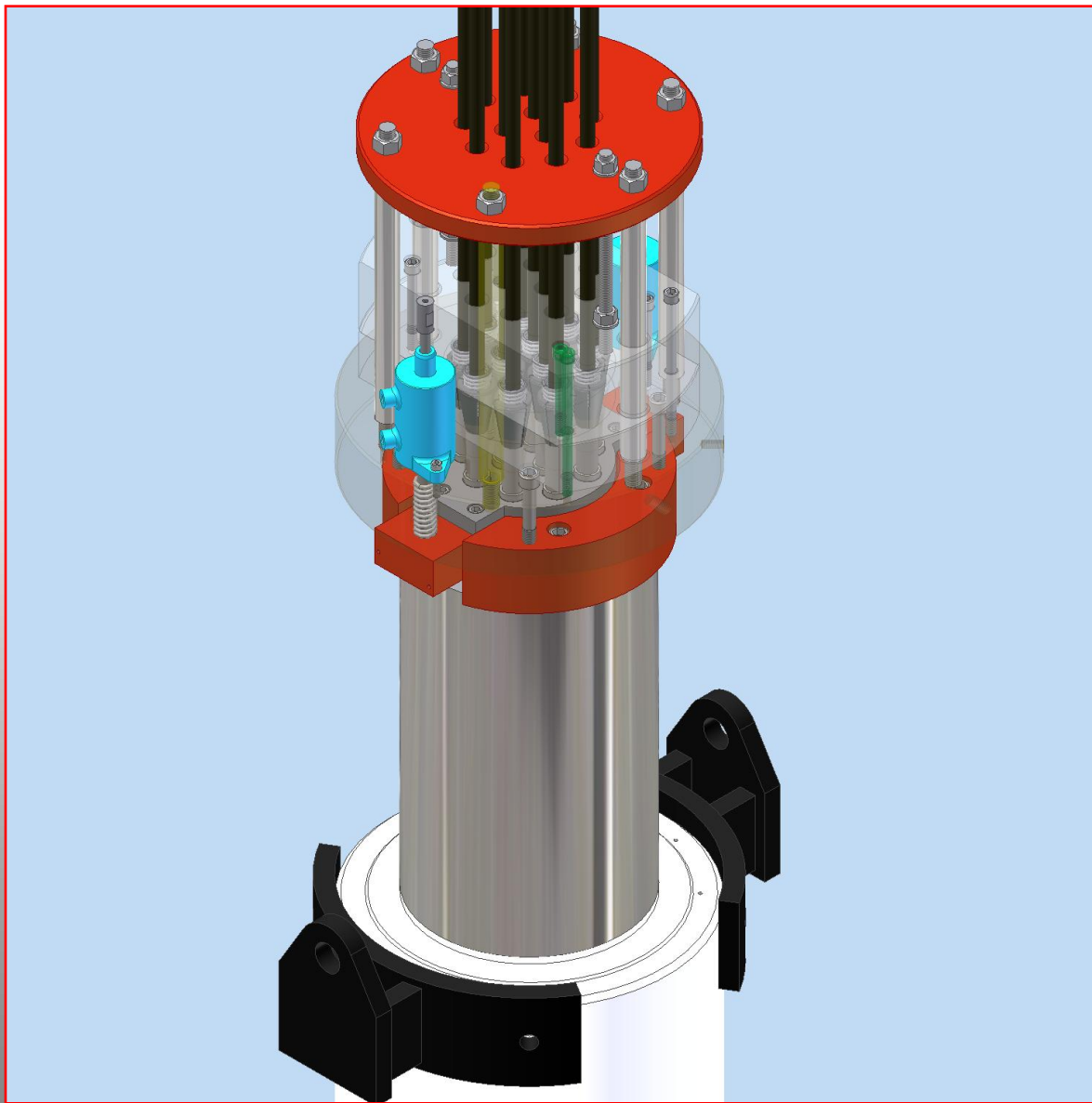

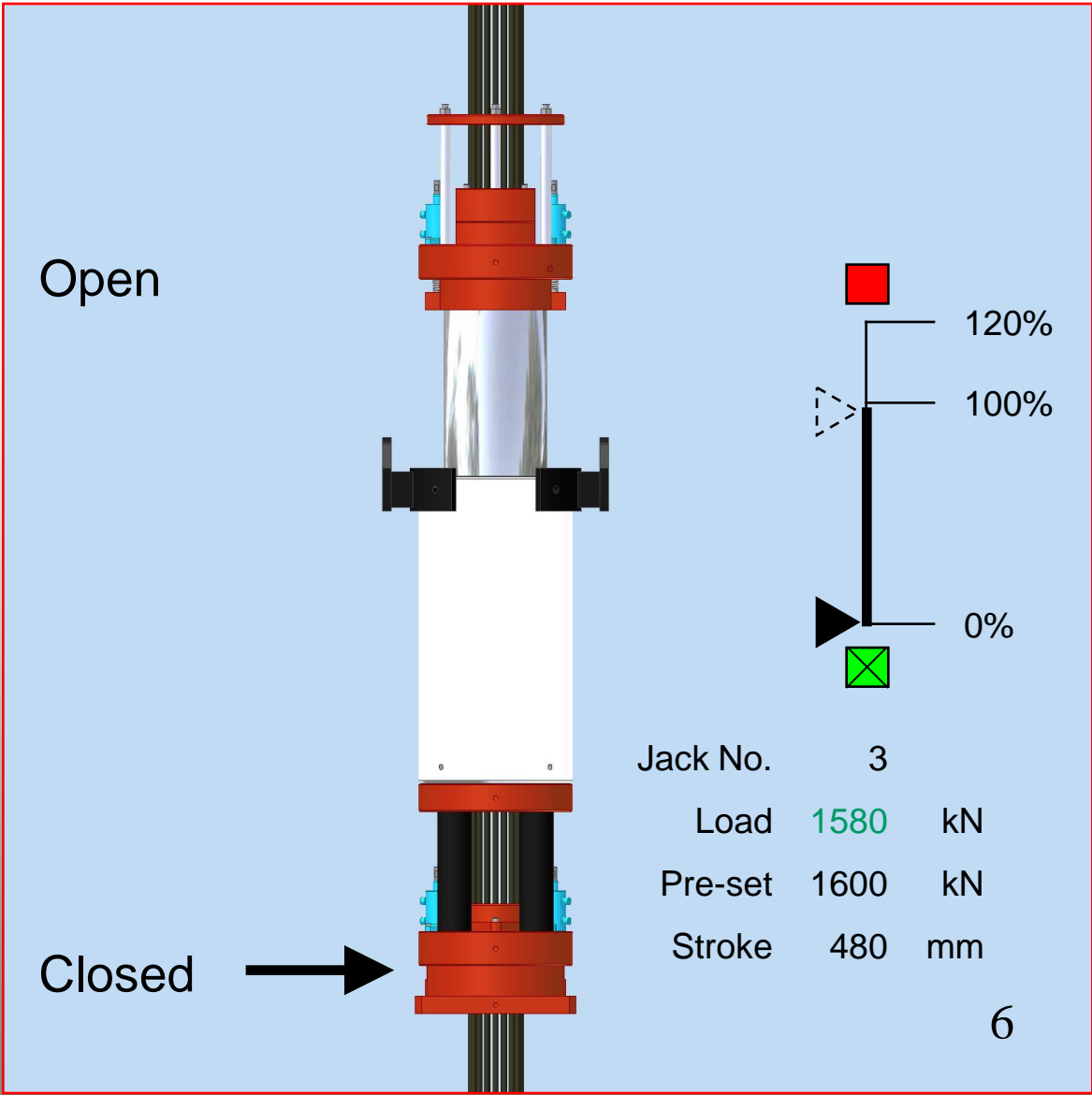

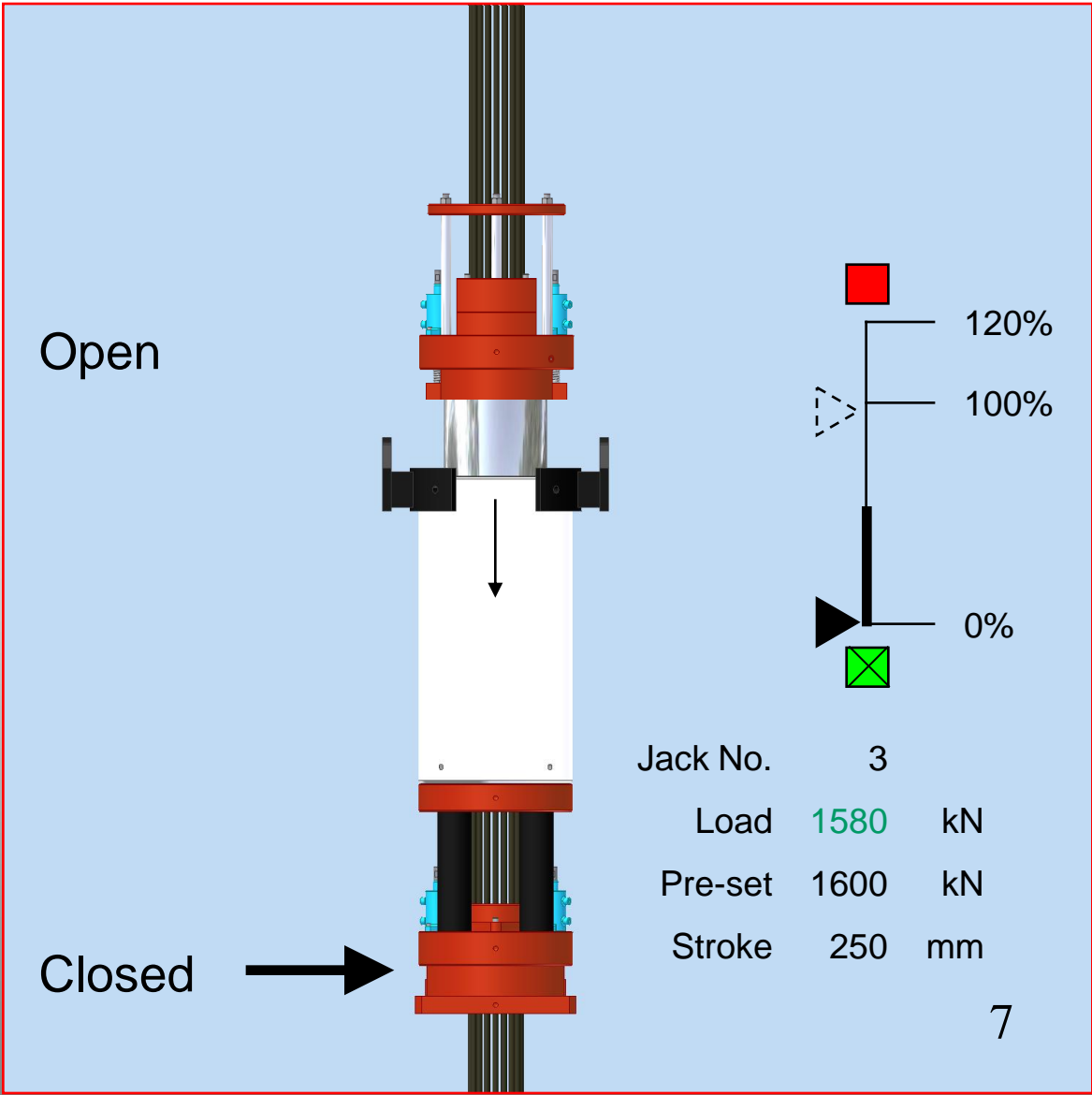

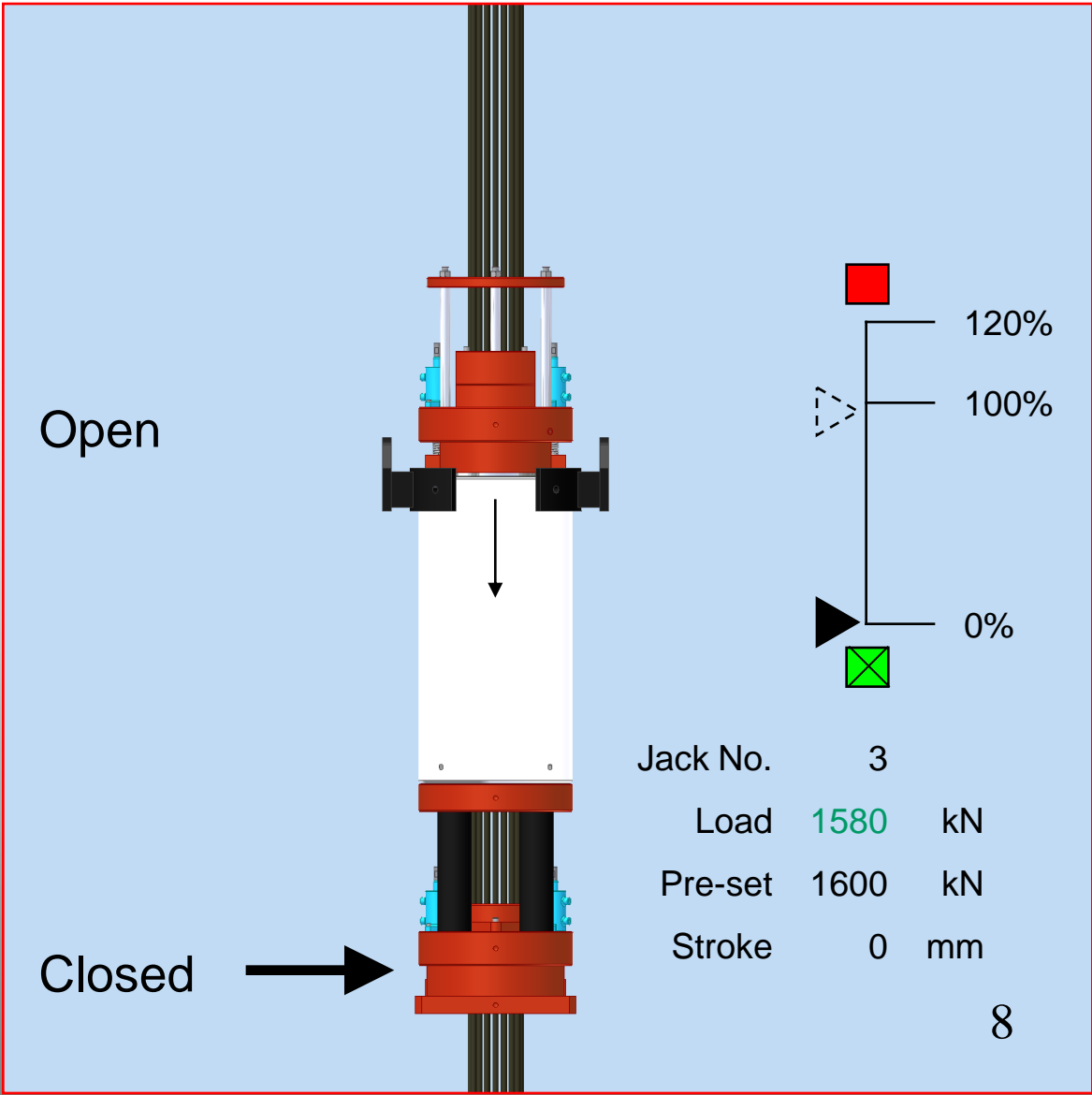

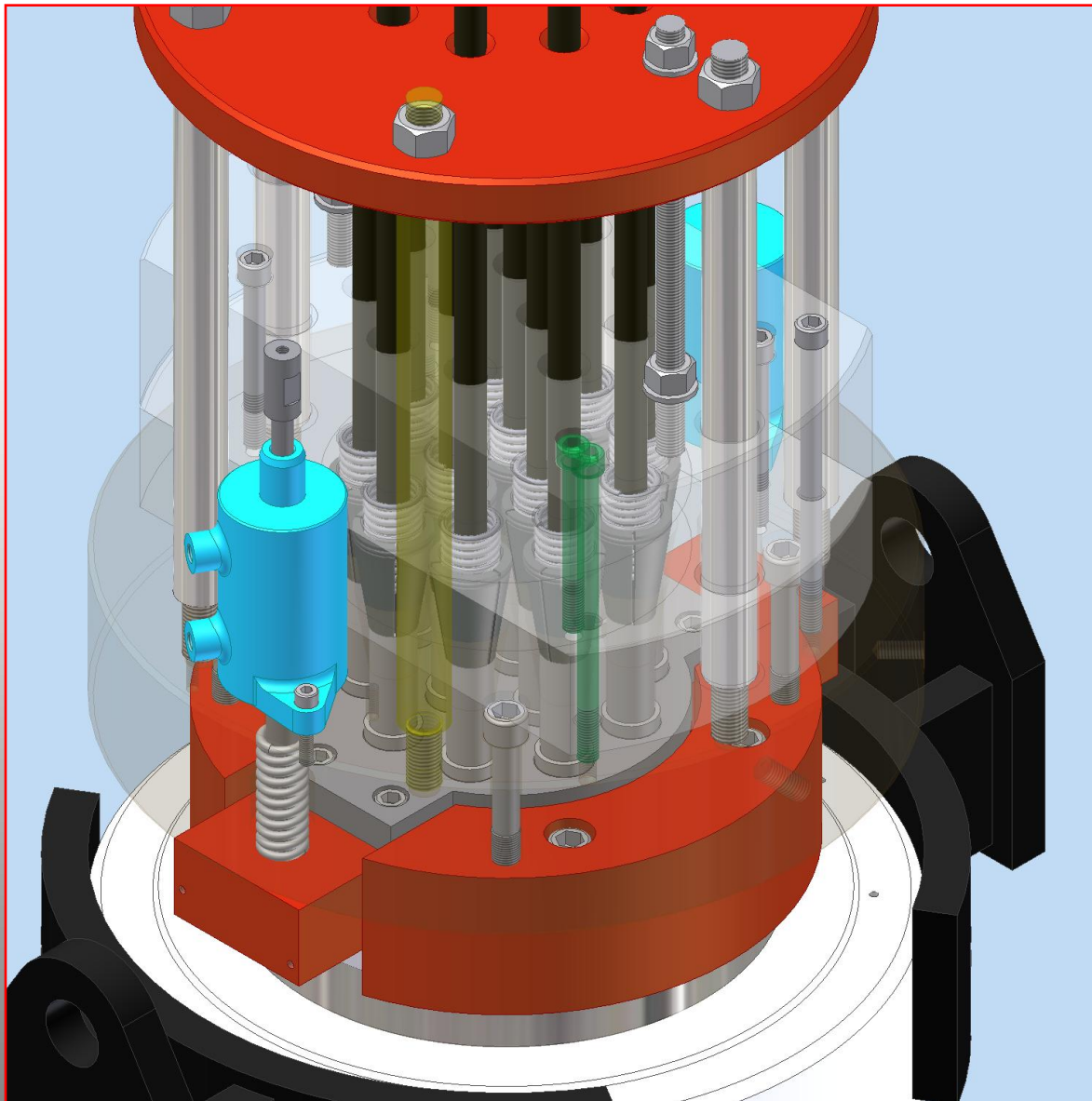

technology

Close top anchor

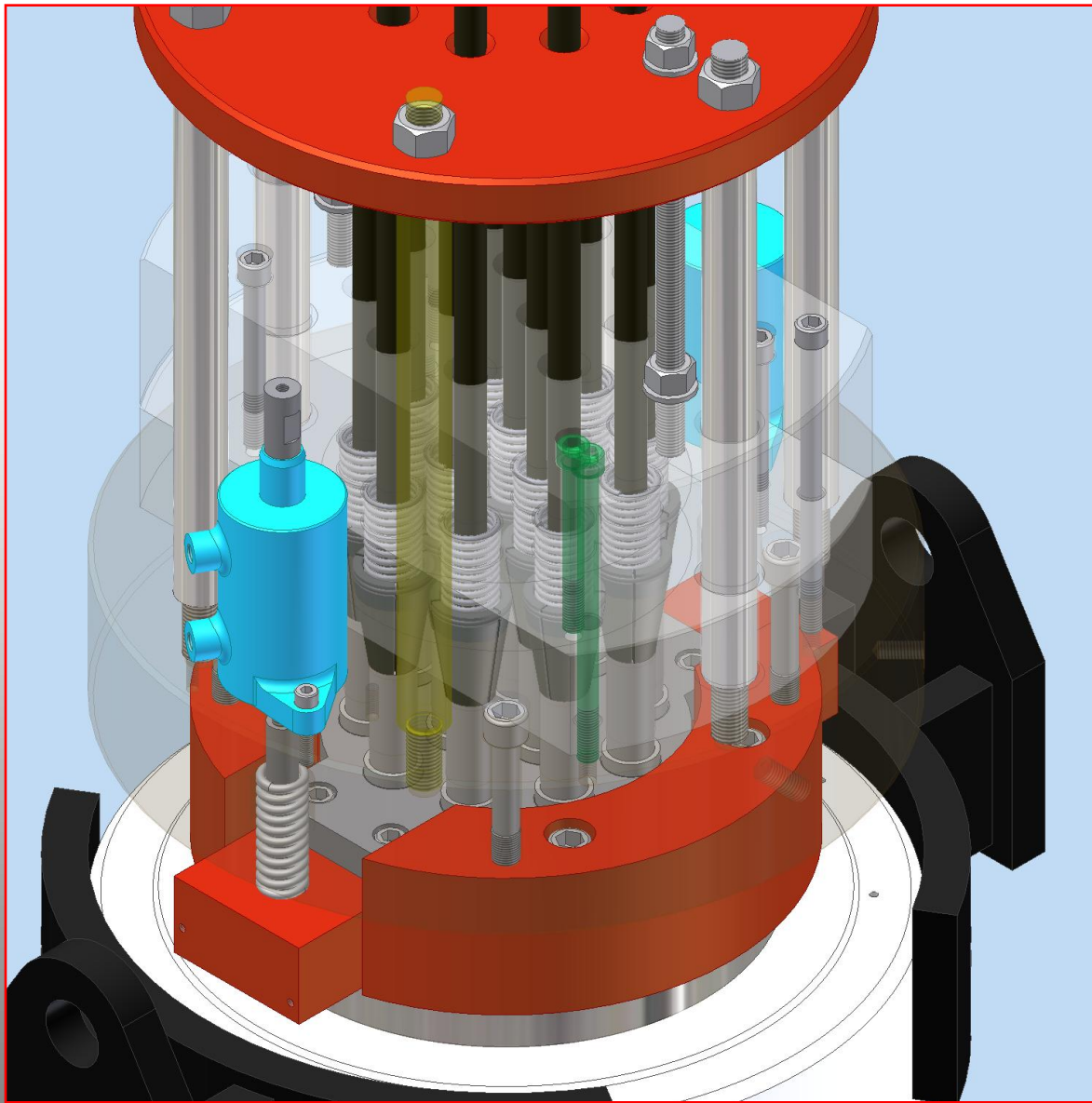

technology

Close top anchor

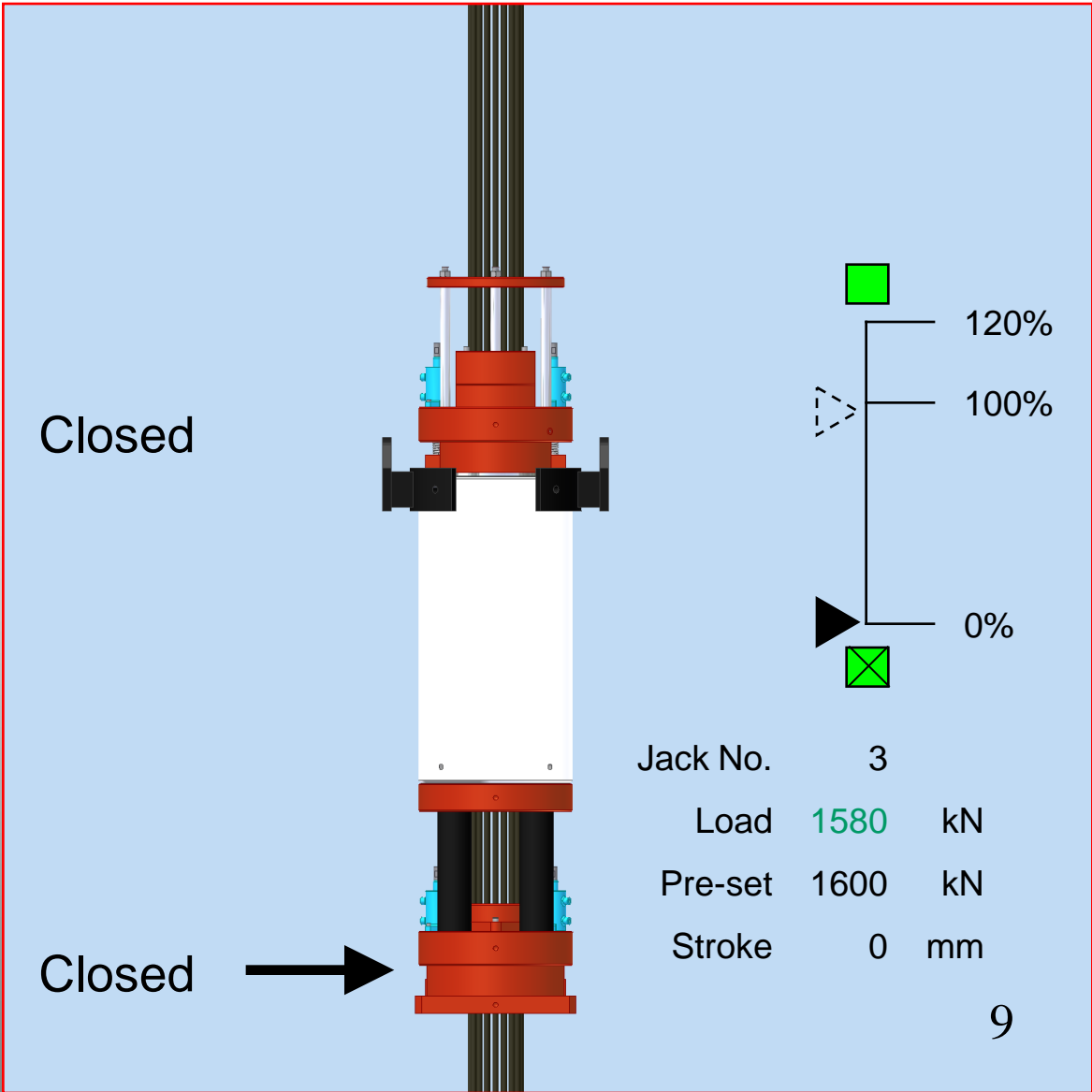

[Back](#)

**STRAND JACK
LOAD LOWERING
SEQUENCE**

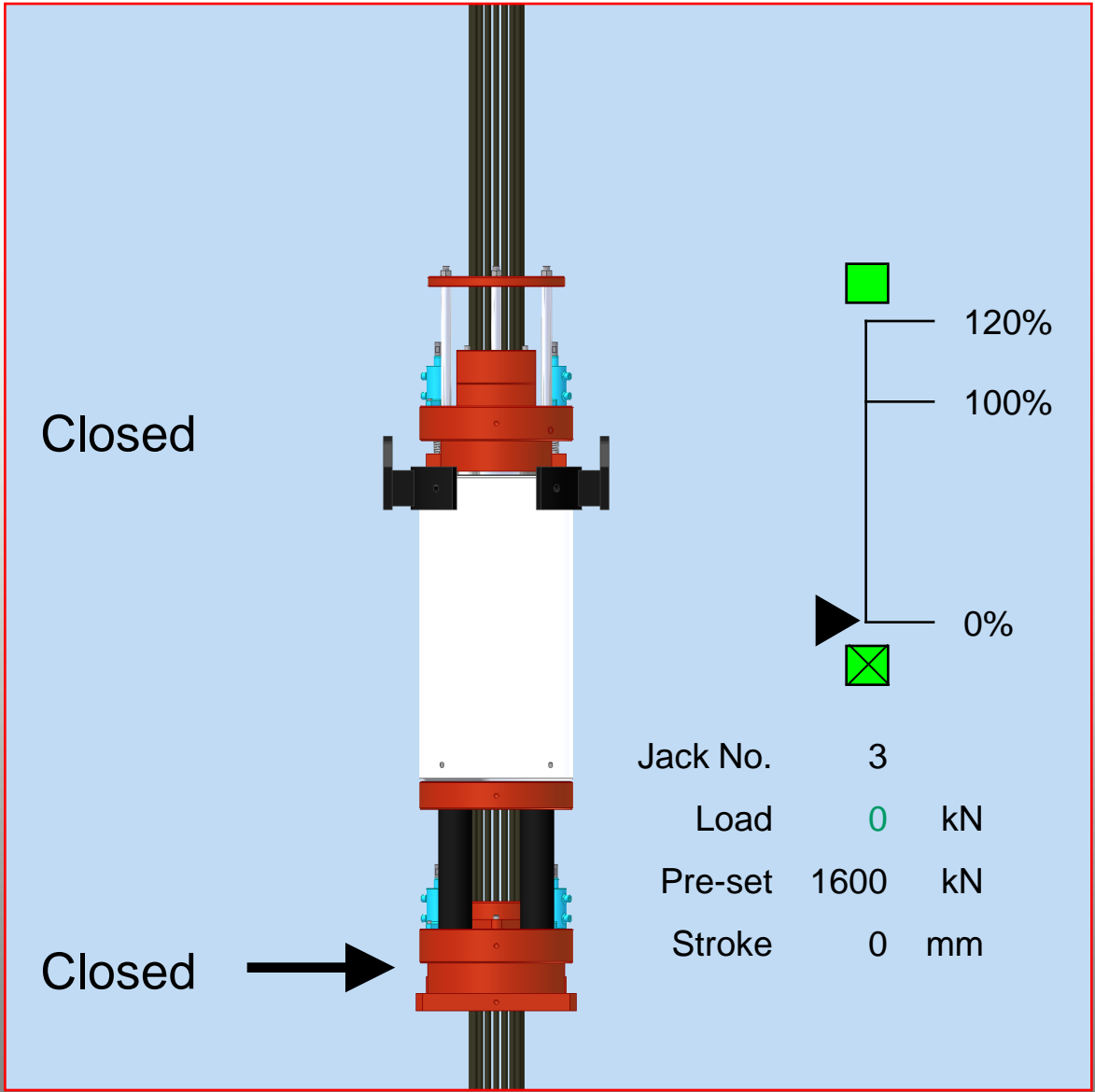

DL technology

Jack fully retracted with grips closed

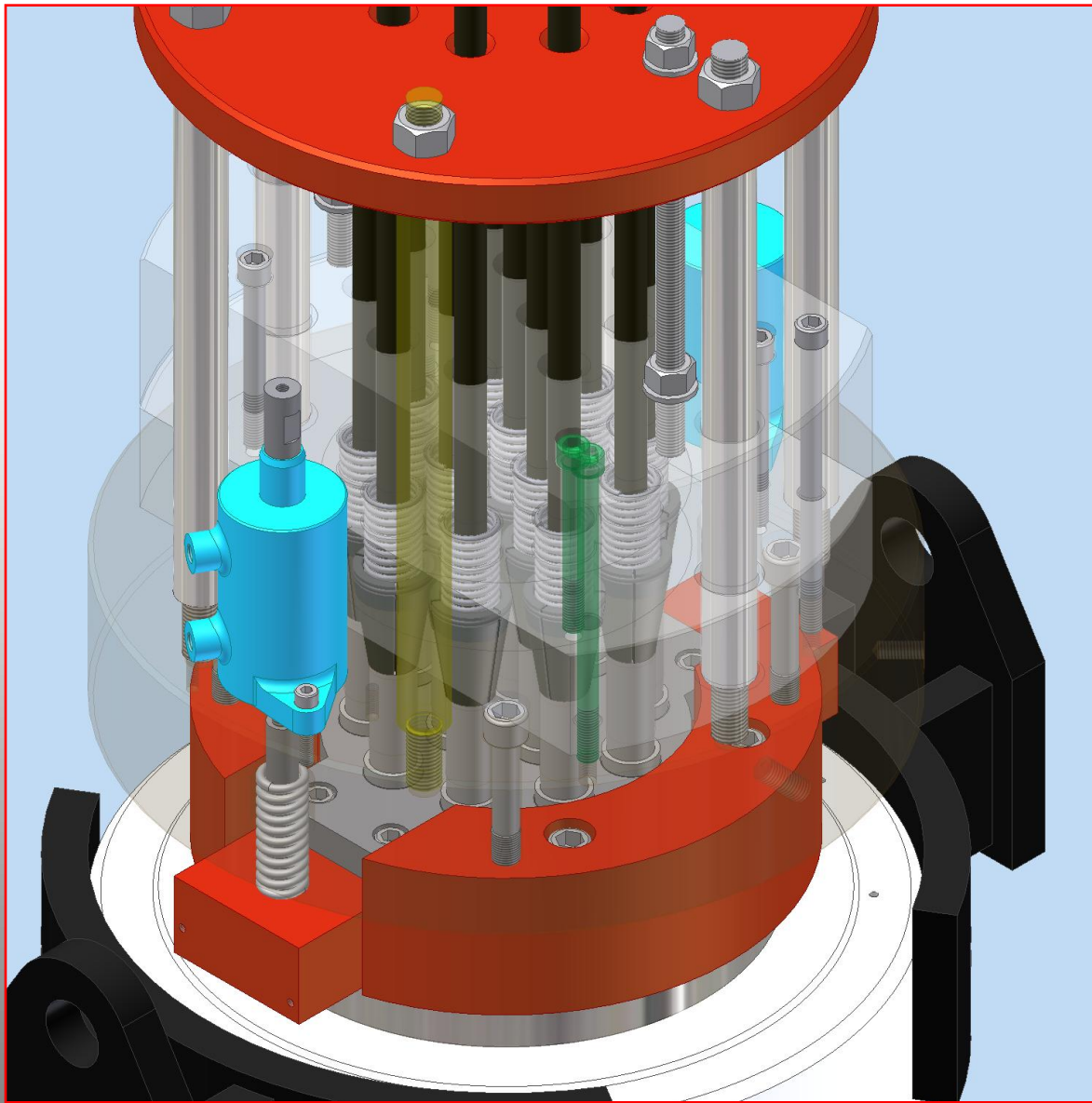

technology

Open top anchor

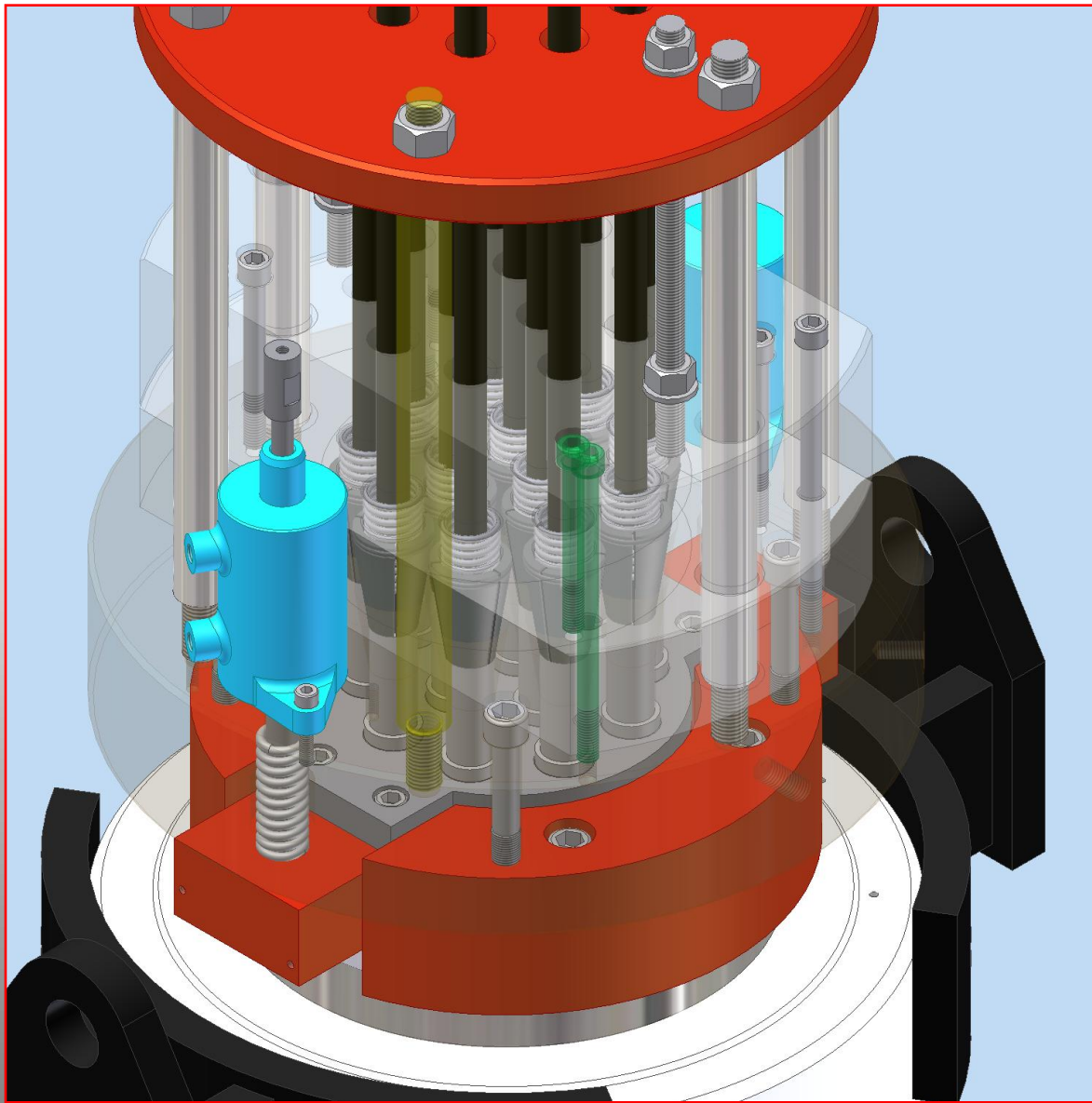

technology

Open top anchor

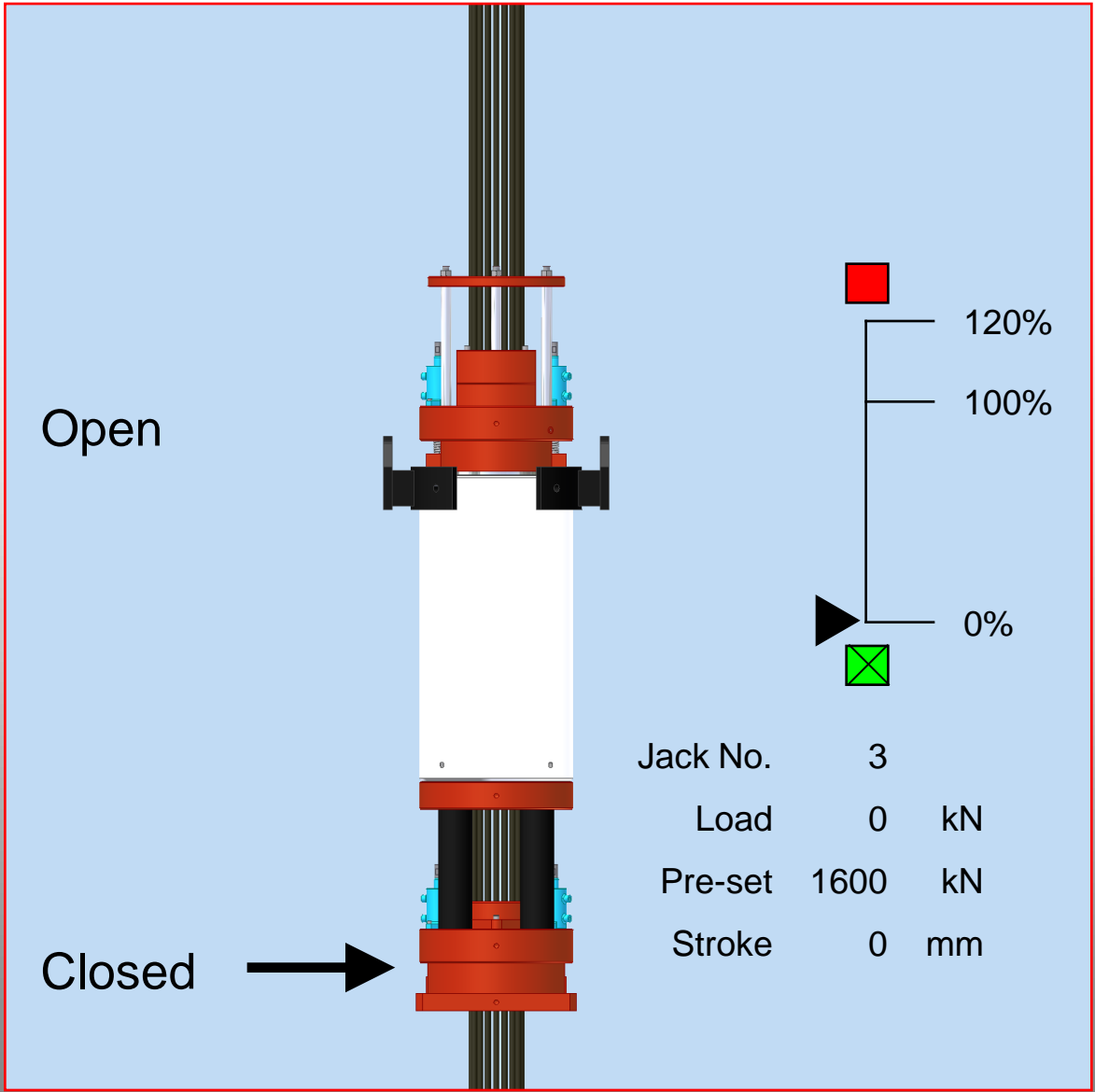

DL technology

Ready for ram extend stroke

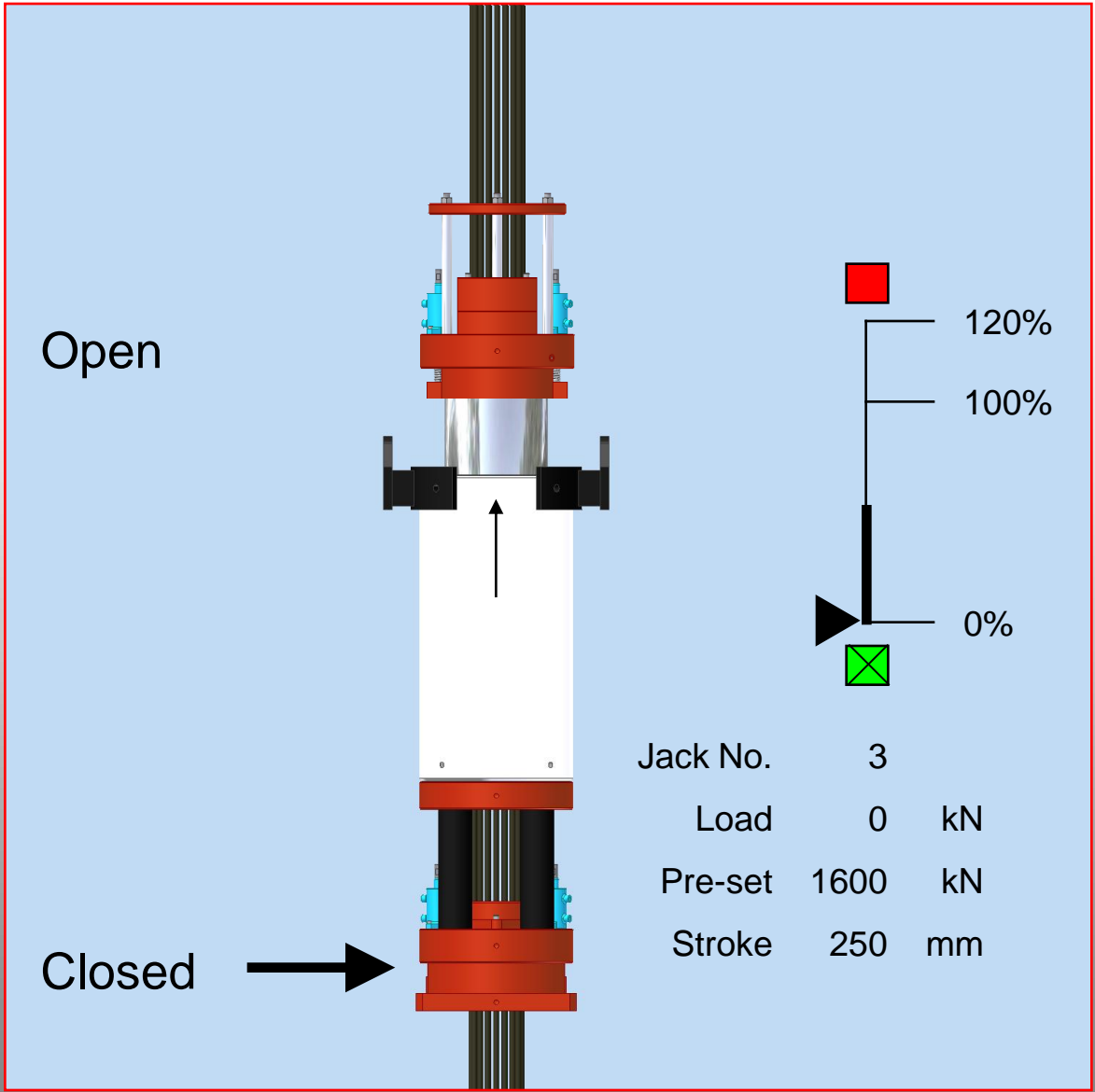

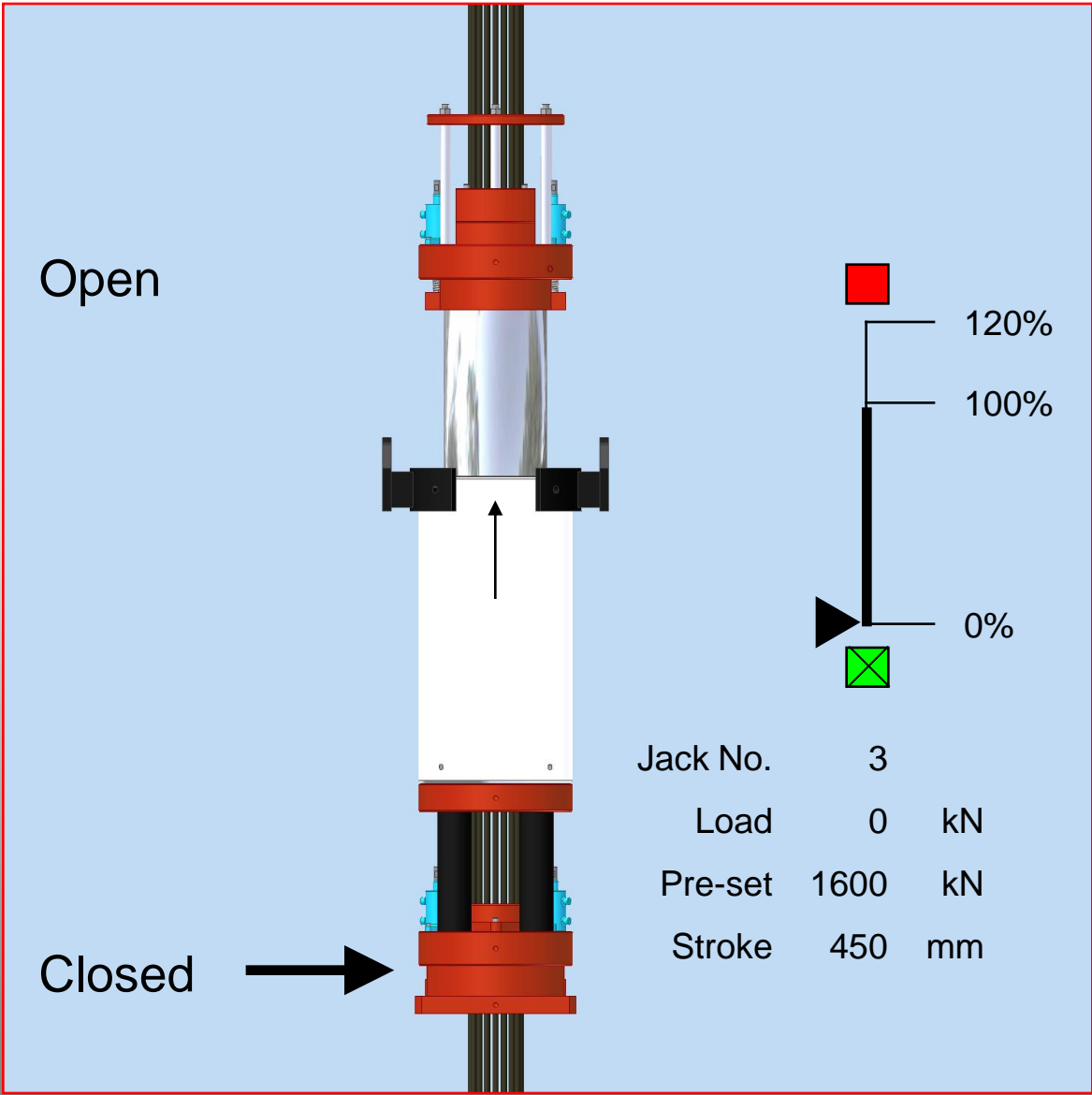

DL technology

Top of ram extend stroke

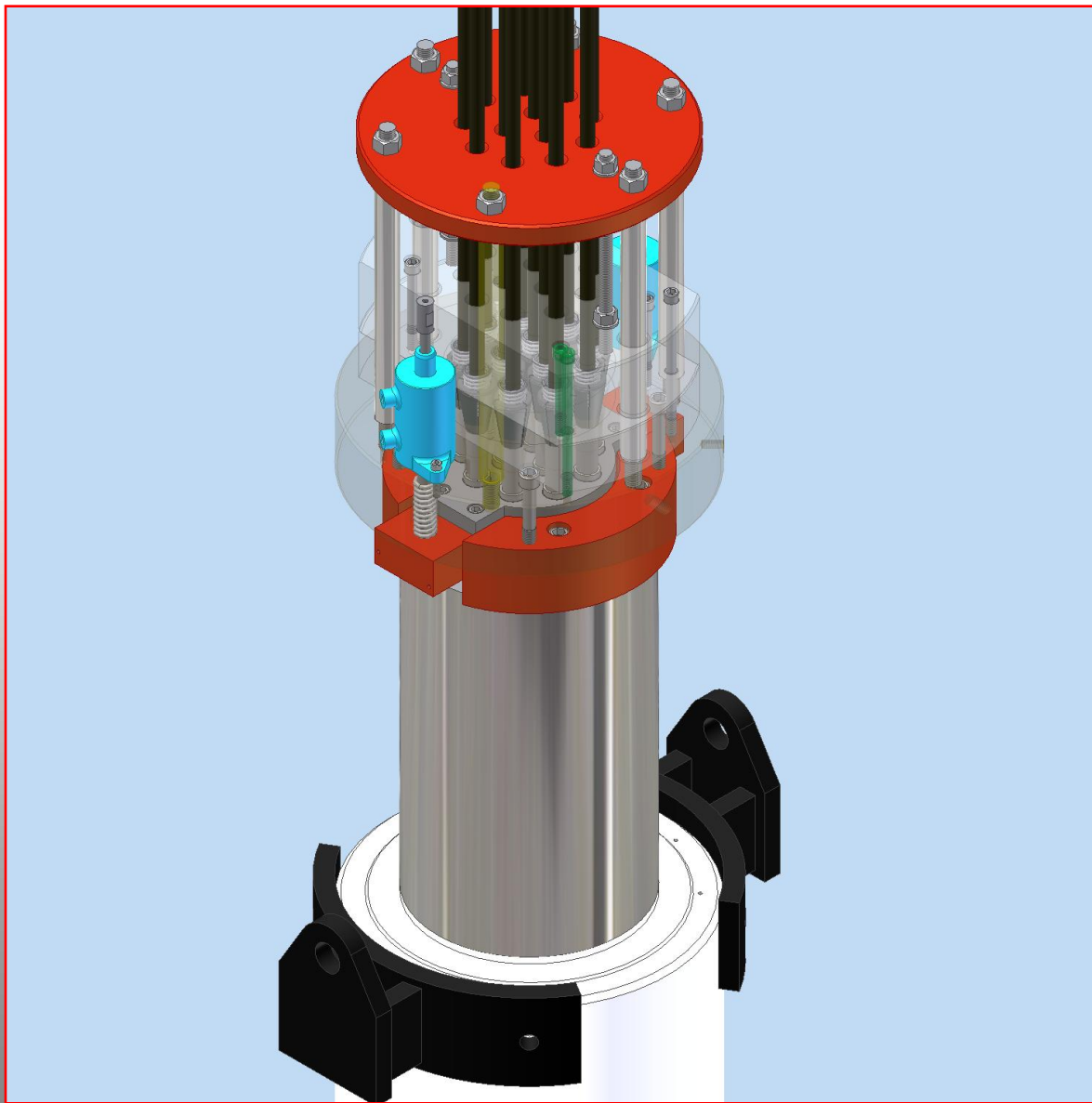

DL technology

Close top anchor

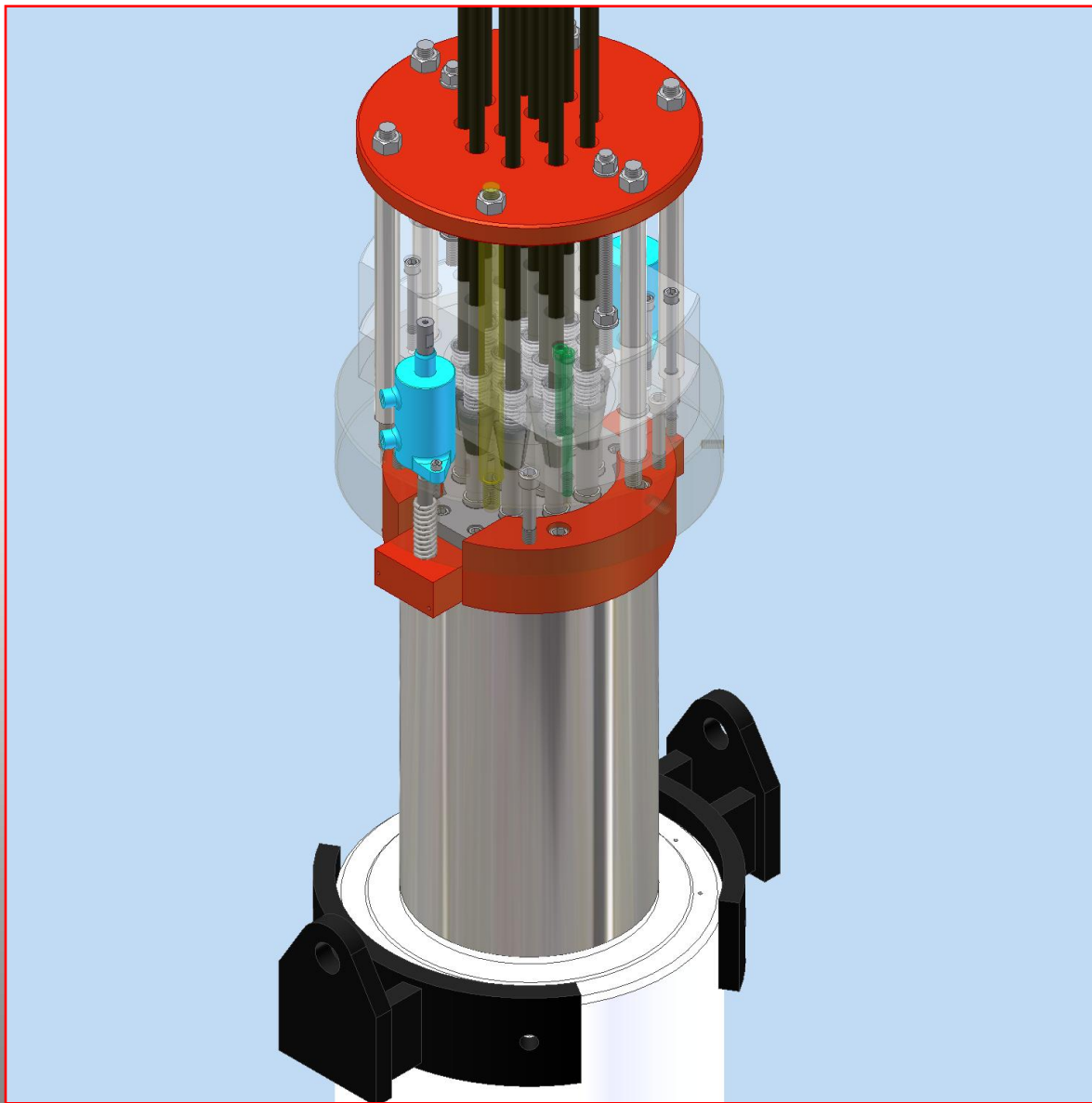

Closed

Closed

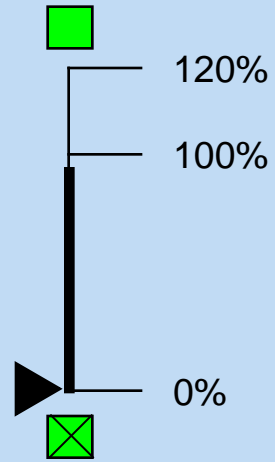
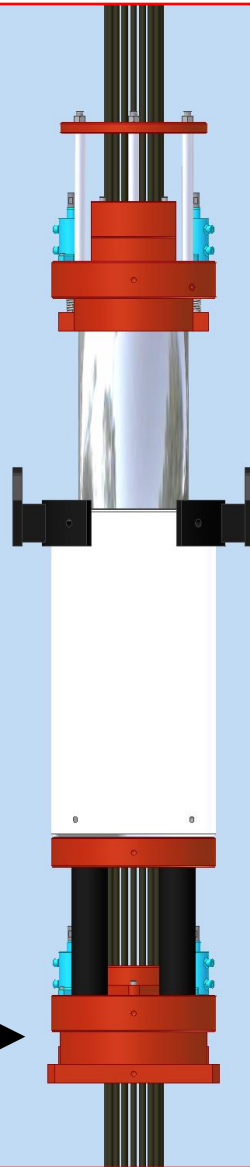

Jack No.	3
Load	0 kN
Pre-set	1600 kN
Stroke	450 mm

1

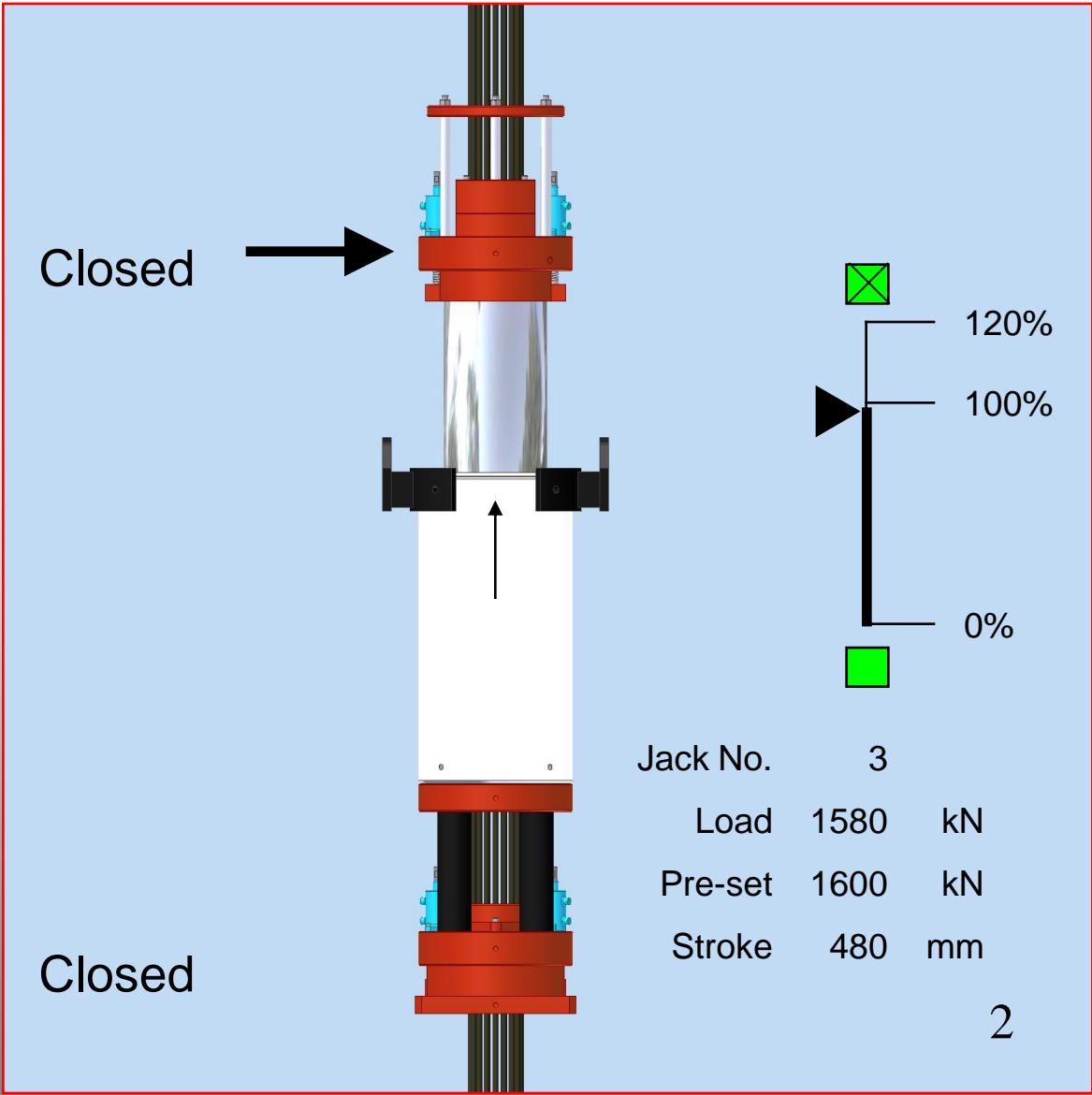

DL technology

Extend ram to transfer load to top anchor

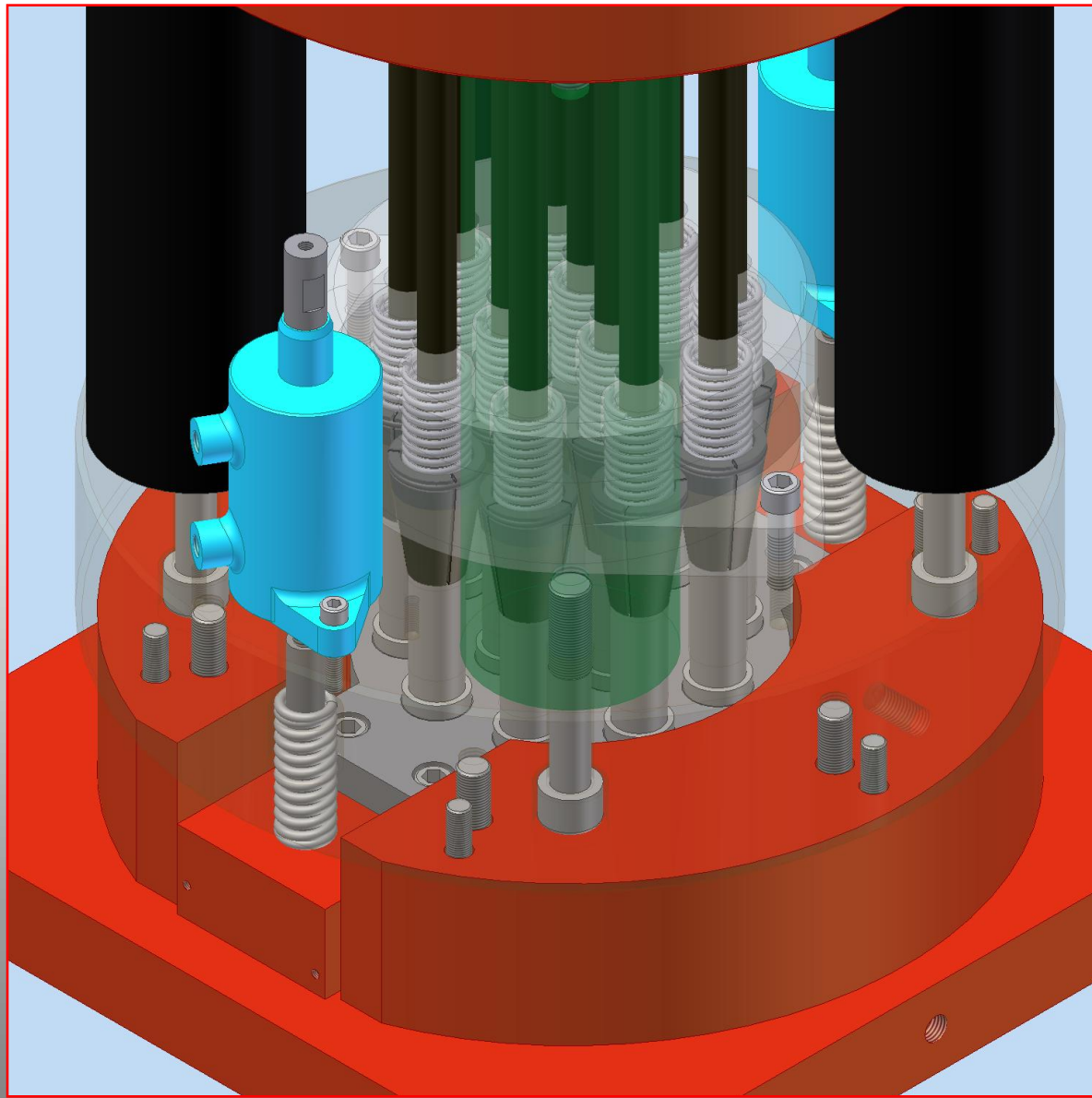

technology

Open bottom anchor

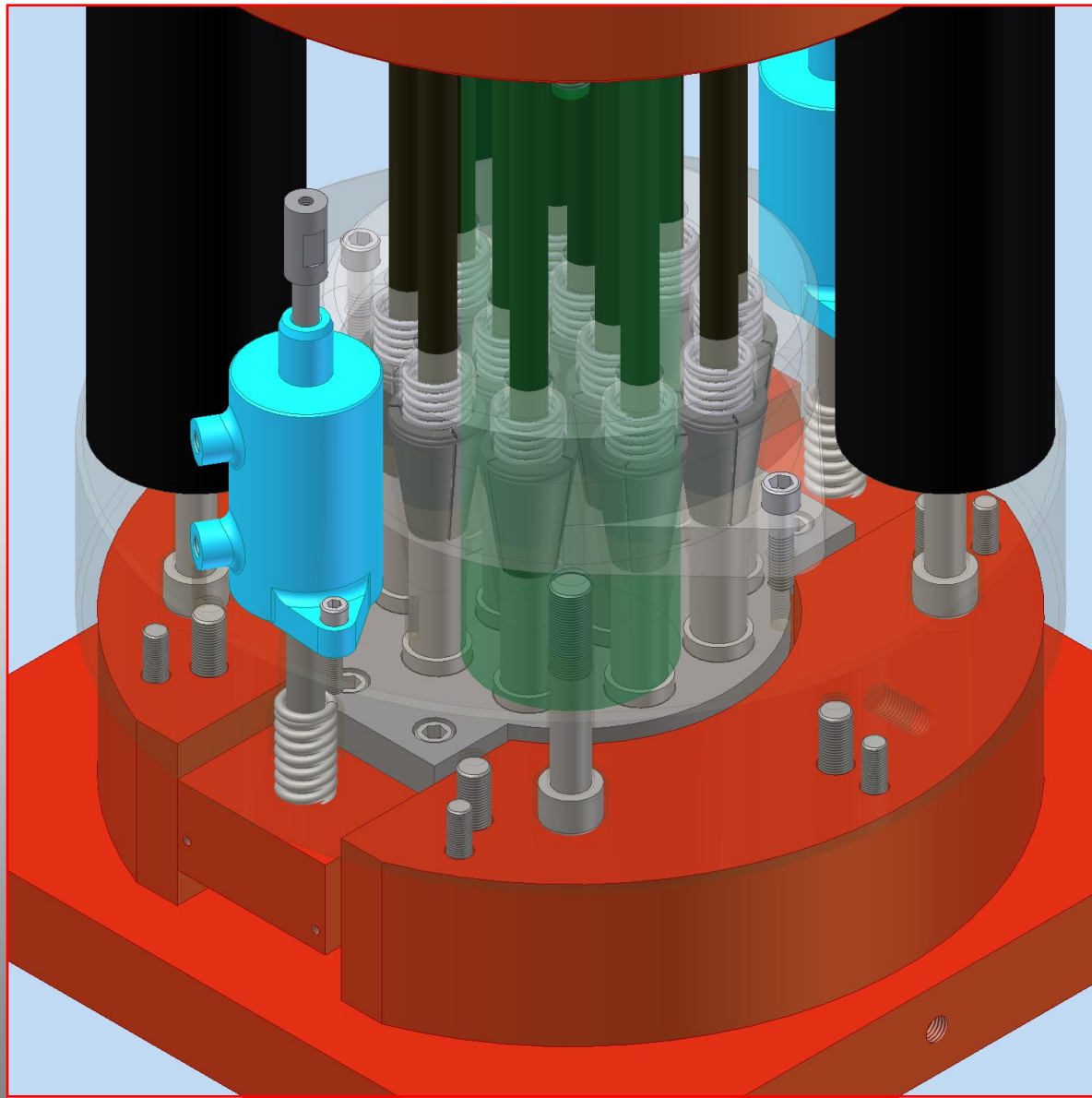

technology

Open bottom anchor

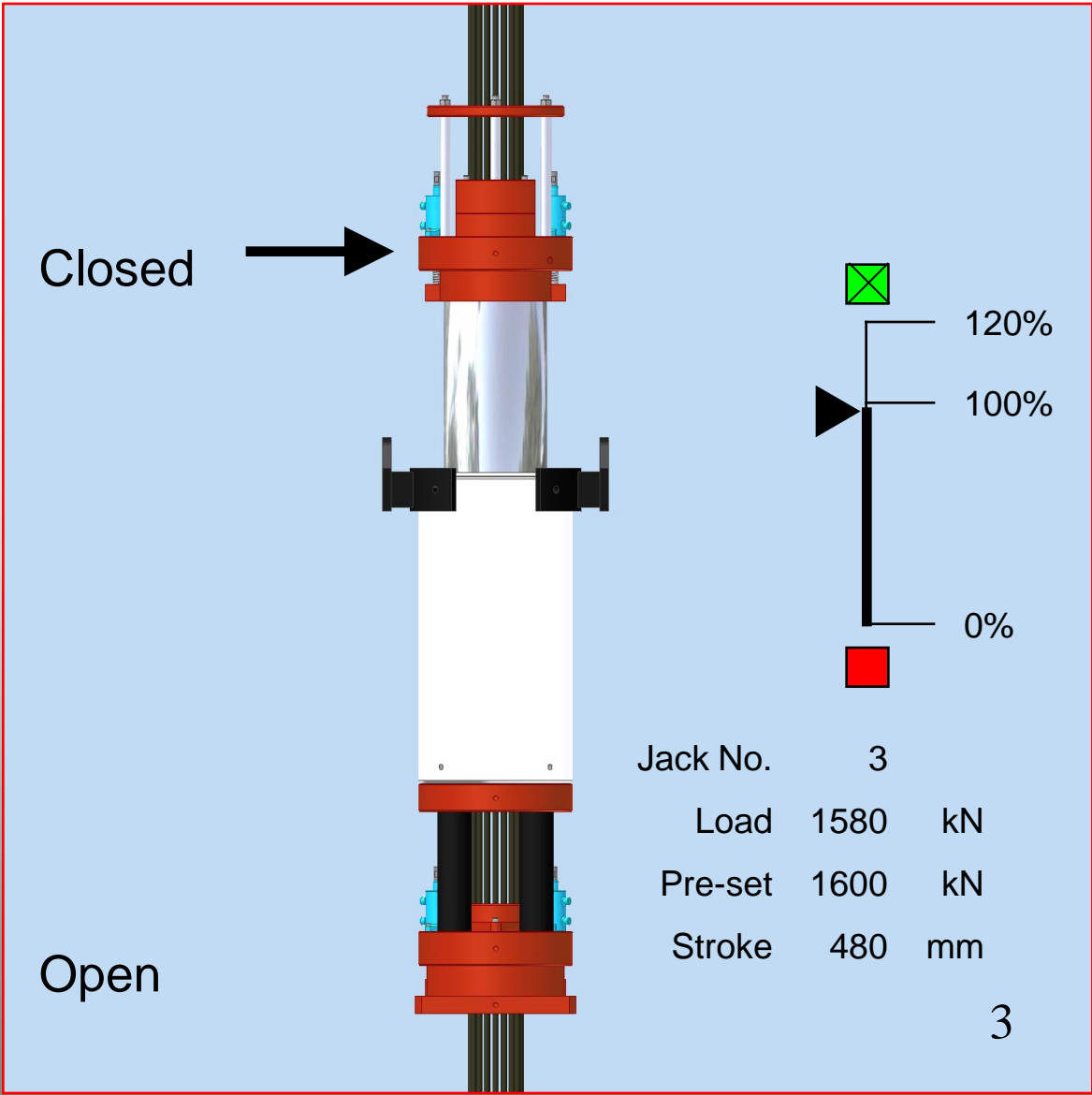

DL technology

Ready for strand lowering stroke

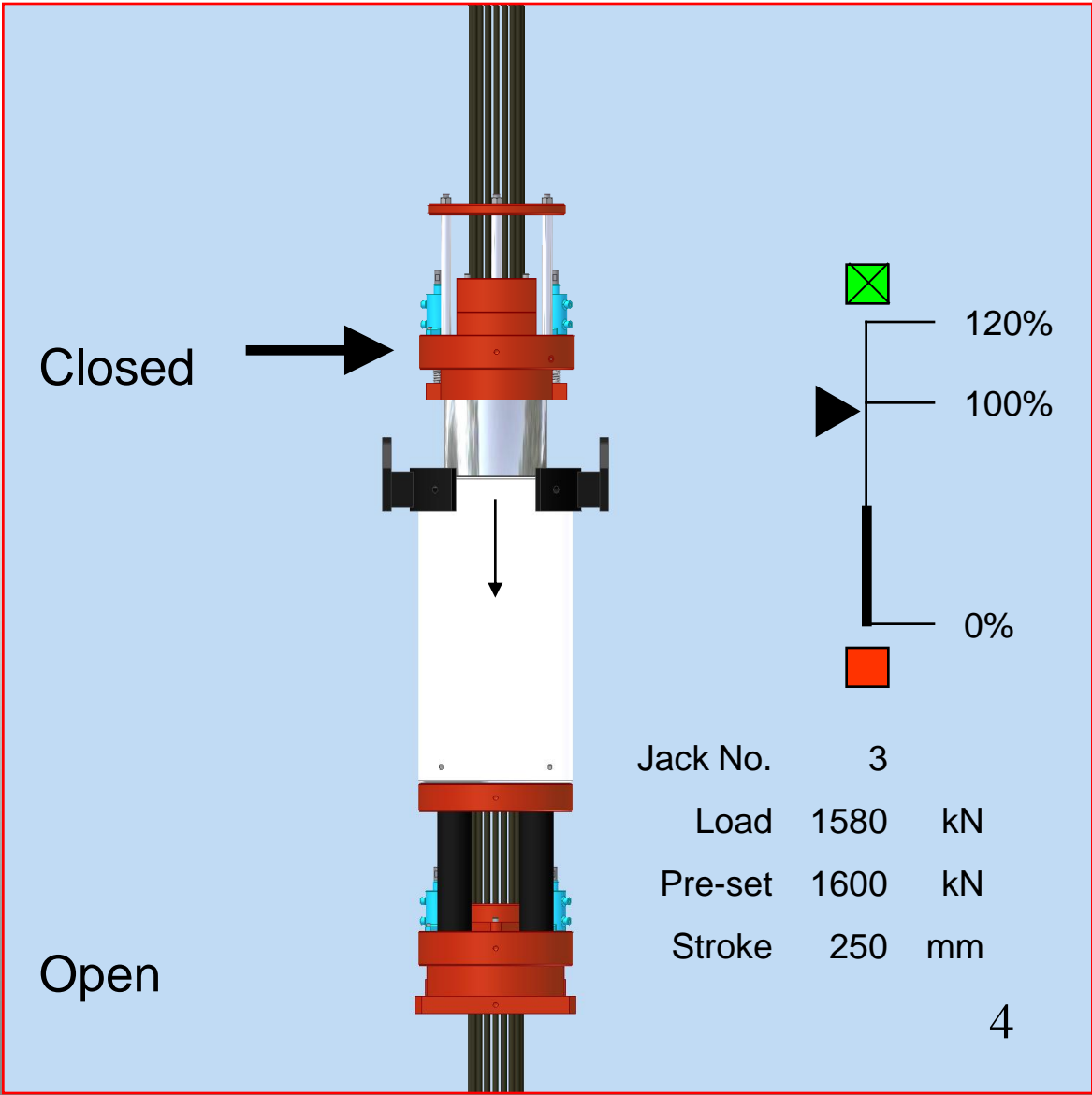

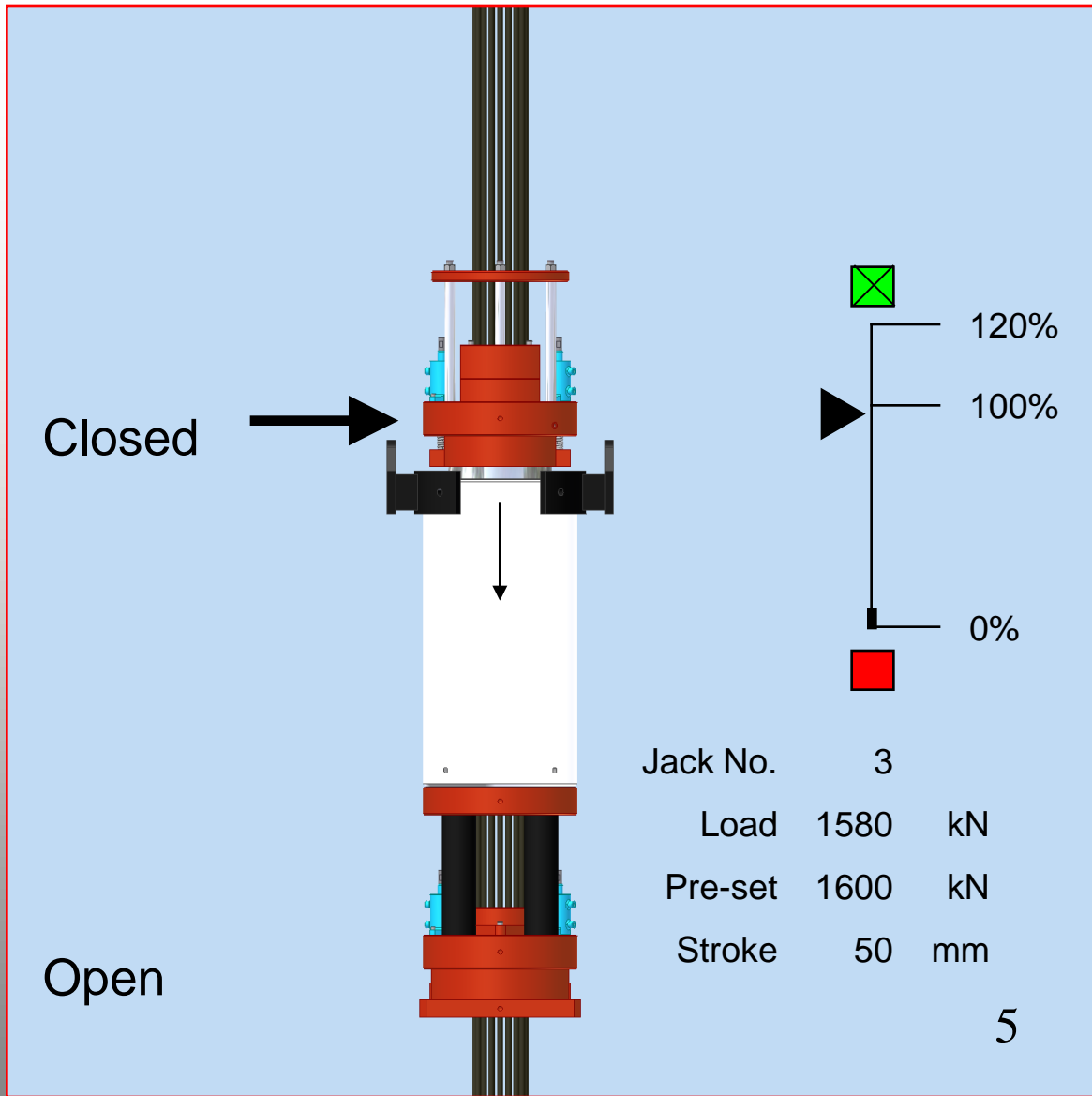

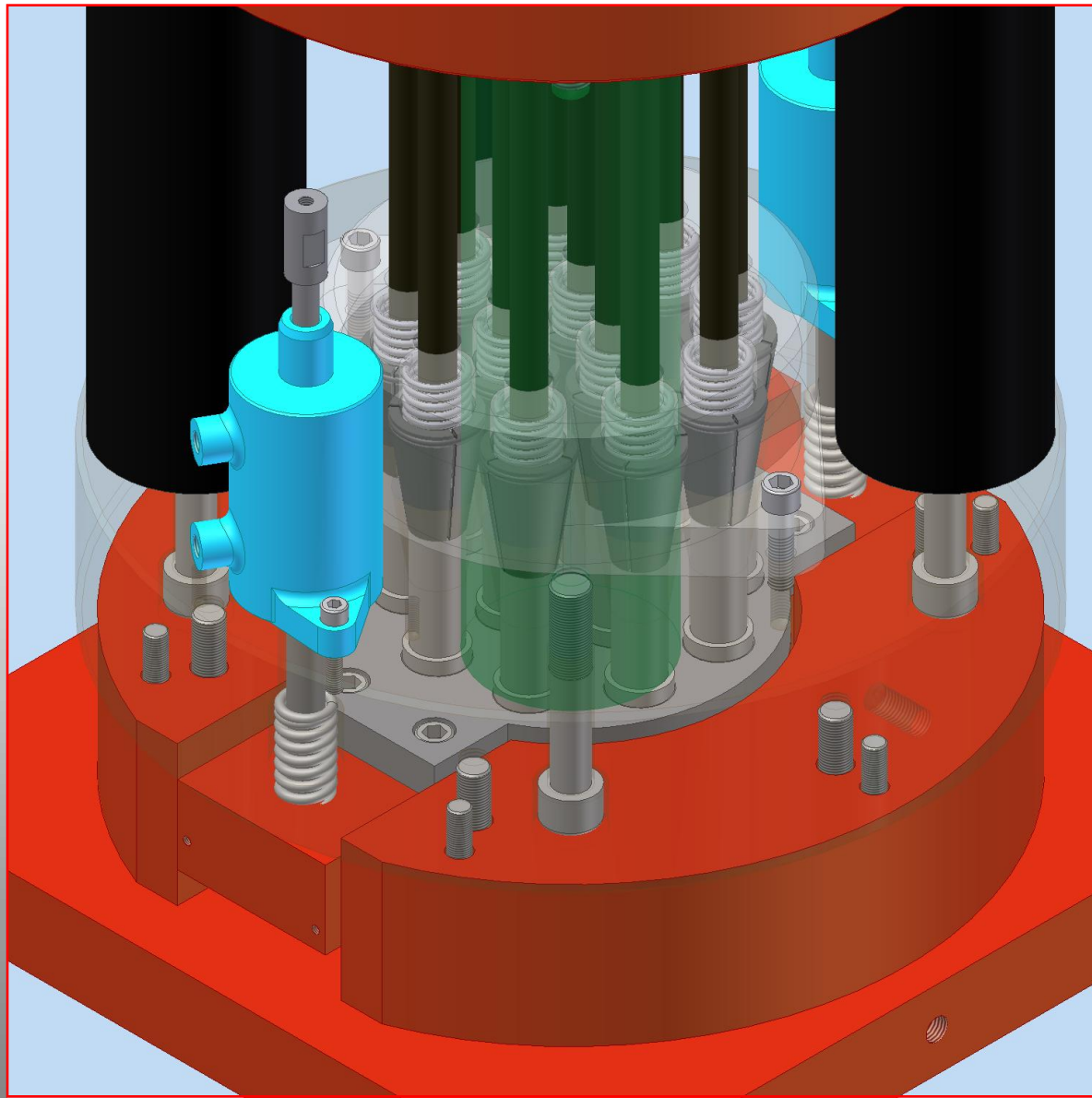

technology

Close bottom anchor

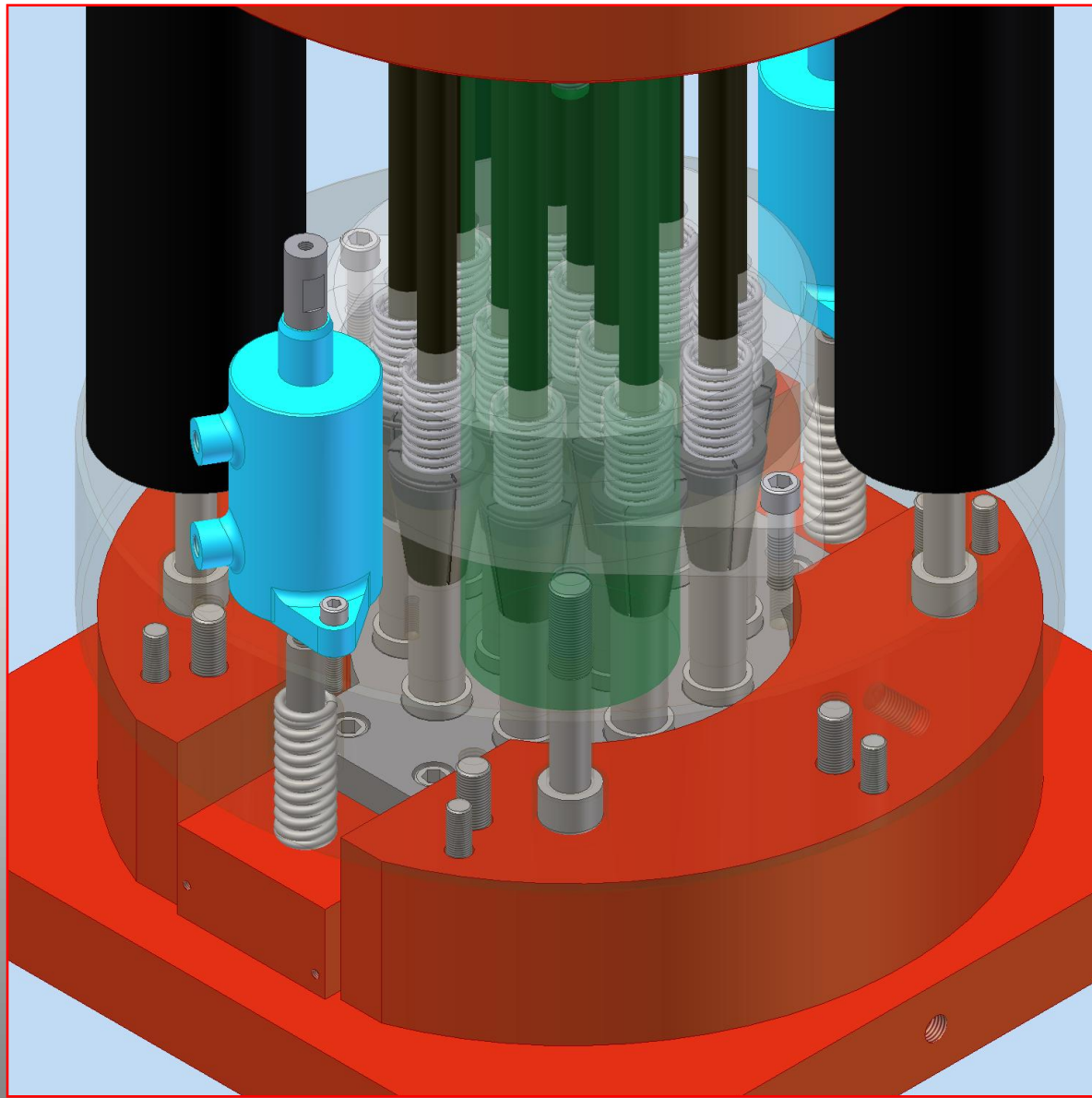

technology

Close bottom anchor

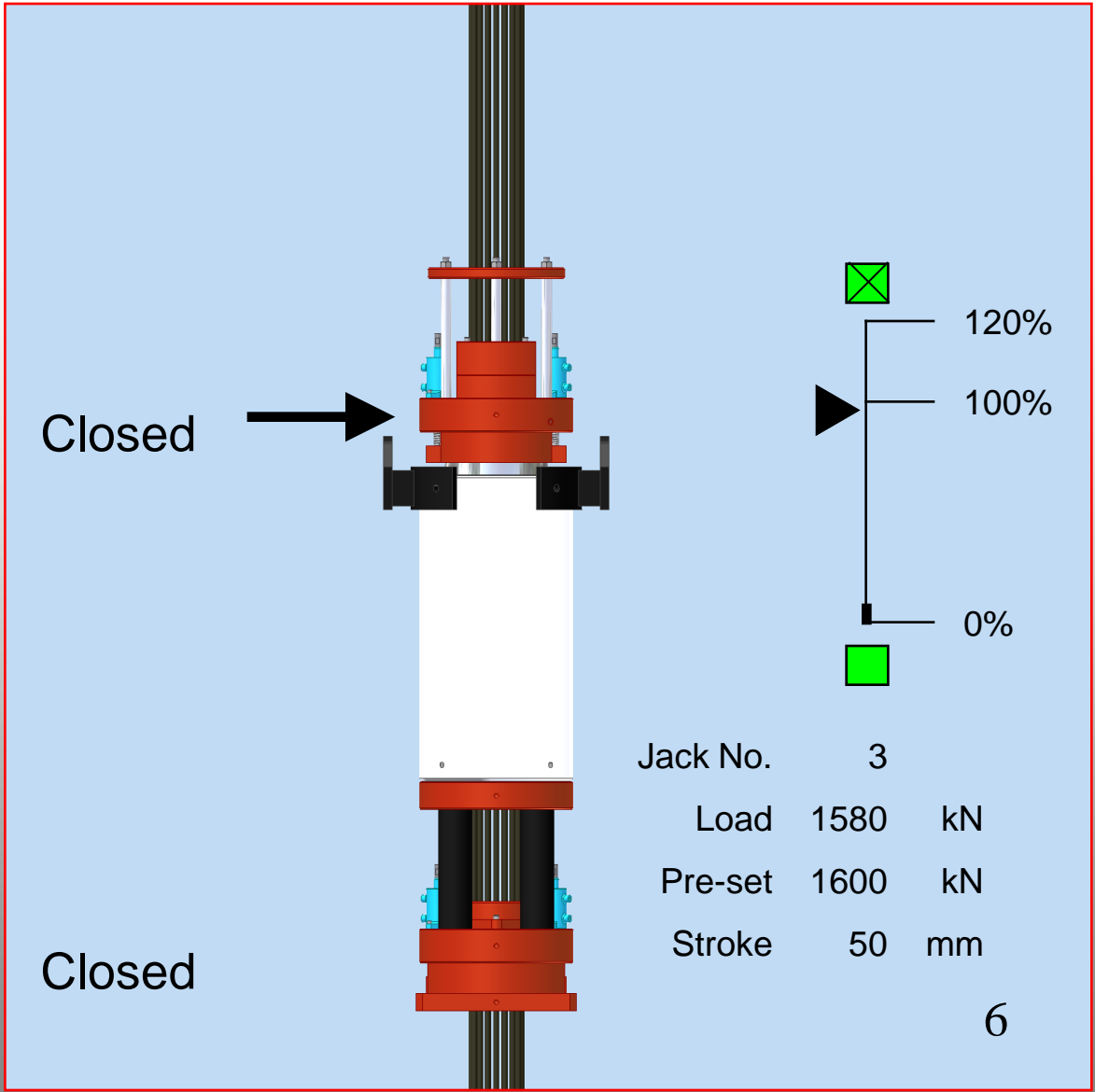

DL technology

Ready to transfer load into bottom anchor

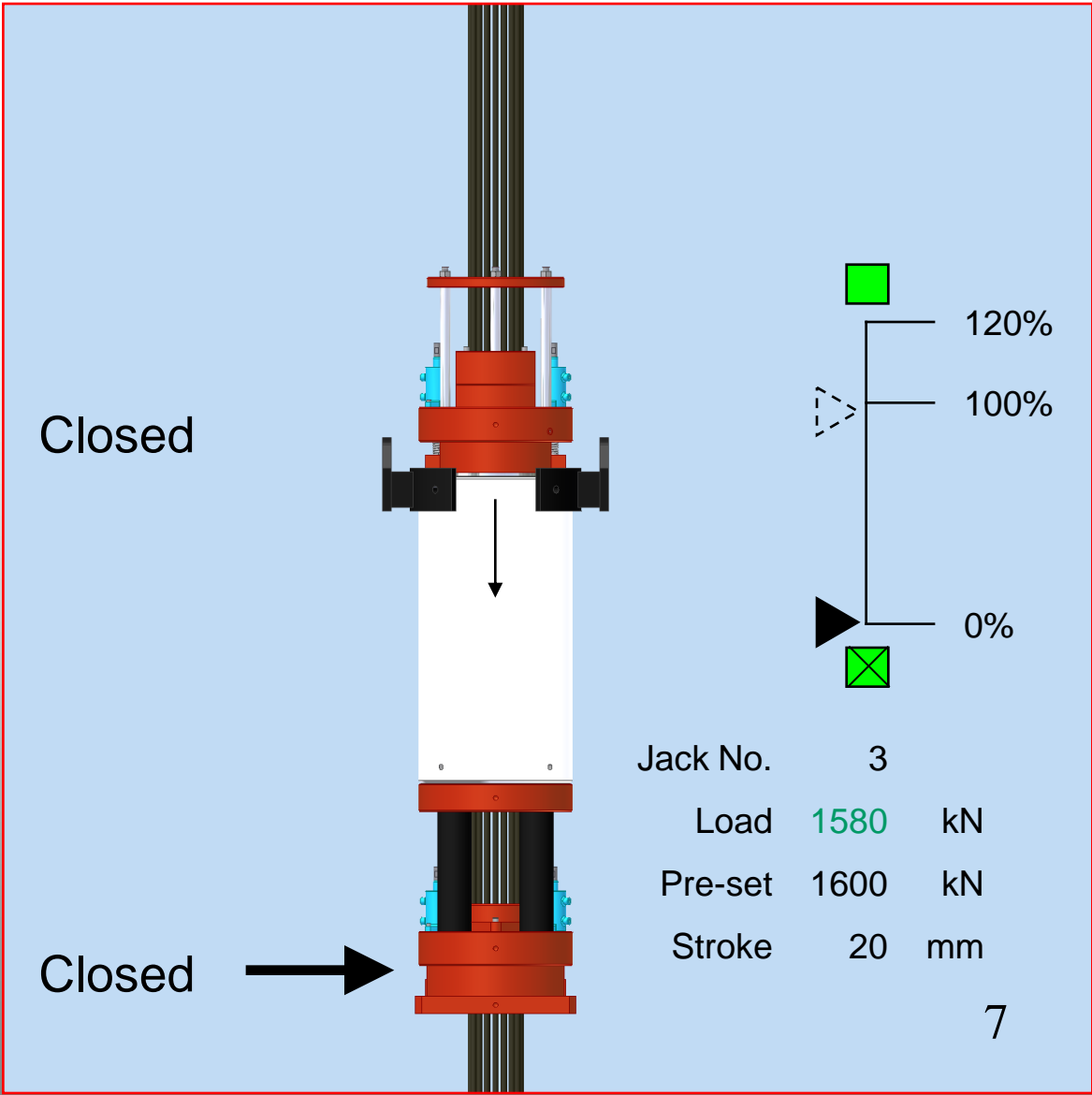

DL technology

Transfer load into bottom anchor

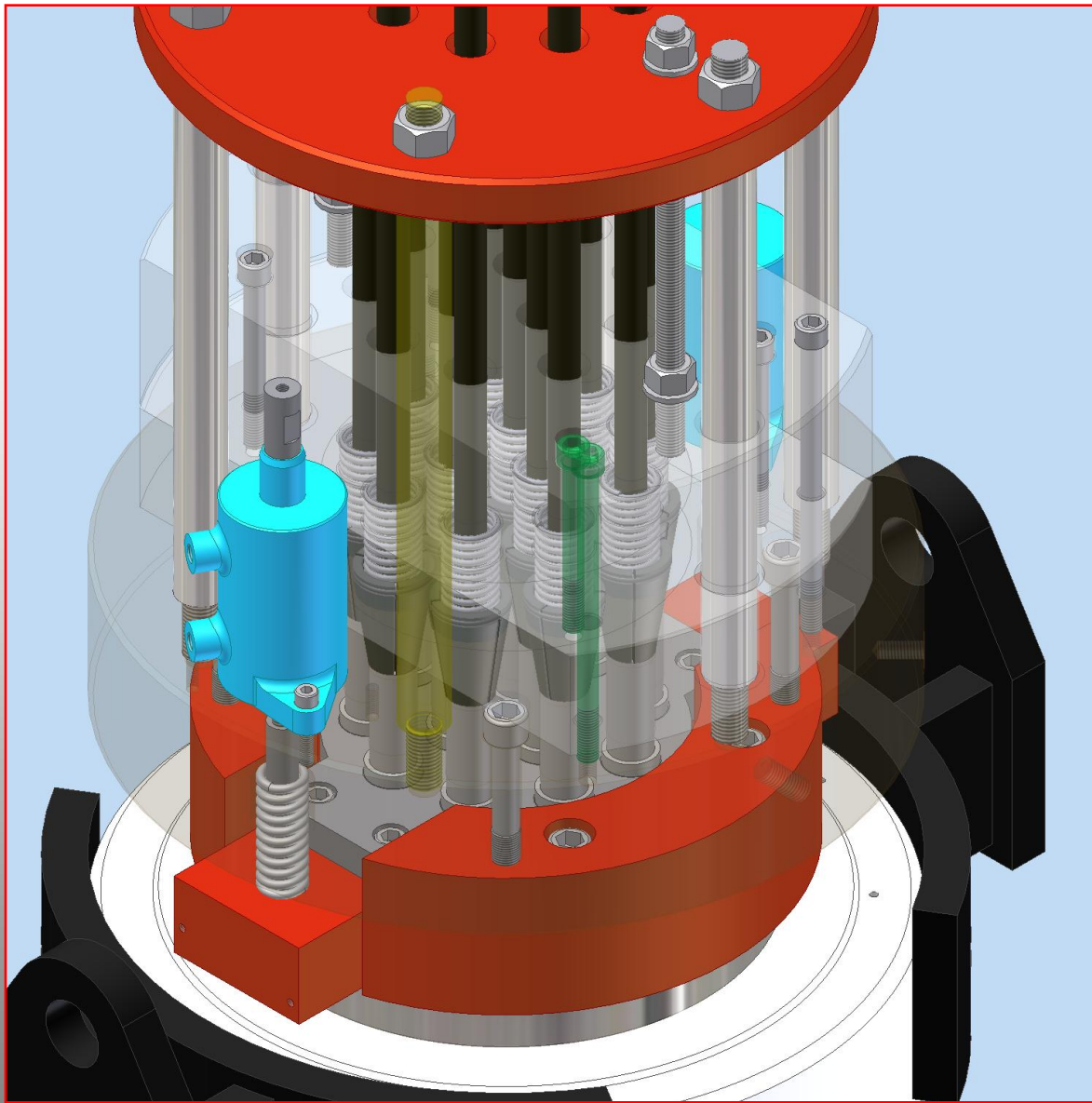

technology

Open top anchor

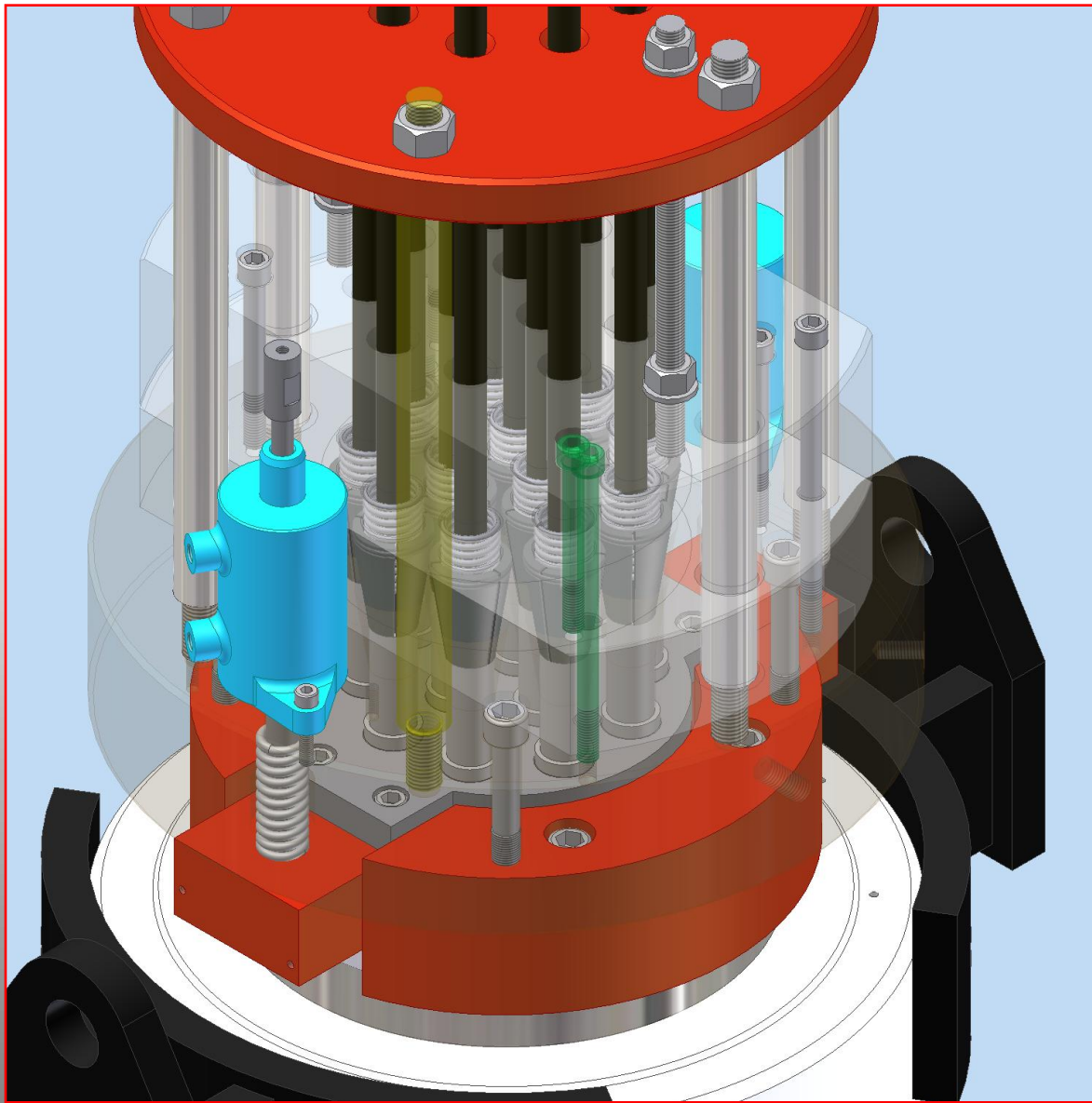

technology

Open top anchor

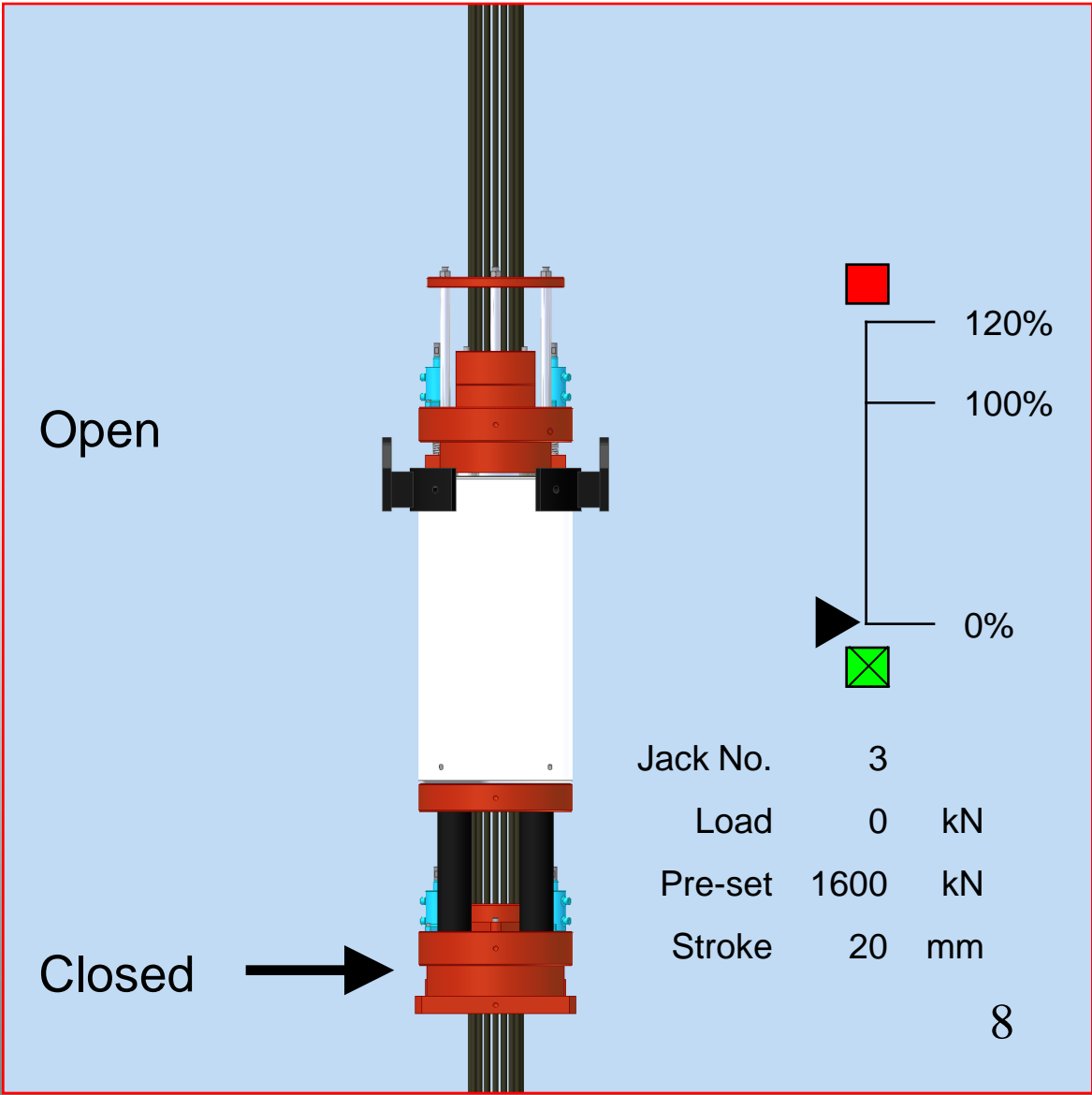

DL technology

Ready for ram extend stroke

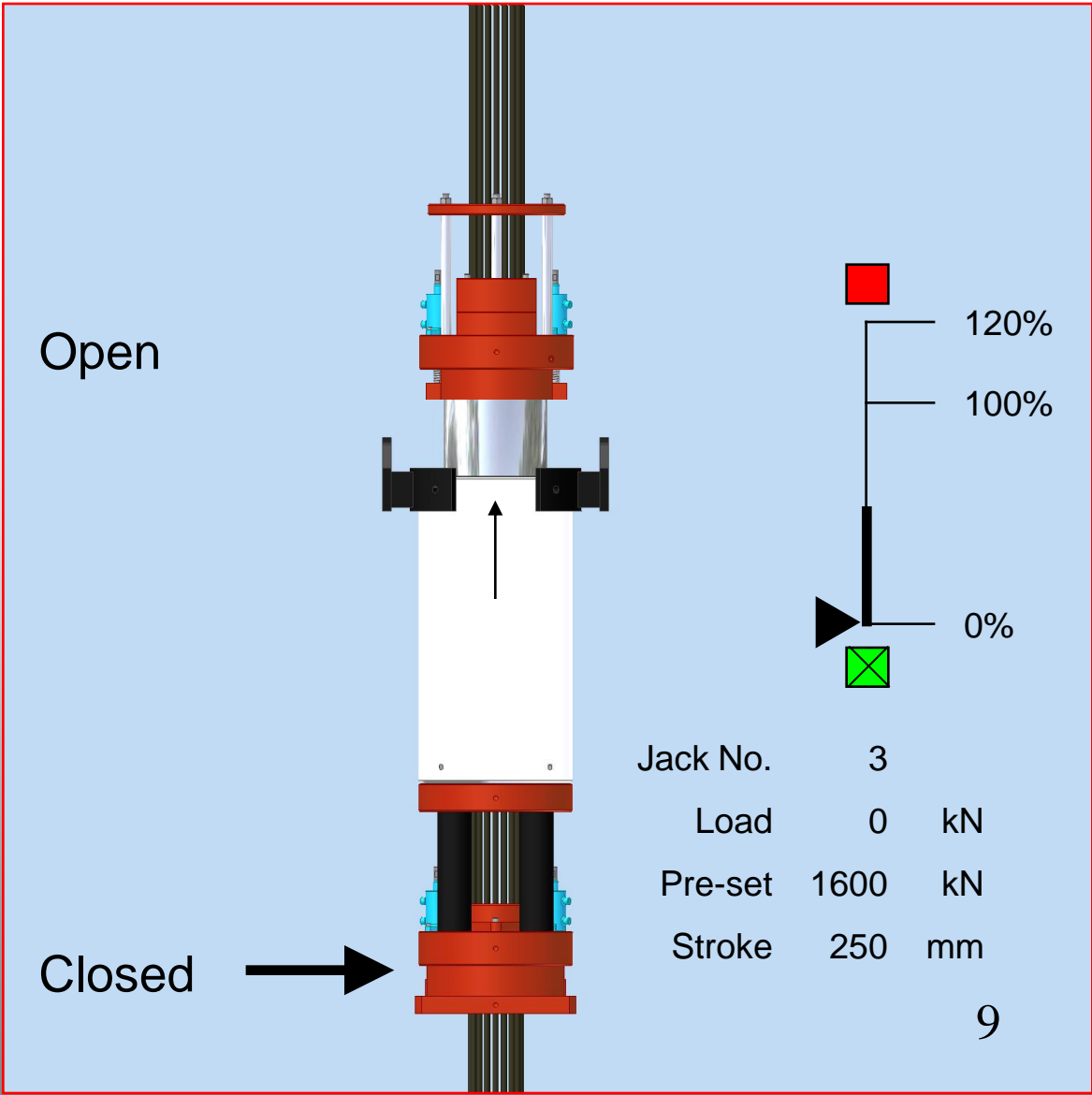

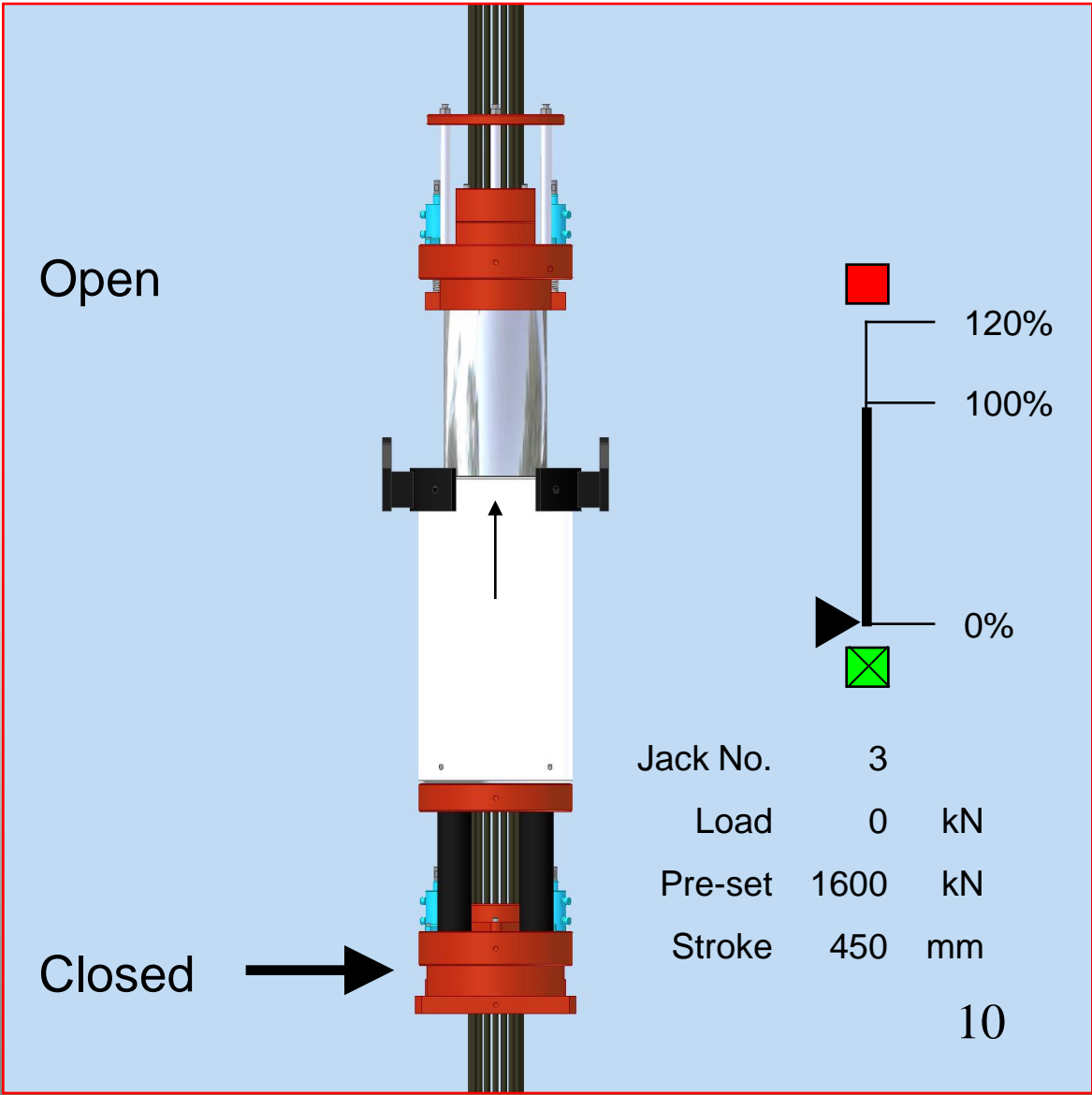

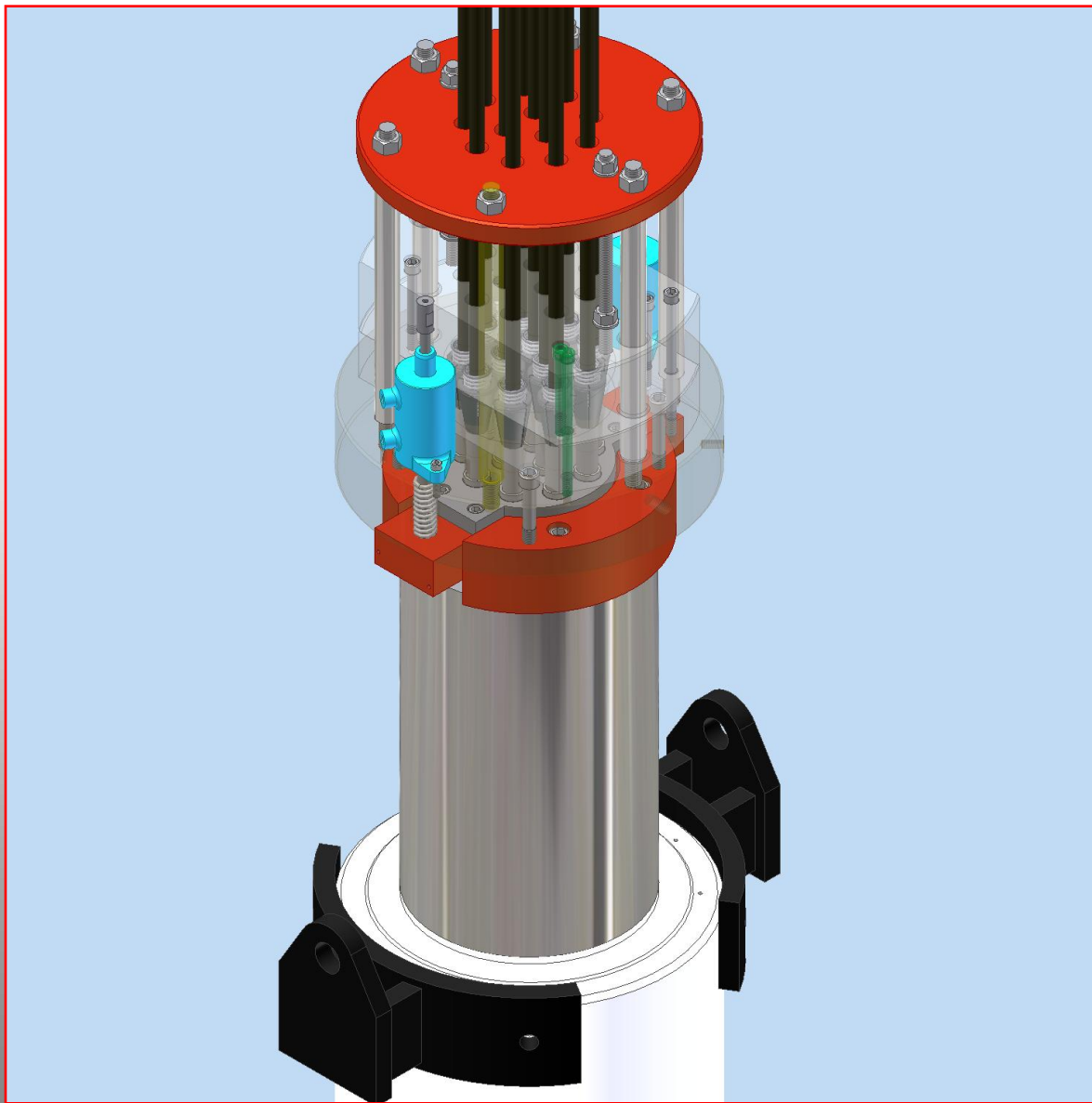

technology

Close top anchor

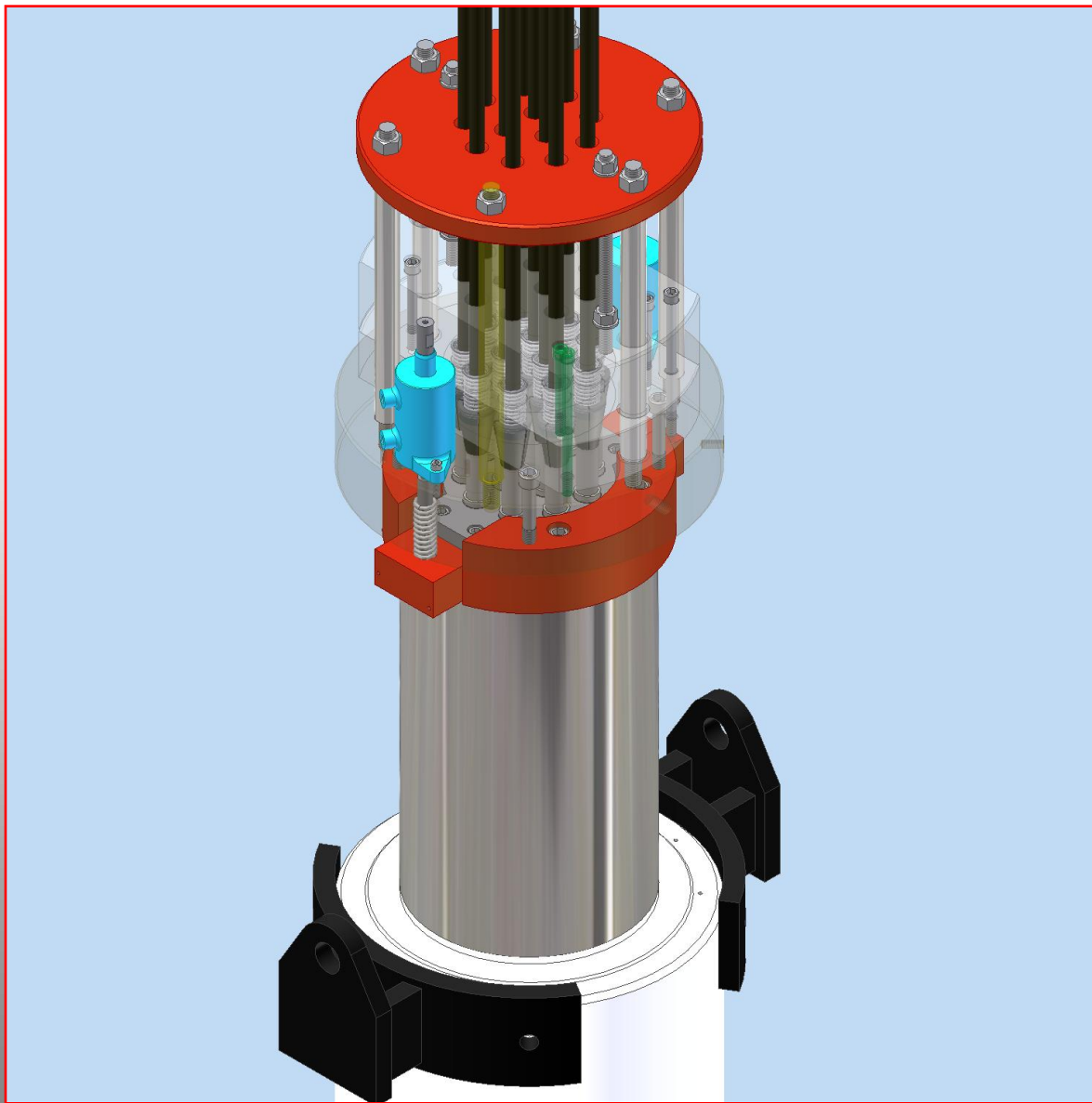

Closed

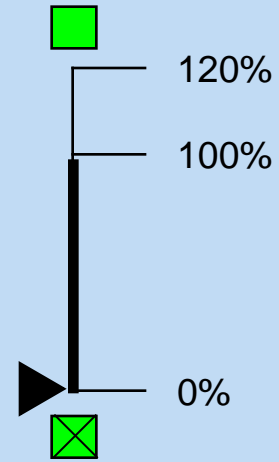
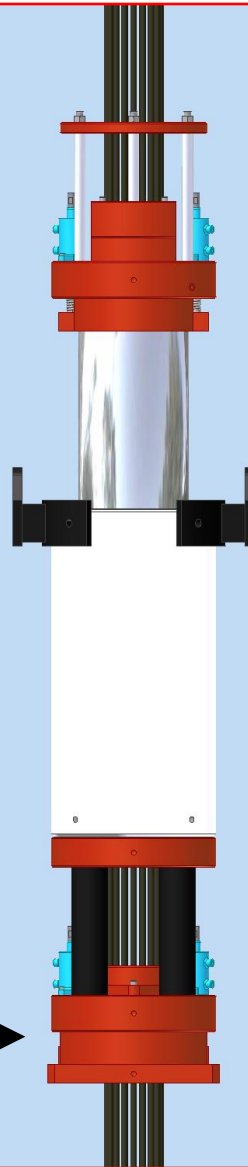

Jack No. 3
Load 0 kN
Pre-set 1600 kN
Stroke 450 mm

Closed



11

[Back](#)