

e+ MAIN LINAC

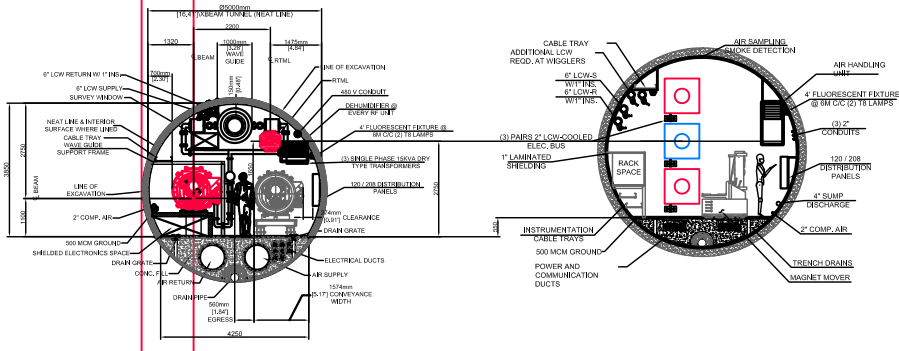

5.0M Q2 TUNNEL
SECTION @ e+ MAIN LINAC (A) **DAMPING RING SHOWN FOR REFERENCE ONLY**

SHEET - 3
Draft
9-06-11

LEGEND

- ELECTRONS
- POSITRONS

TUNNEL CROSSSECTION REFLECT THE AMERICAS GEOLOGIC CONDITIONS.

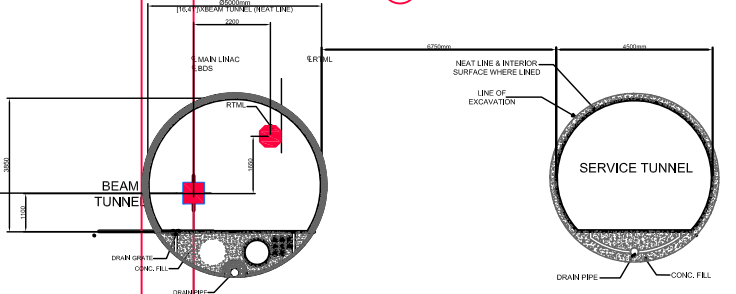

e+ MAIN LINAC : SECTION FROM MAIN LINAC TO e- GUN (B)

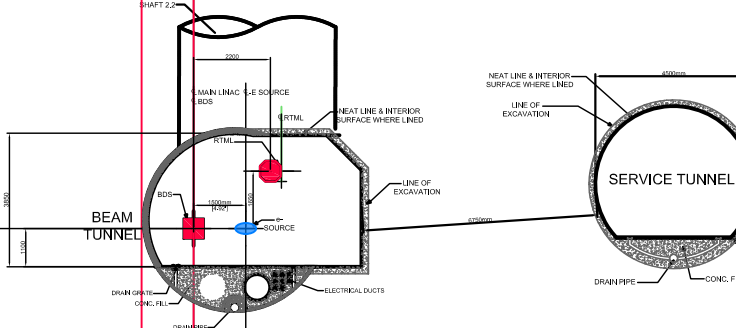

e+ MAIN LINAC : SECTION FROM e- GUN TO 100M PAST 5 GeV LINAC (C)

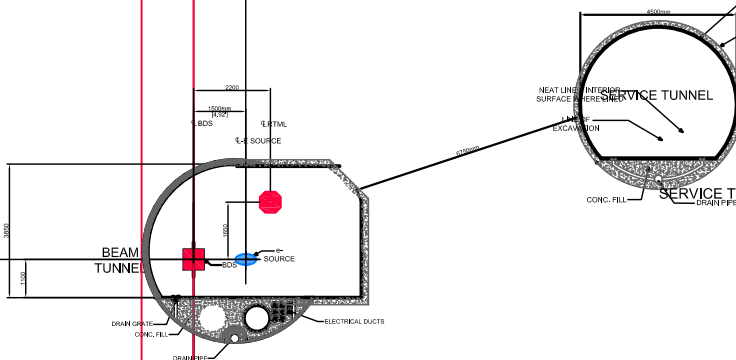

e+ MAIN LINAC : AFTER TRANSITION OF e- SOURCE TO CEILING (D)

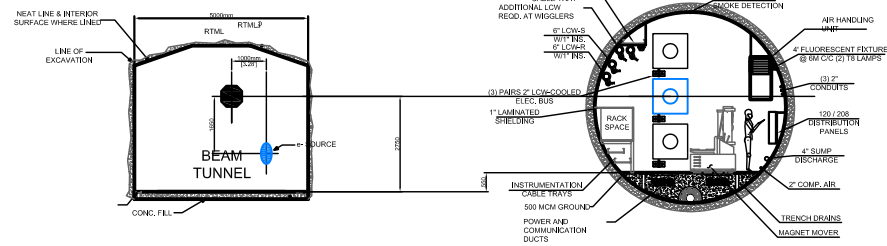

SECTION @ ELTR (H)

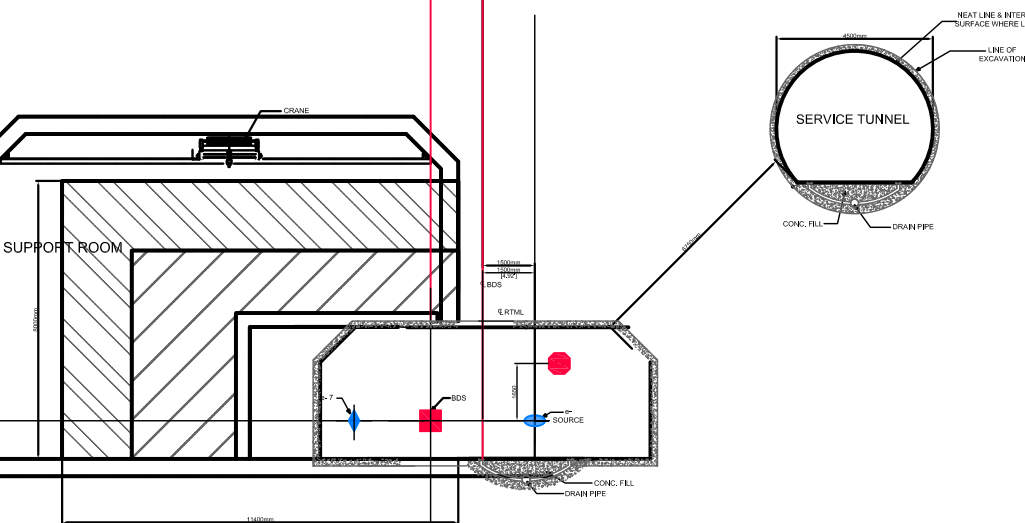

e+ MAIN LINAC : SECTION @ BDS NEAR DETECTOR HALL (E)

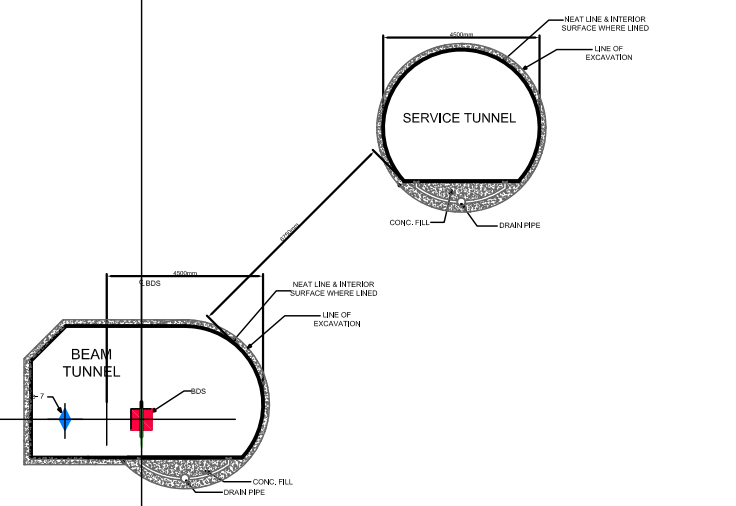

APPROACHING IR (F)