



# Sources of Field Perturbations

LLRF Lecture Part 2

S. Simrock, Z. Geng

ITER / SLAC

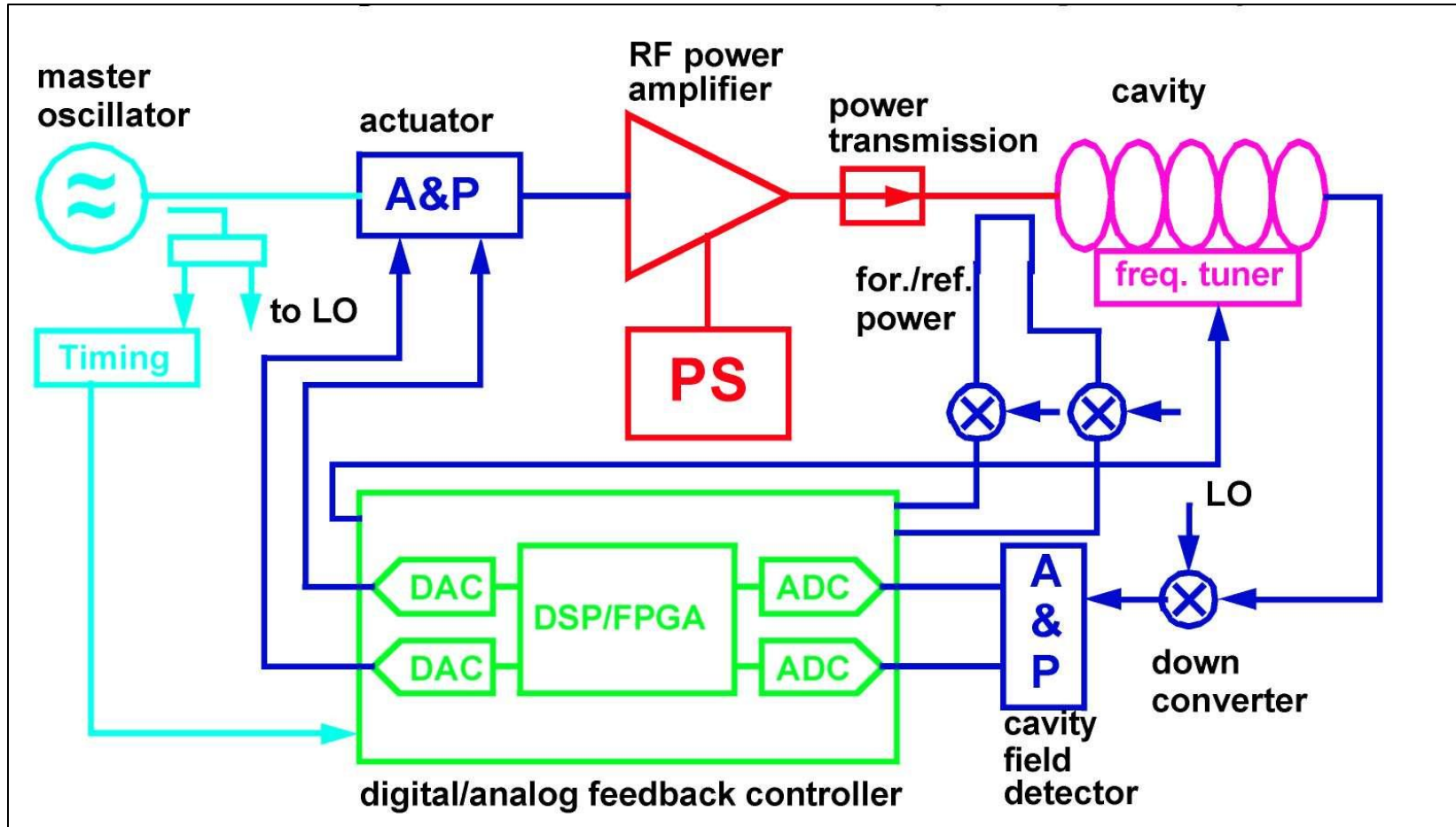



# Sources of Field Perturbations

## o Beam loading

- **Beam current fluctuations**
- Pulsed beam transients
- Multipacting and field emission
- Excitation of HOMs
- Excitation of other passband modes
- Wake fields

## o Cavity drive signal

- HV- Pulse flatness
- HV PS ripple
- **Phase noise from master oscillator**
- Timing signal jitter
- Mismatch in power distribution

## o Cavity dynamics

- cavity filling
- settling time of field

## o Cavity resonance frequency change

- thermal effects (power dependent)

## - **Microphonics**

## - **Lorentz force detuning**

## o Other

- Response of feedback system
- Interlock trips
- **Thermal drifts (electronics, power amplifiers, cables, power transmission system)**

# Lorenz Force Detuning

- Radiation pressure

$$P = \frac{(\mu_0 |\vec{H}|^2 - \epsilon_0 |\vec{E}|^2)}{4}$$

- Resonance frequency shift

$$\Delta f = -K \cdot E_{acc}^2$$

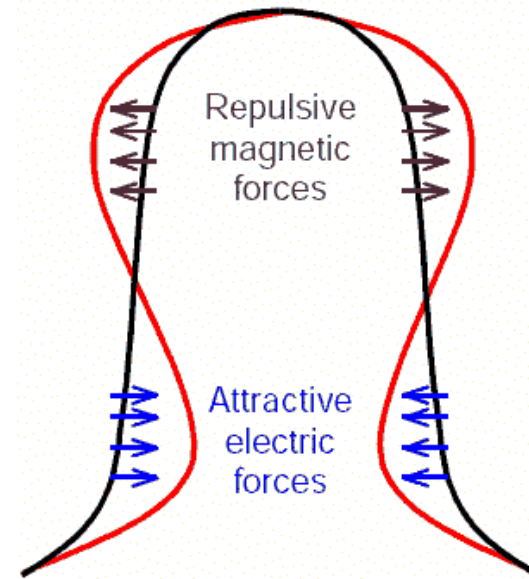



# Lorenz Force Detuning

- Effects of Lorenz force detuning
  - Change cavity voltage and phase during RF pulse
  - Generate more reflection power
  - Limit maximum repetition rate of RF pulses
- Properties
  - Gradient dependent
  - Predictable from pulse to pulse
  - Perturbations are correlated from cavity to cavity

## TESLA 9-cell cavity

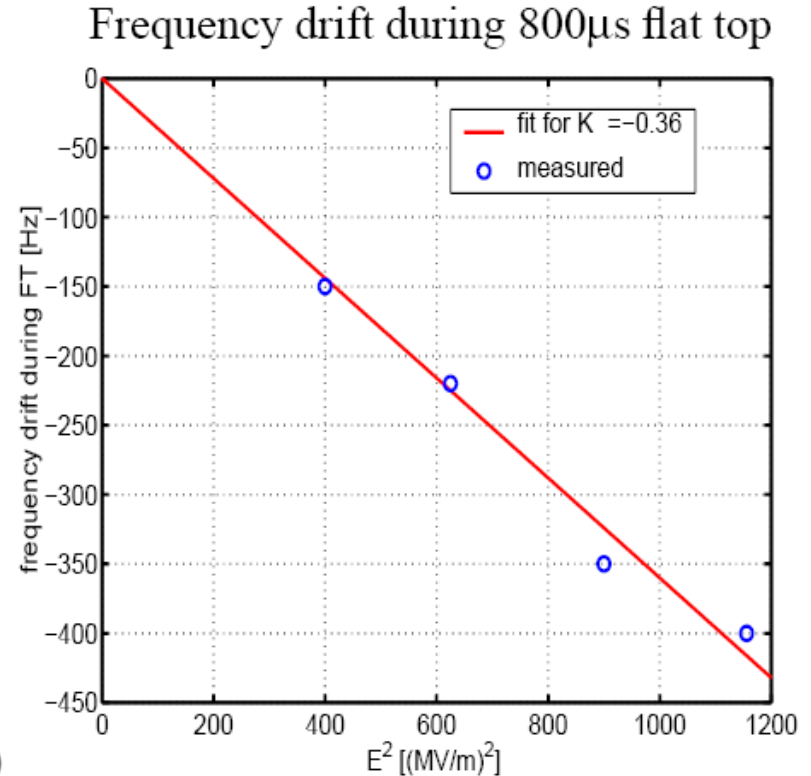
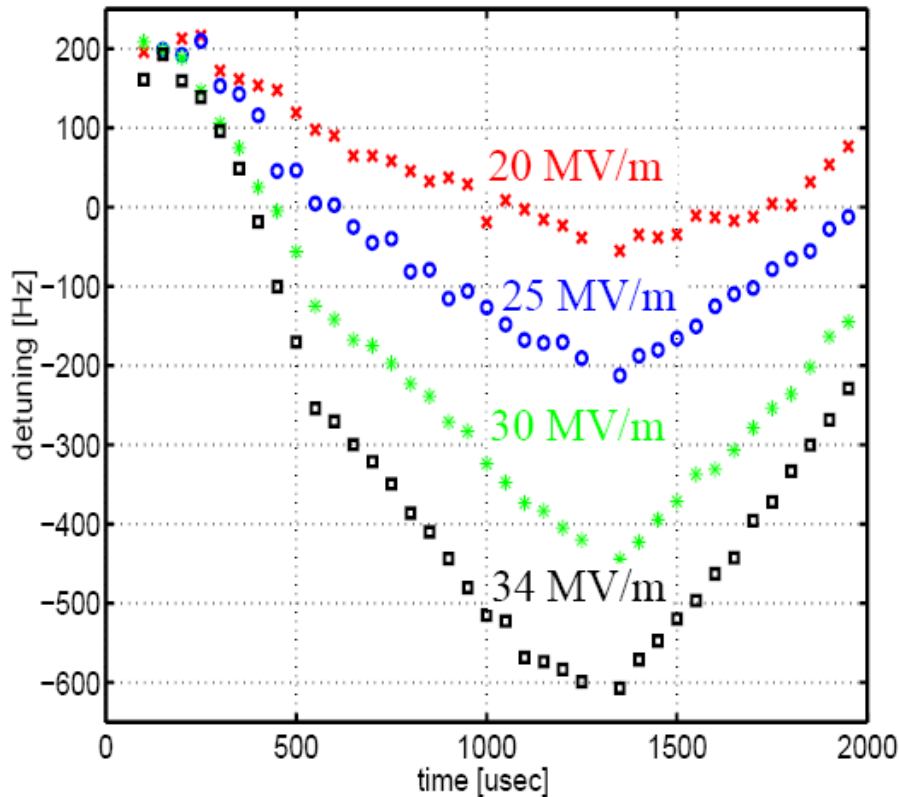

Frequency drift during 950 µs flat top (TESLA 9-cell cavity):

$$\Delta f_{FT} \approx -(0.4 \text{ to } 0.65) \frac{\text{Hz}}{\text{MV/m}^2} E_{acc}^2$$

# Microphonics



# Sources of Microphonics

- Mechanical vibrations caused by the accelerator environment are always present and may be transferred to the cavity.

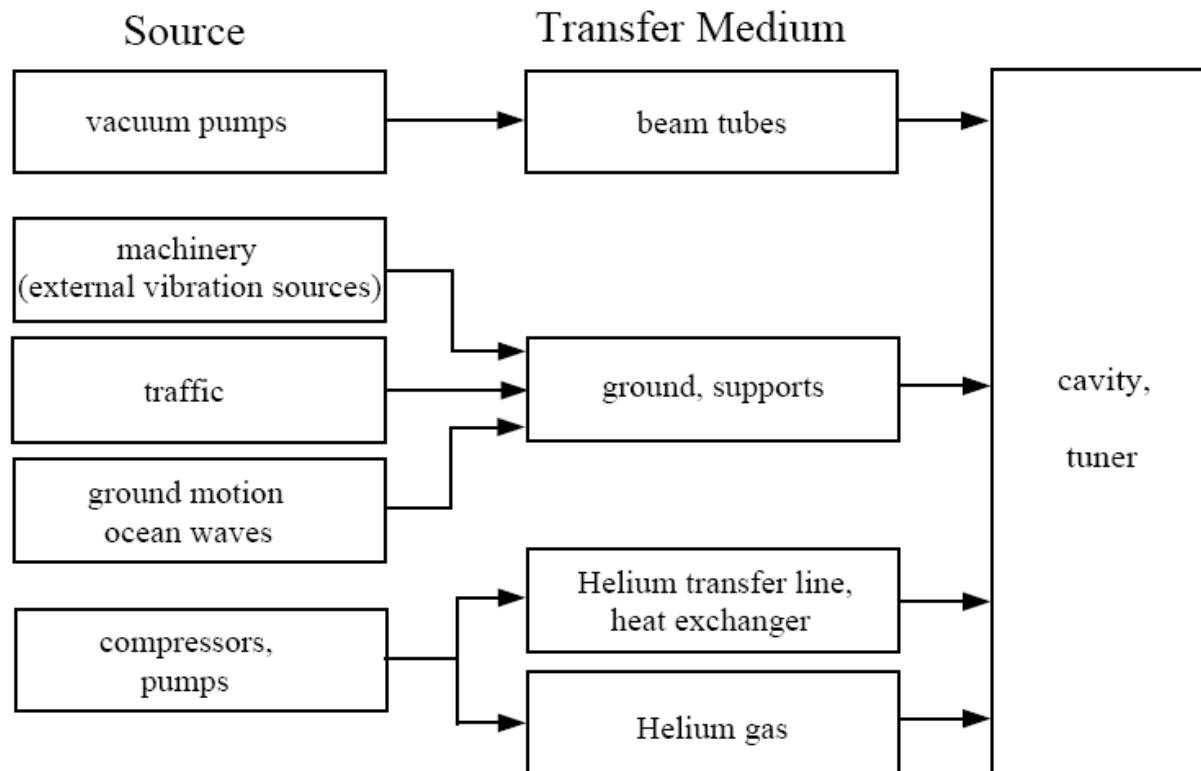

- Effects of microphonics
  - It mainly influences the resonance frequency of the cavity and therefore the RF phase with respect to the beam
- Properties
  - Slow perturbation
  - Not predictable
  - Uncorrelated along the Linac

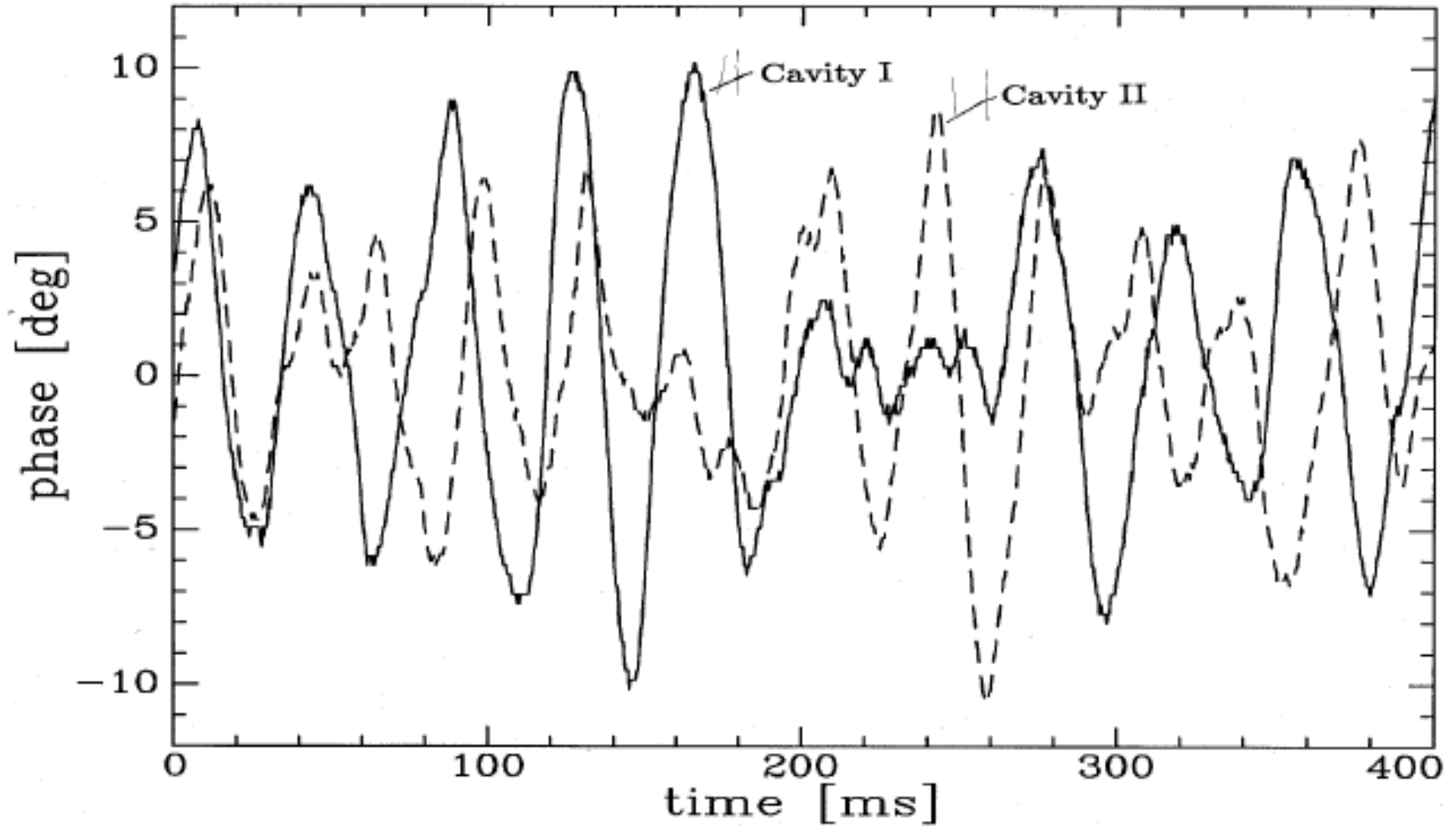



# Microphonics at FLASH

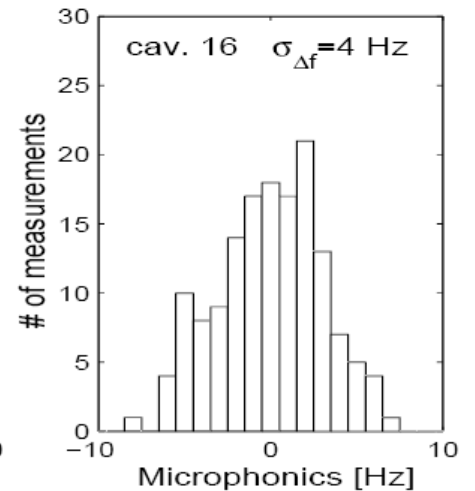
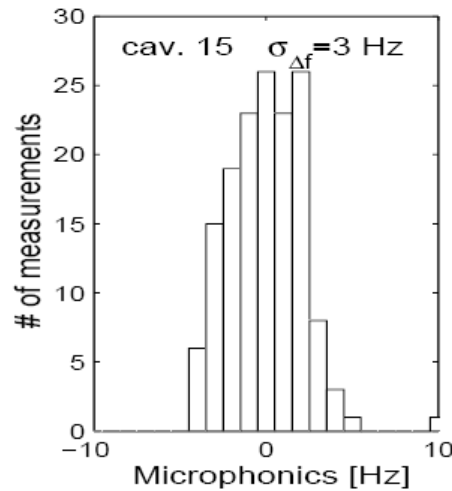
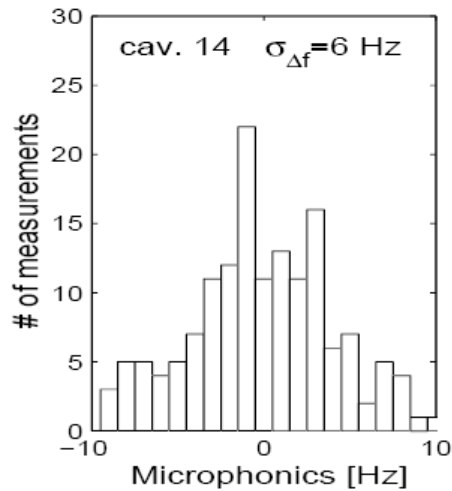
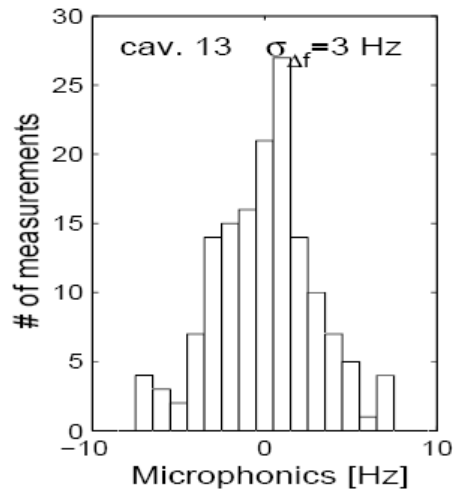
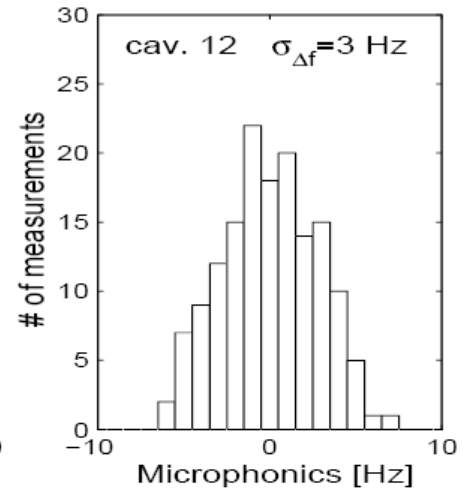
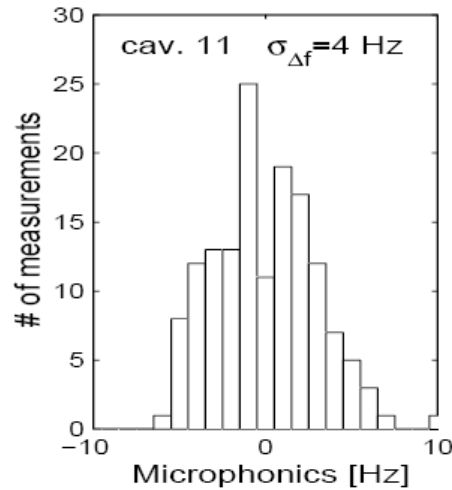
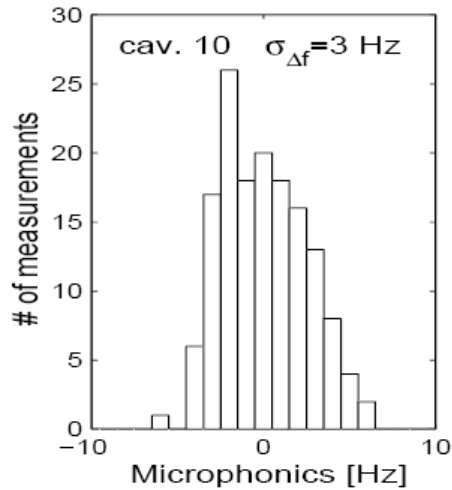
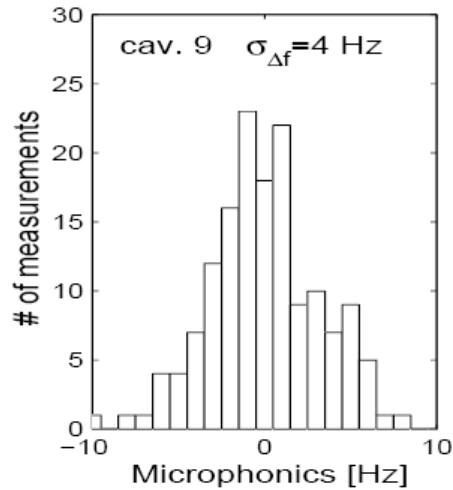

# Beam Current (Bunch Charge) Fluctuation

# Beam Loading Effect

- Single bunch transient is not controllable
- Bunch charge fluctuation will introduce energy spread

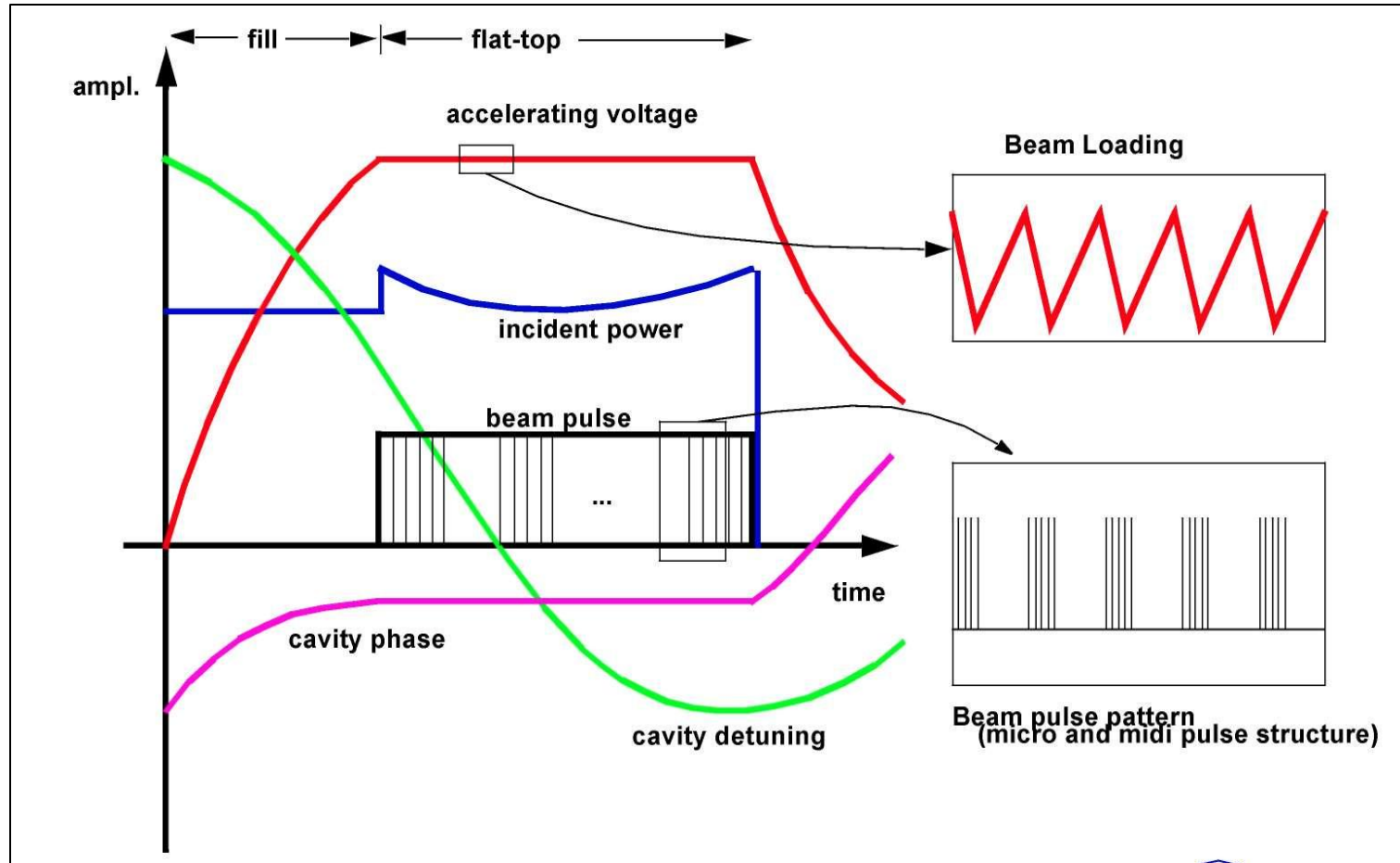



# Bunch Charge Pattern at FLASH

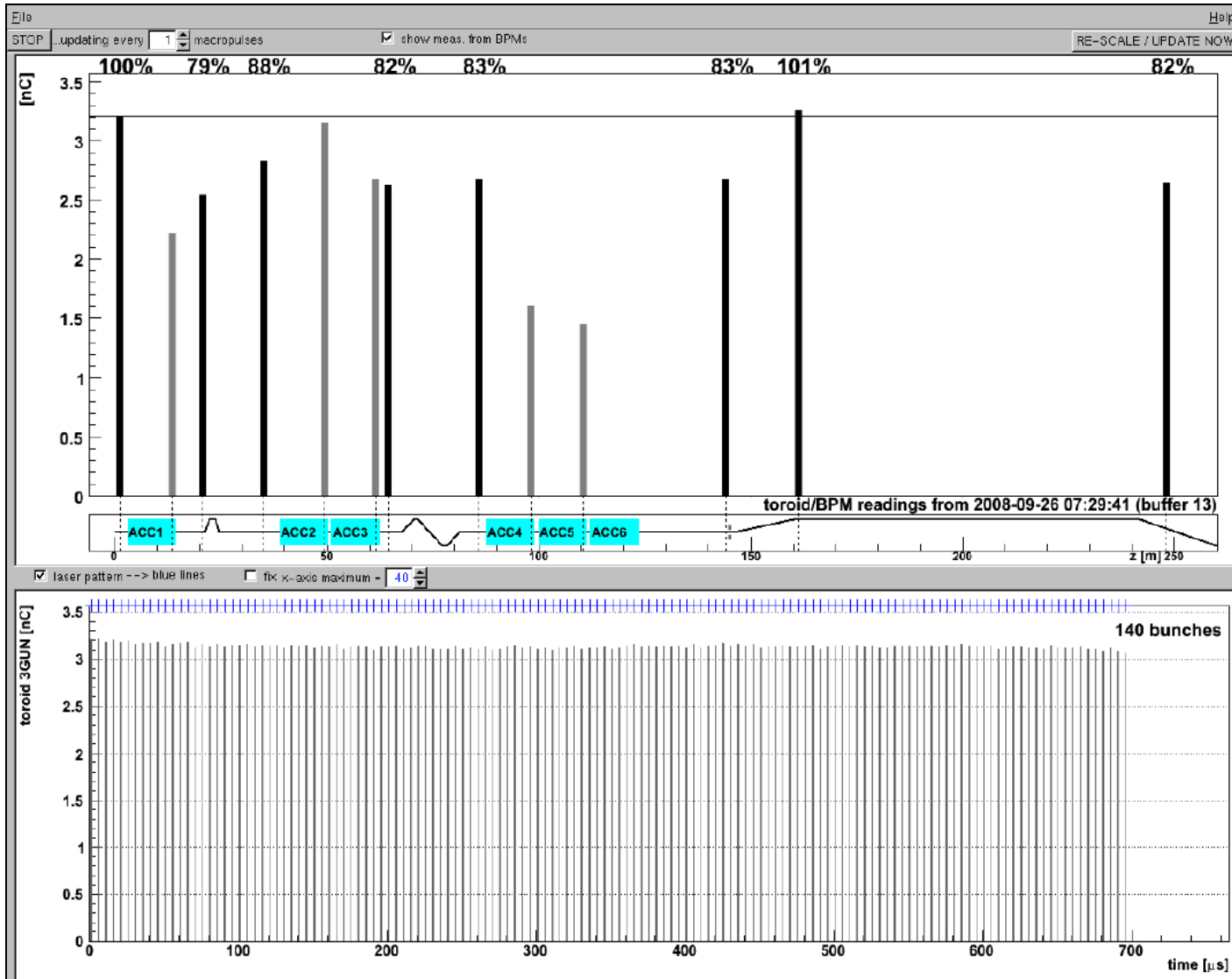

# Phase Noise of Master Oscillator





# Phase Noise of FLASH MO

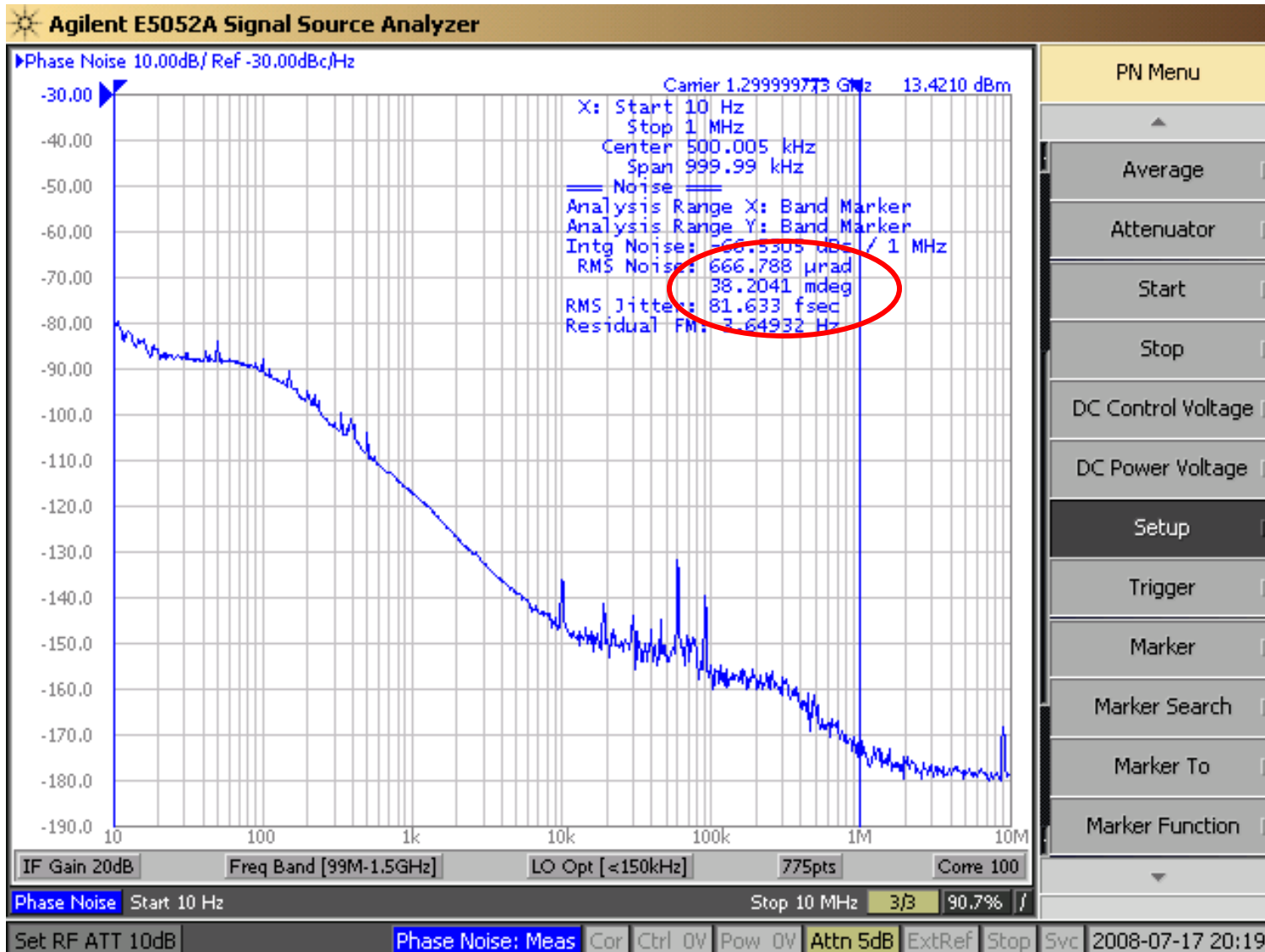

# Thermal Drift



# Phase Drift of 80 m 7/8" Reference Line at FLASH

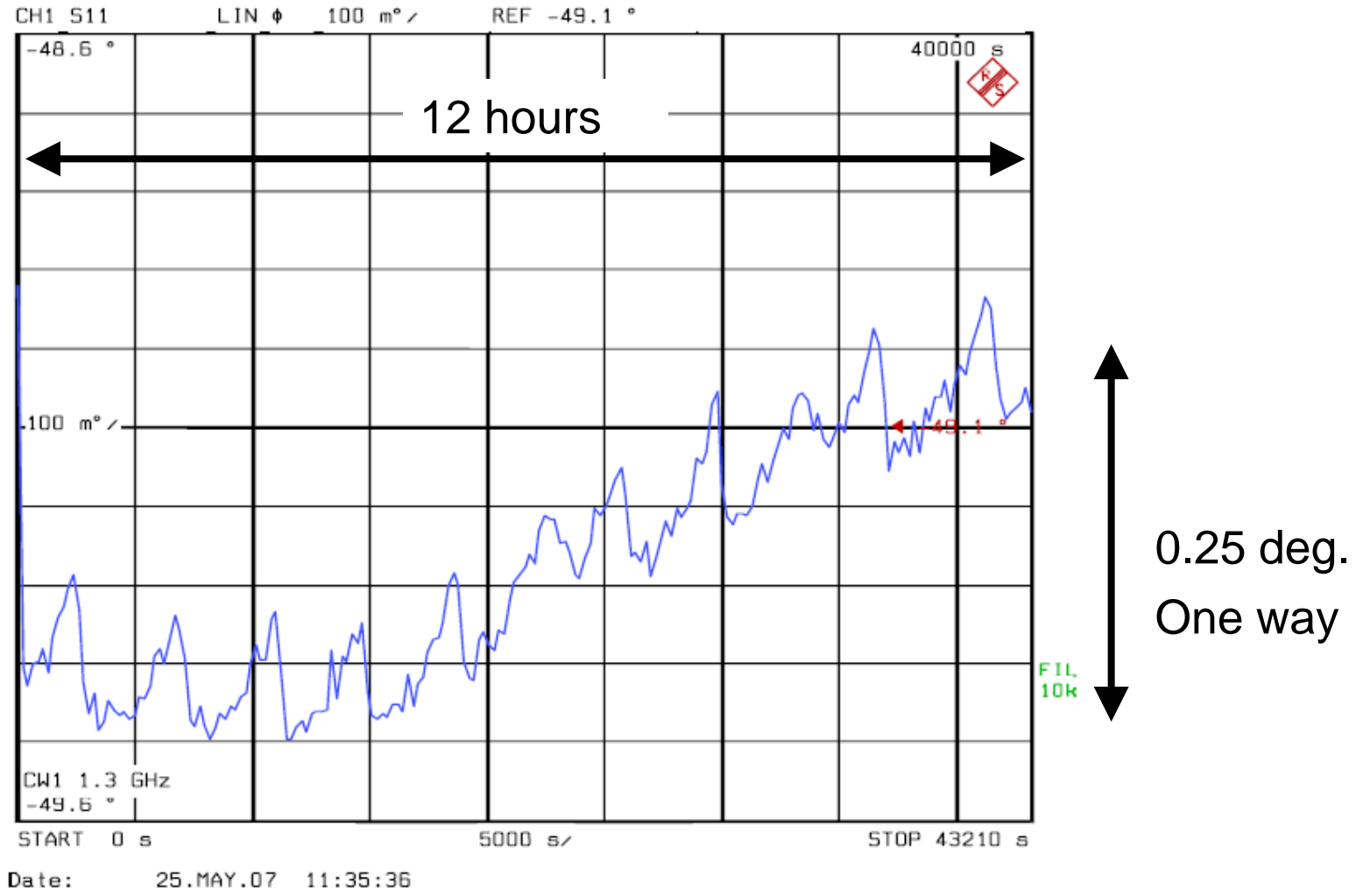

# Error Map

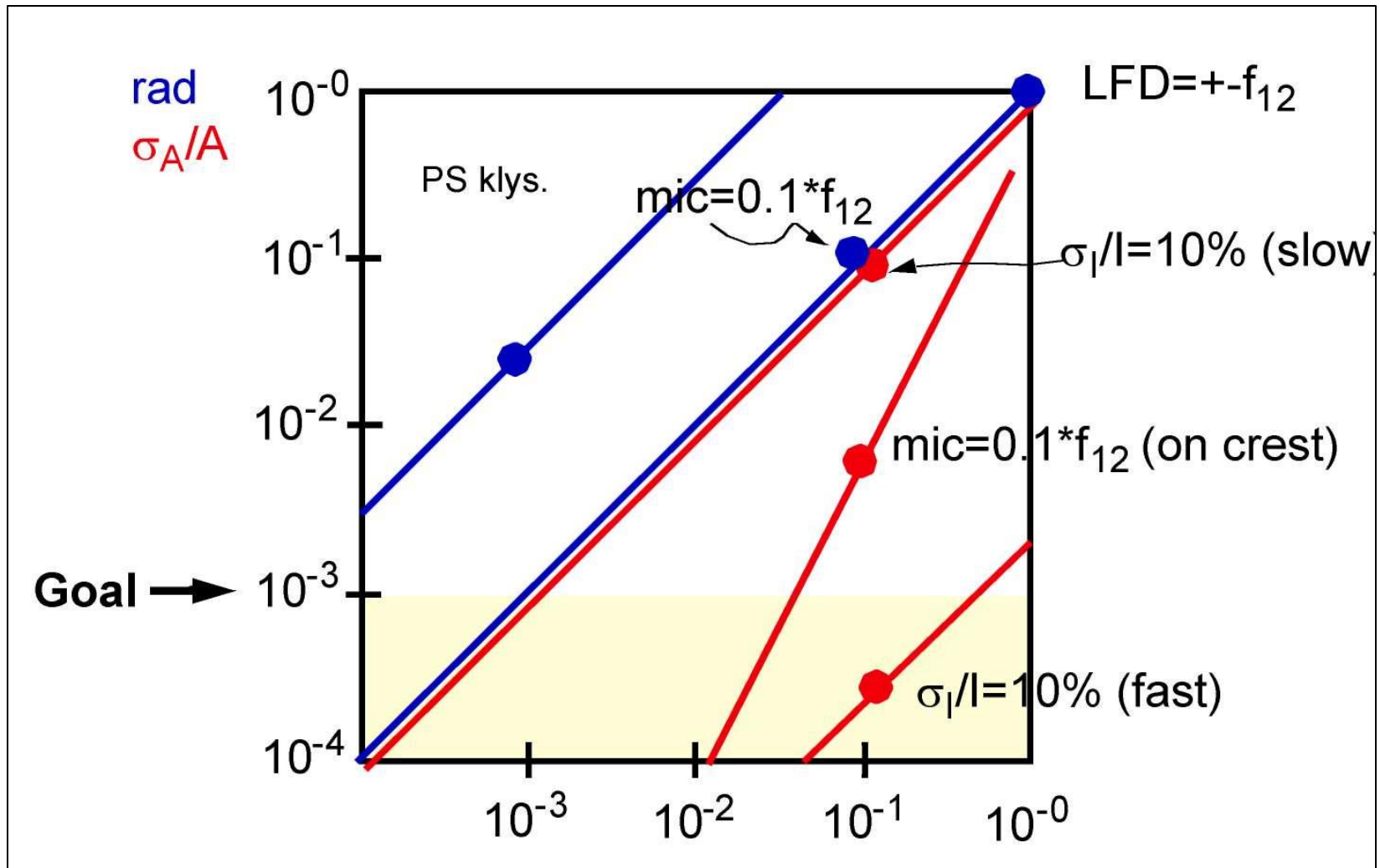

- [1] T. Schilcher. Vector Sum Control of Pulsed Accelerating Fields in Lorentz Force Detuned Superconducting Cavities. Ph.D. Thesis of DESY, 1998
- [2] V. Ayvazyan, S. Simrock. Dynamic Lorenz Force Detuning Studies in TESLA Cavities. EPAC 2004, July 2004.