

Where is dark matter ?

- the WIMP miracle (reminder)

 - back to MSSM

 - relic density

 - interaction with matter

- some recent non-accelerator experimental results (summer 13')

- some global fits

 - CMSSM (frequentist and Bayesian)

 - beyond CMSSM and MSSM

- invisible Higgs

- 2 examples from extra dimensions

- asymmetric DM

- effective field theory approaches (and limitations)

- possible searches at lepton colliders

Implication of Planck results

global fit to cosmological parameters, combining Planck with other measurements (1303.5076)

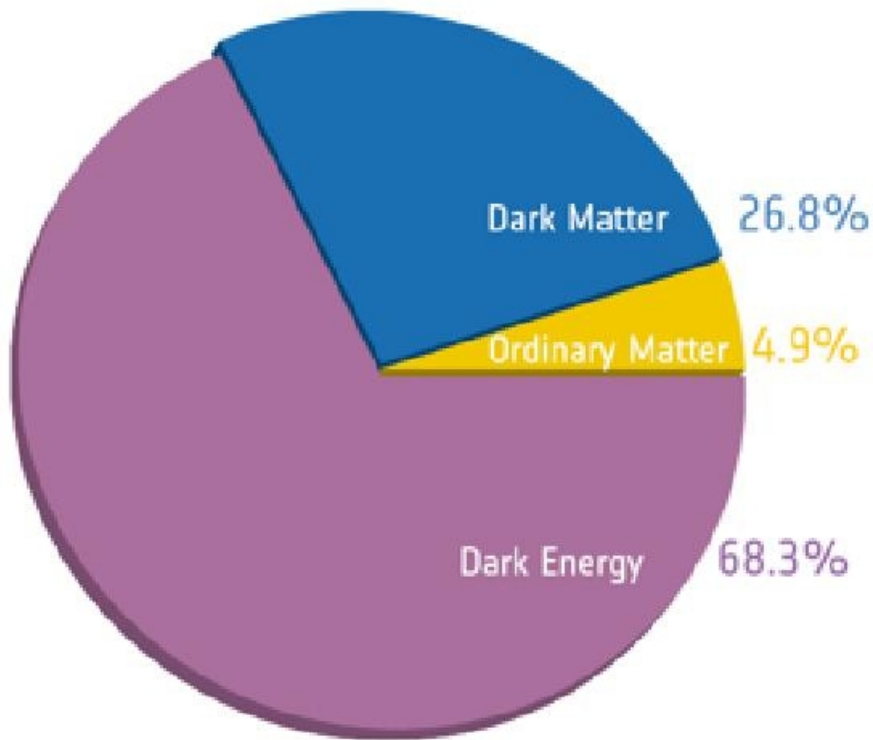

$$\text{baryons } \Omega_b h^2 = 0.02214 \pm 0.00024$$

$$\text{CDM } \Omega_{DM} h^2 = 0.1187 \pm 0.0017$$

$$\text{Dark energy } \Omega_\Lambda = 0.692 \pm 0.010$$

$$H_o \quad h = 0.6780 \pm 0.0077$$

Where is dark matter ?

- the WIMP miracle (reminder)

 - back to MSSM

 - relic density

 - interaction with matter

- some recent non-accelerator experimental results (summer 13')

- some global fits

 - CMSSM (frequentist and Bayesian)

 - beyond CMSSM and MSSM

- invisible Higgs

- 2 examples from extra dimensions

- asymmetric DM

- effective field theory approaches (and limitations)

- possible searches at lepton colliders

The WIMP “miracle”

'initially' the early universe is dense and hot and all particles are in thermal equilibrium
the universe then cools to temperature T below the dark particle's mass m_X

⇒ number of dark particles becomes 'Boltzmann' suppressed
i.e. dropping exponentially as $e^{-m_X / T}$

the number of dark matter particle would drop to zero

except that in addition to cooling the universe is also expanding !

eventually the universe becomes so large and the gas so dilute
that the dark matter particles cannot find each other to annihilate

⇒ **the dark matter particles then 'freeze out'**

with their number asymptotically approaching a constant

i.e. their thermal relic density

note that freeze out also known as chemical decoupling is distinct from kinetic decoupling
but interactions that mediate energy exchange between dark matter and other particle may remain efficient
after thermal freeze out interactions that change the number of dark matter particle become negligible

The WIMP "miracle"

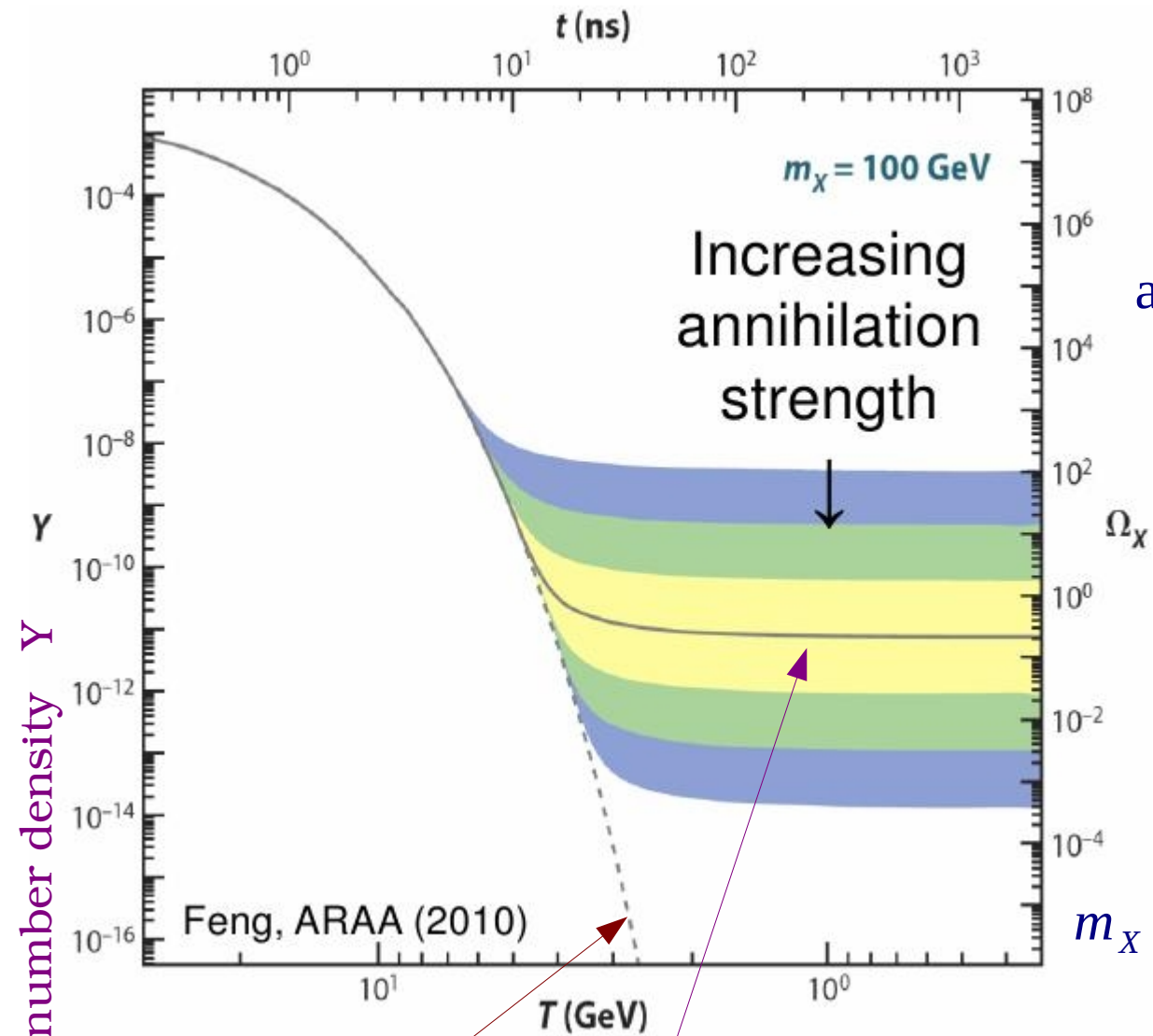

thermal freeze out :
 the relation between Ω_X
 (the thermal relic density)
 and annihilation strength is simple :

$$\Omega_X \propto \frac{1}{\langle \sigma v \rangle} \sim \frac{m_X^2}{g_X^4}$$

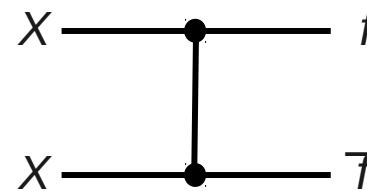

$$m_X \sim 100 \text{ GeV}, g_X \sim 0.6 \rightarrow \Omega_X \sim 0.1$$

solid line is for annihilation cross section that yield the correct relic density
 shaded regions are for cross section that differ by 10, 10^2 and 10^3
 from this value

number density of particle that would remain in thermal equilibrium

Some Dark Matter candidates

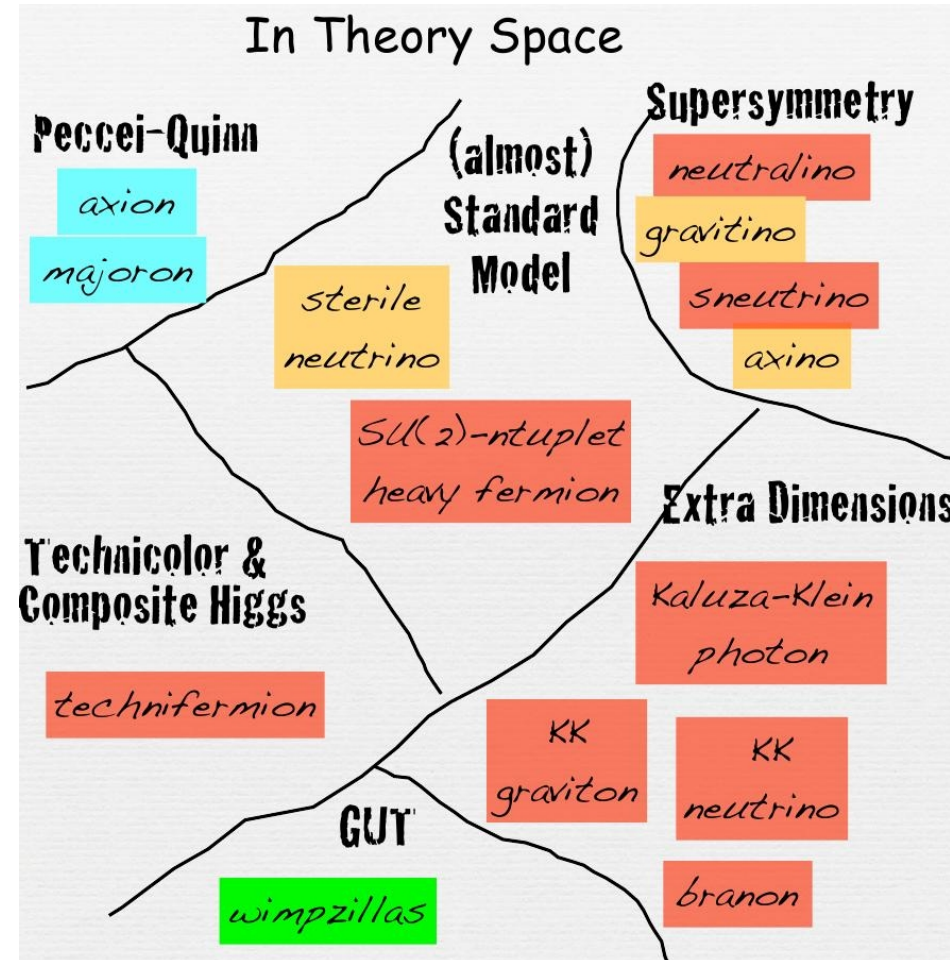
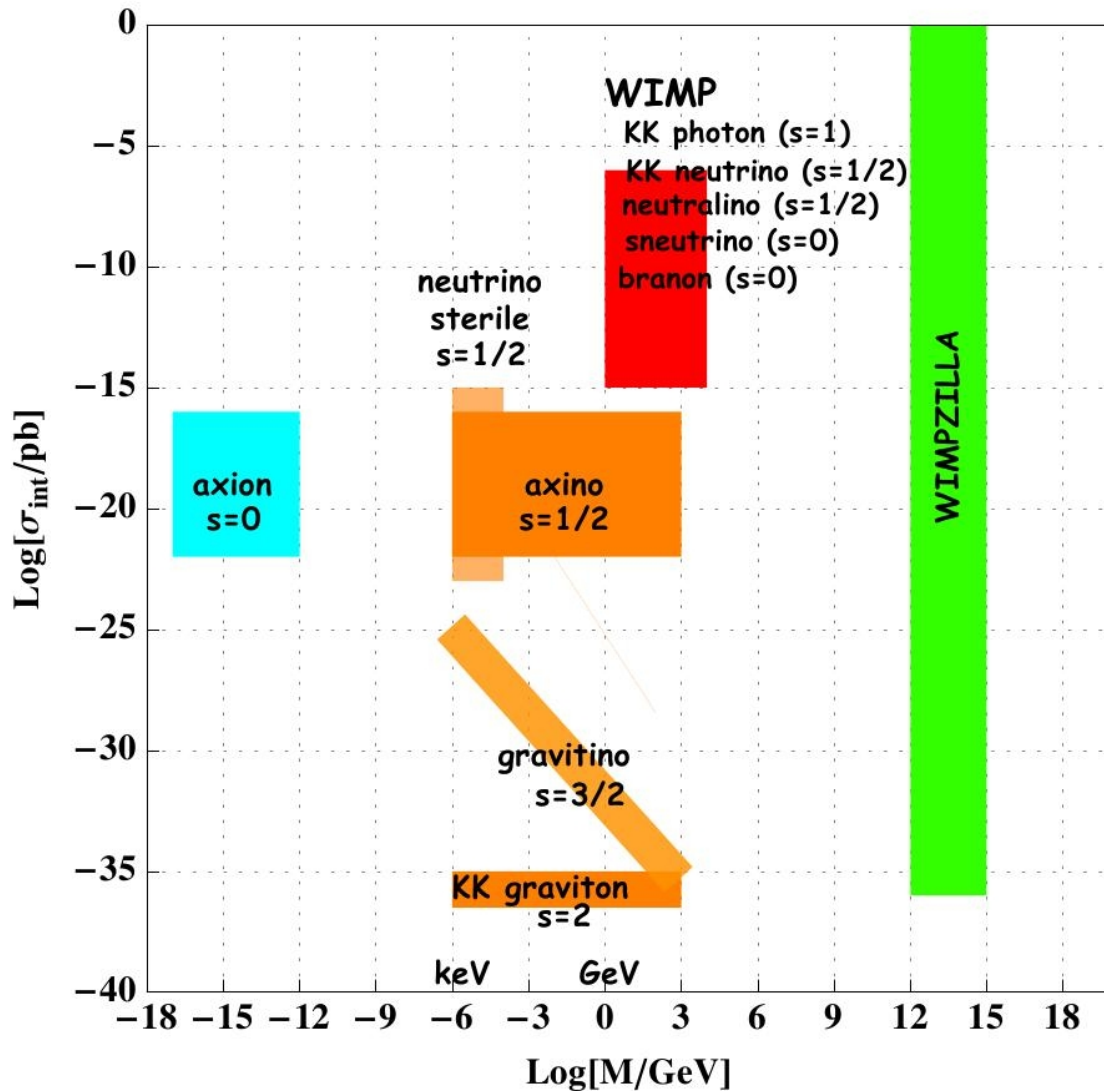

from G. Servant Talk EPS HEP 2013

back to CMSSM (for a short while for historical reason but not only !)

at $M_{\text{GUT}} \simeq 2 \times 10^{16}$ GeV :

- gauginos : $M_1 = M_2 = m_{\tilde{g}} = m_{1/2}$
- scalars : $m_{\tilde{q}_i}^2 = m_{\tilde{l}_i}^2 = m_{H_b}^2 = M_{H_t}^2 = m_o^2$
- trilinear soft terms : $A_b = A_t = A_o$
- radiative EWSB : $\mu^2 = \frac{m_{H_b}^2 - m_{H_t}^2 \tan^2 \beta}{\tan^2 \beta - 1} - \frac{m_Z^2}{2}$

⇒ five independent parameters

$$M_{1/2}, m_o, A_o, \tan \beta, \text{sgn}(\mu)$$

⇒ reminder :

neutralinos (and gluinos) are
Majorana fermions

R-parity is assumed to be conserved

at \sim EW scale : $M_3 = \frac{\alpha_3}{\alpha} \sin^2 \theta_W M_2 = \frac{3}{5} \frac{\alpha_3}{\alpha} \cos^2 \theta_W M_1$

$$M_3 : M_2 : M_1 \approx 7 : 2 : 1$$

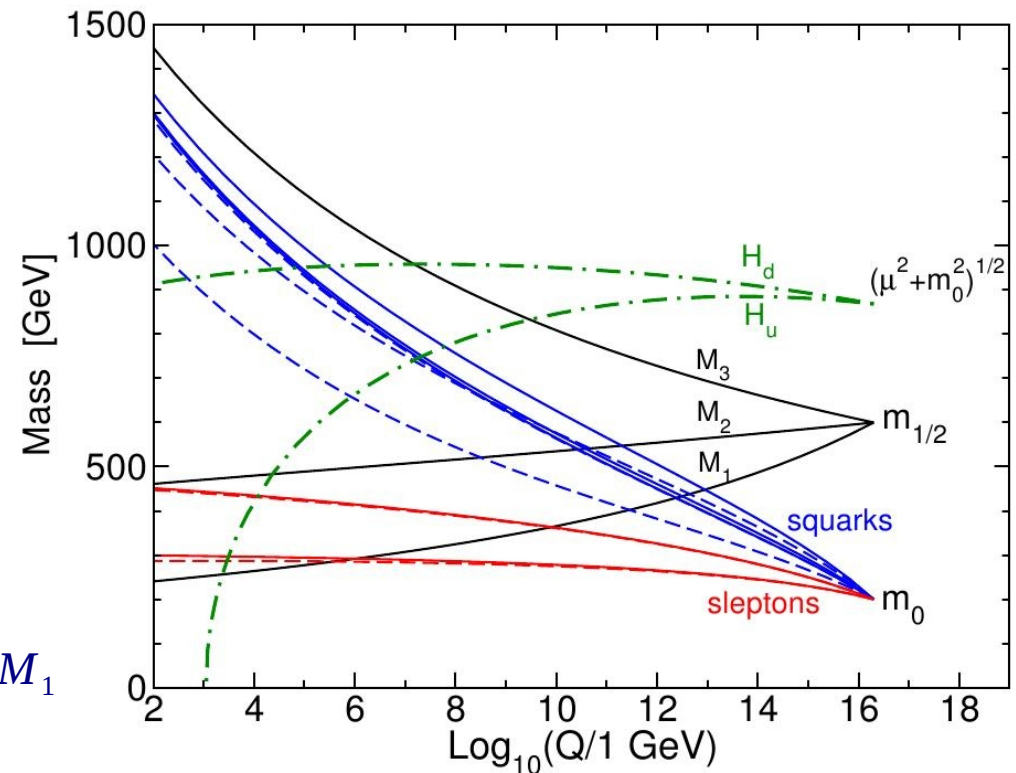

in MSSM

Neutralinos (i.e. Majorana fermions in MSSM - see later on for Dirac gauginos)

$$\tilde{\chi}_i^0 = N_{i,1} \tilde{B} + N_{i,2} \tilde{W}_3 + N_{i,3} \tilde{H}_d^0 + N_{i,4} \tilde{H}_u^0$$

Bino

Wino

Higgsinos

- lightest neutralino (i=1) $\tilde{\chi}_1^0$ often considered as LSP and a candidate for DM

- couplings of lightest neutralino (i=1) to Z boson and Higgs boson can vanish

when it is purely gaugino $N_{13}=N_{14}=0$ or purely higgsino $N_{11}=N_{12}=0$

Mass constraints on lightest Neutralino

Constraints on the mass of lightest neutralino from colliders come from LEP and usually assume CMSSM and combination of various susy searches

the 'would be' invisible Z boson decay constraint at $M_Z / 2$ does not hold since the lightest neutralino can decouple from the Z boson

PDG: $m_{\tilde{\chi}_1^0} > 46 \text{ GeV}$ (the most stringent constraints from colliders)

dashed curve :
assuming any m_0 no mixing in the 3rd generation

dot-dashed curve :
assuming any m_0 , allowing for mixing in the 3rd generation with $A_\tau = A_b = A_t = 0$

vertical solid line :
effect of h search in the max m_h scenario

vertical dashed line :
effect of h search in the no mixing scenario

the 49 GeV limit claimed in the refered paper is for m_0 up to 1 TeV, and h search in the max m_h scenario

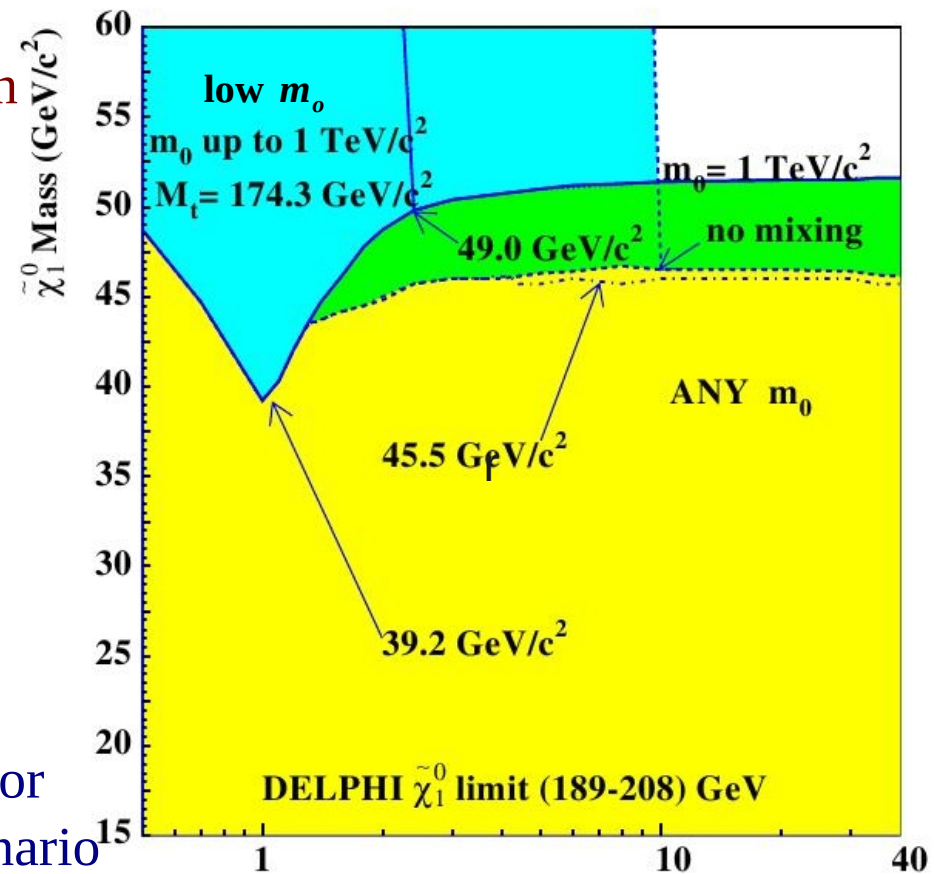

Dark Matter relic density : main annihilation channels at rest

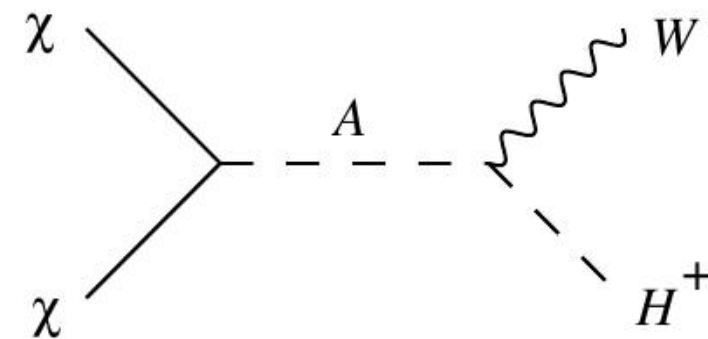
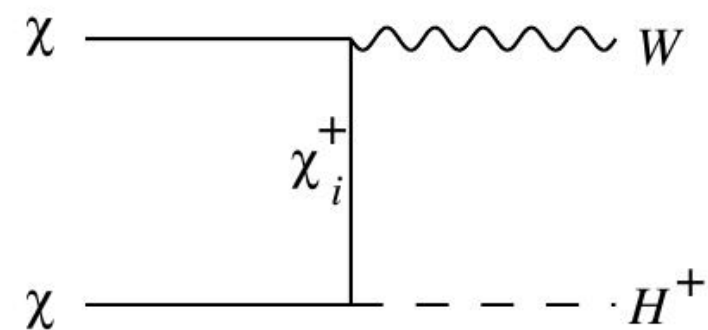
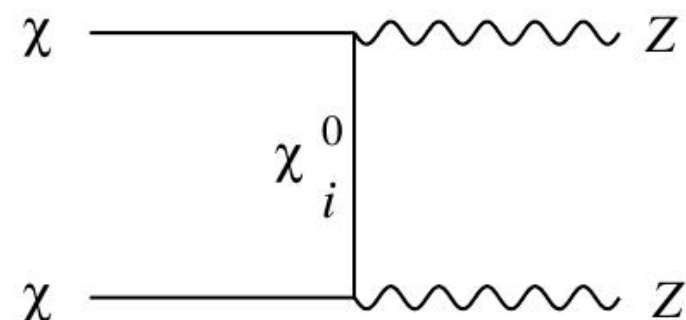
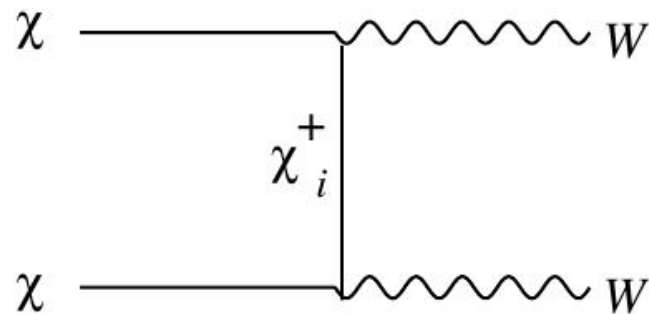
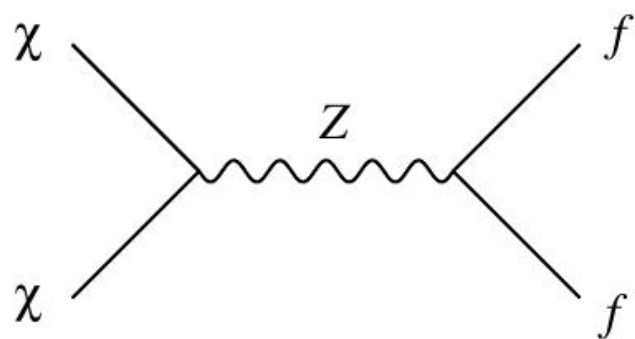
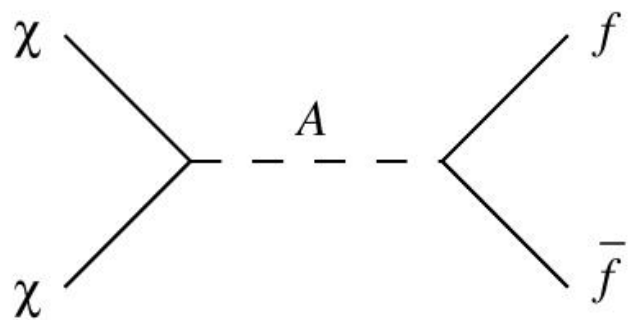
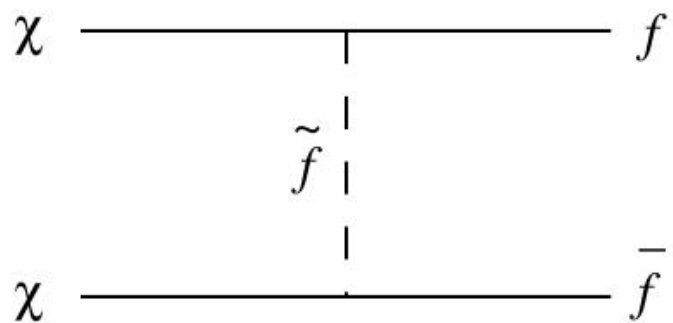

Dark Matter relic density: main annihilation channels at rest

(cont')

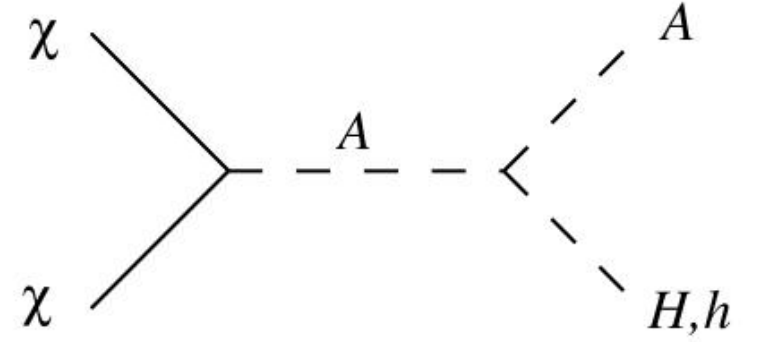
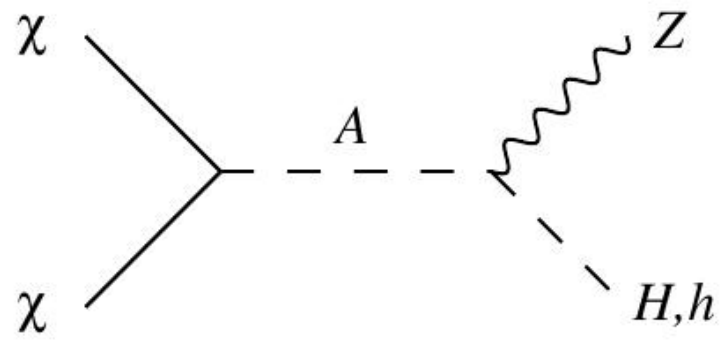
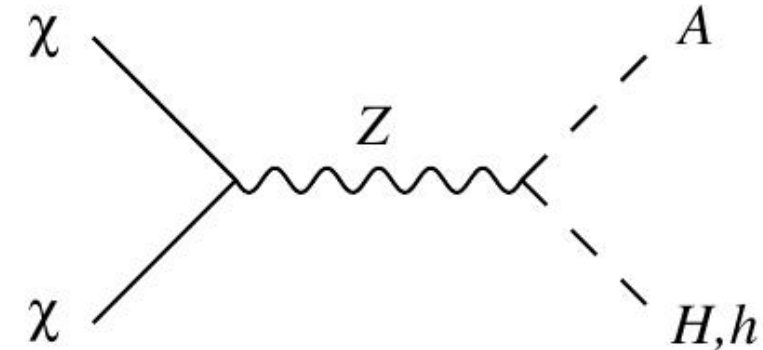
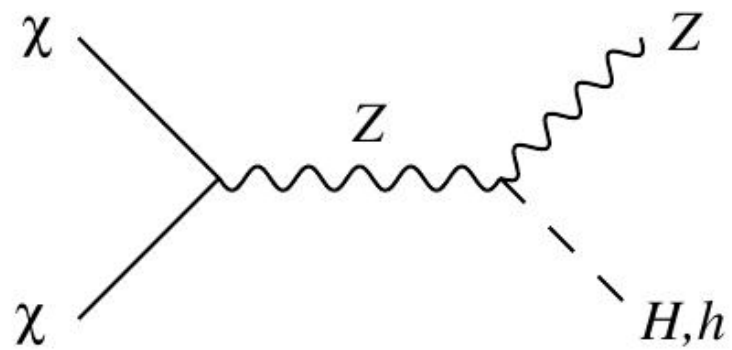
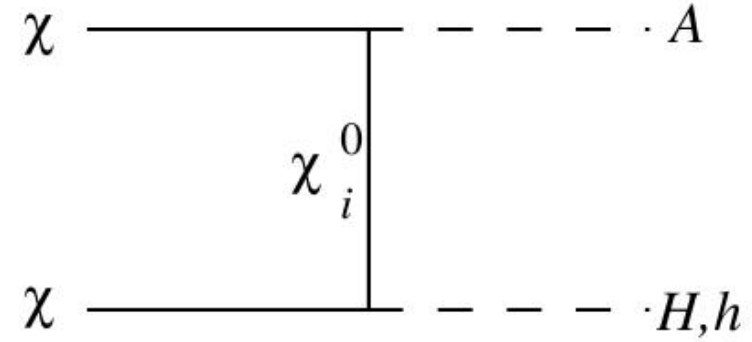
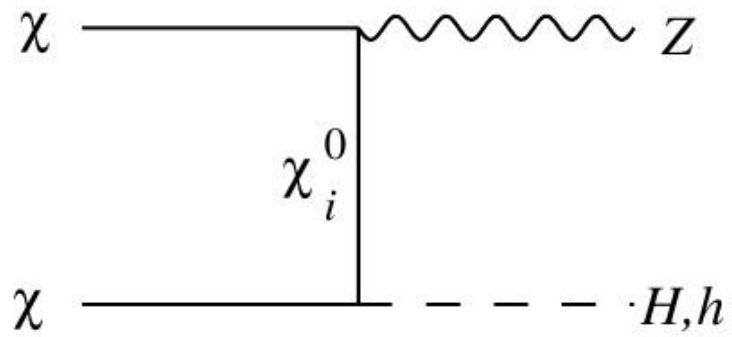

Example of relic density calculation

coannihilation region

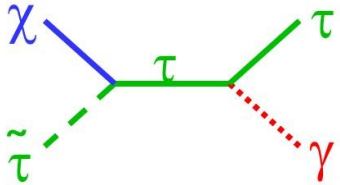

degenerate neutralino and stau

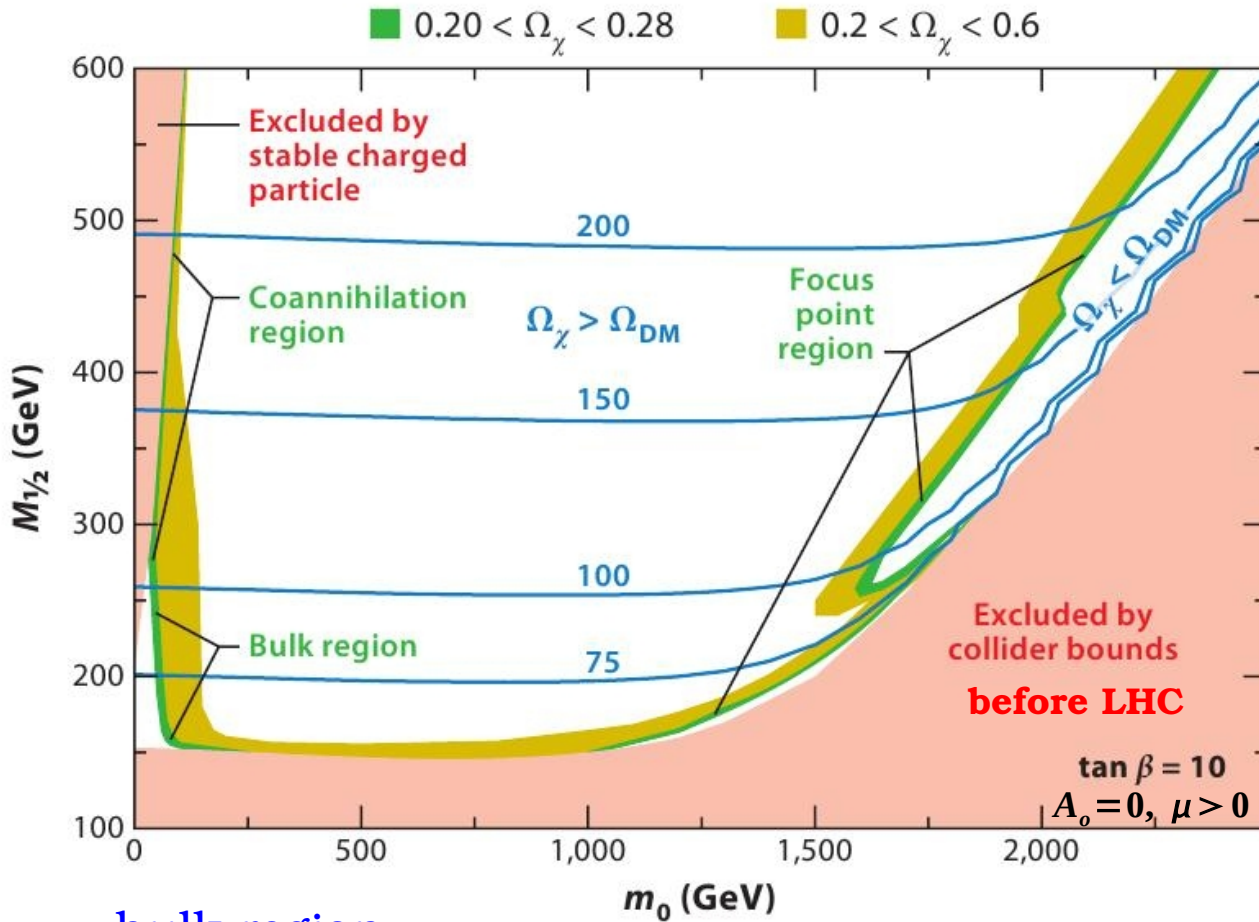

focus point region

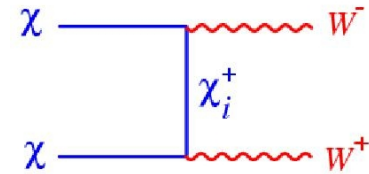

mixed higgsino-bino neutralinos

bulk region

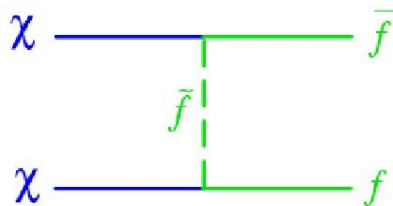

light sfermions

picture can change quite drastically at larger $\tan \beta$
 ex: s-channel annihilation via a A boson (funnel region)

interactions with matter (with nucleon quark)

because of the Majorana nature of the $\tilde{\chi}$ (i.e. $\tilde{\chi} \gamma^\mu \tilde{\chi} = 0$ and $\tilde{\chi} \sigma^{\mu\nu} \tilde{\chi} = 0$) the most general lagrangian at the level of quarks is described by the 4-fermion lagrangian :

$$L = \sum_i \left[d_i \tilde{\chi} \gamma^\mu \gamma^5 \tilde{\chi} \bar{q}_i \gamma_\mu \gamma^5 q_i + f_i \tilde{\chi} \tilde{\chi} \bar{q}_i q_i \right]$$

axial vector or spin dependent interactions

scalar or spin independent interactions

the scalar contribution is dynamically reduced w.r.t. the spin dependent one in models where the LSP is mostly a Bino one typically obtains :

$$\sigma_{\chi-p}^{SD} = 10^{-7} - 10^{-5} \text{ pb} \quad \text{for Spin Dependent (SD) cross sections}$$

$$\sigma_{\chi-p}^{SI} = 10^{-12} - 10^{-7} \text{ pb} \quad \text{for scalar or Spin Independent (SI) cross sections}$$

candidate “direct” interactions (with nucleon quark)

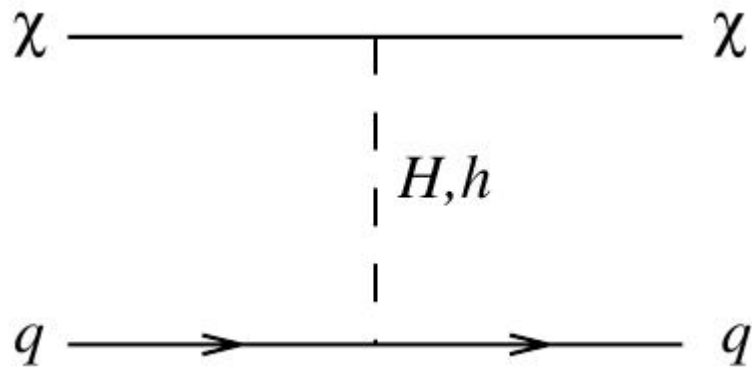

Scalar (SI)

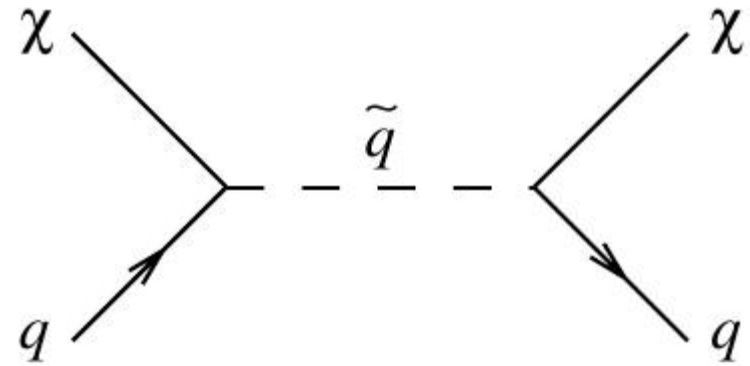

scalar and spin dependent

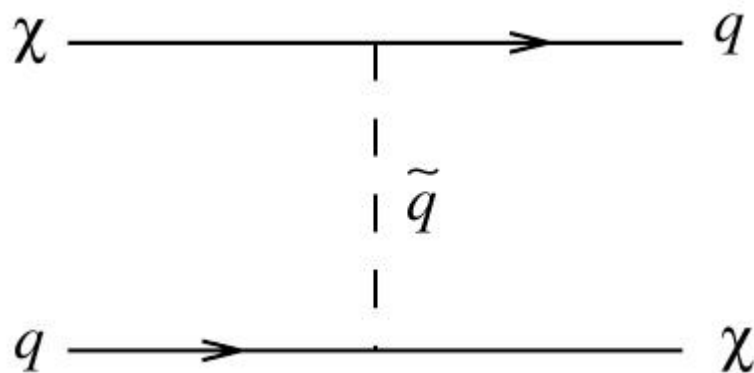

scalar and spin dependent

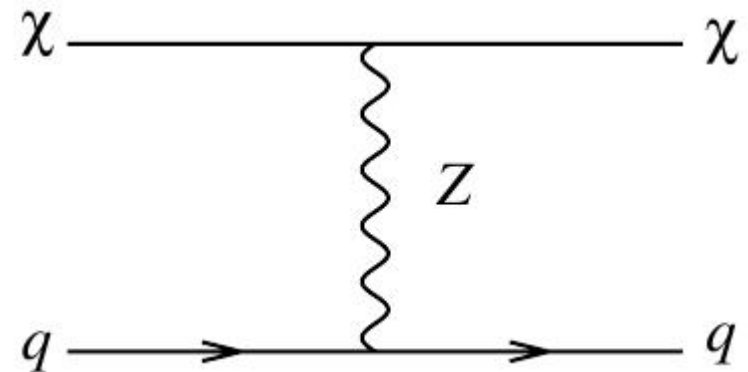

spin dependent (SD)

scalar and spin dependent interaction of the lightest neutralino $\tilde{\chi}_1^0$ with matter
 the exchange of a sfermion in the s or t channel leads to both type of interactions

Dark Matter direct detection

WIMPs can potentially scatter with nuclei through both **spin independent** and **spin-dependent** interactions

the experimental sensitivity to **spin-independent** couplings benefits from coherent scattering which leads to cross sections and rates proportional to the square of the atomic mass of the target nuclei

the cross section for **spin-dependent** scattering, in contrast, are proportional to $J(J+1)$ where J is the spin of the nucleus and thus do benefit from large target nuclei

as a result the current experimental **sensitivity to spin-dependent** scattering is **below** that of **spin independent** scattering of WIMPs with nuclei

Where is dark matter ?

- the WIMP miracle (reminder)

 - back to MSSM

 - relic density

 - interaction with matter

- **some recent non-accelerator experimental results (summer 13')**

- some global fits

 - CMSSM (frequentist and Bayesian)

 - beyond CMSSM and MSSM

- invisible Higgs

- 2 examples from extra dimensions

- asymmetric DM

- effective field theory approaches (and limitations)

- possible searches at lepton colliders

Dark Matter direct detection

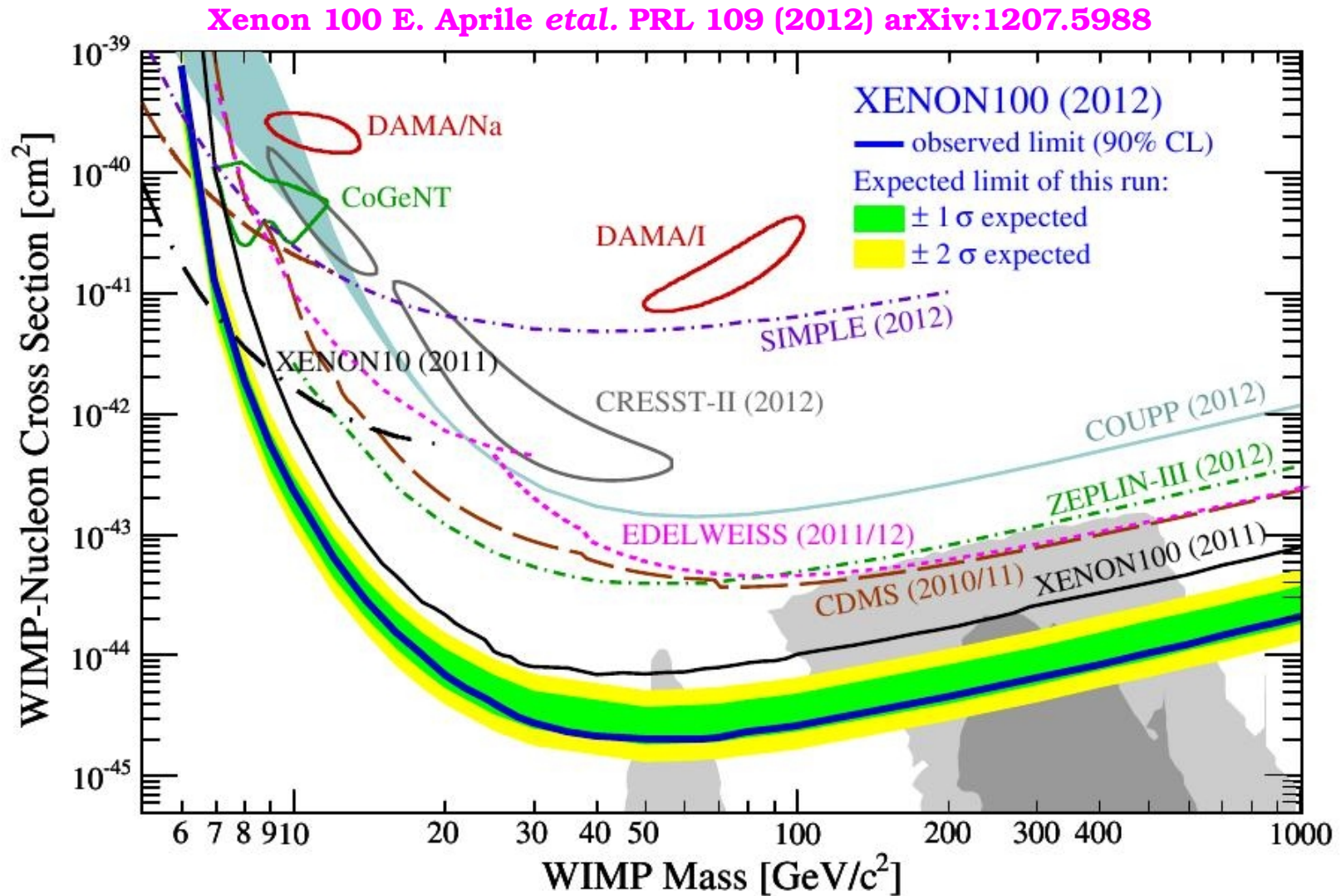

pure Wino or pure Higgsino state Neutralinos have vanishing coupling to Higgs
however they can be probed by indirect detection

Dark Matter direct detection

Projection for XENON 1 T

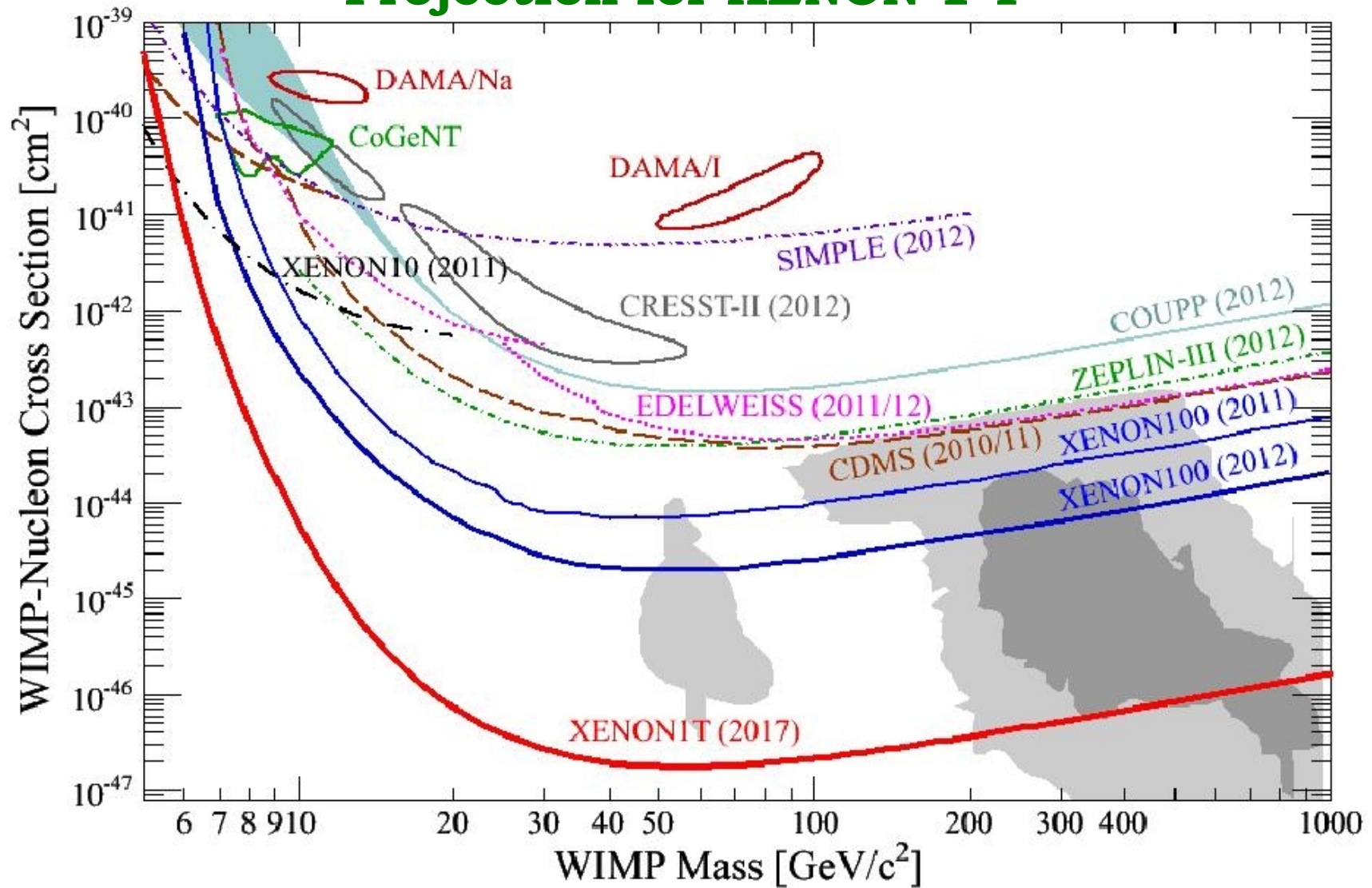

Goal : $\sigma = 2 \times 10^{-47} \text{ cm}^2$ at 50 GeV WIMP mass by 2017

XENON100 : $\sigma = 2 \times 10^{-45} \text{ cm}^2$ at 55 GeV WIMP mass

Dark Matter direct detection

DAMA, CoGent, Cressst and CDMS claim a signal in the low mass region

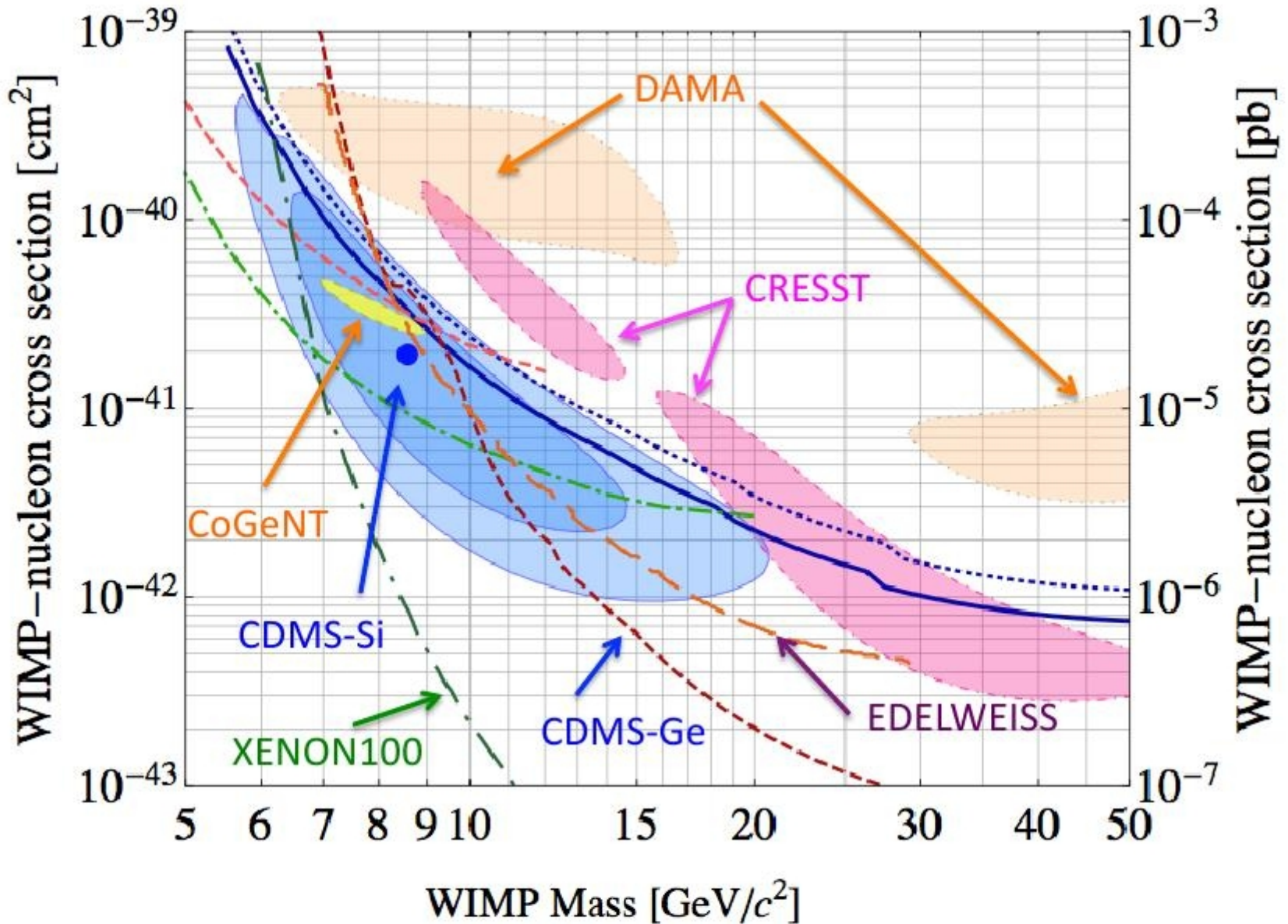

CDMS-Si best fit point $m_\chi = 8.6 \text{ GeV}$ and $\sigma_\chi = 1.9 \times 10^{-41} \text{ cm}^2$

Dark Matter direct detection

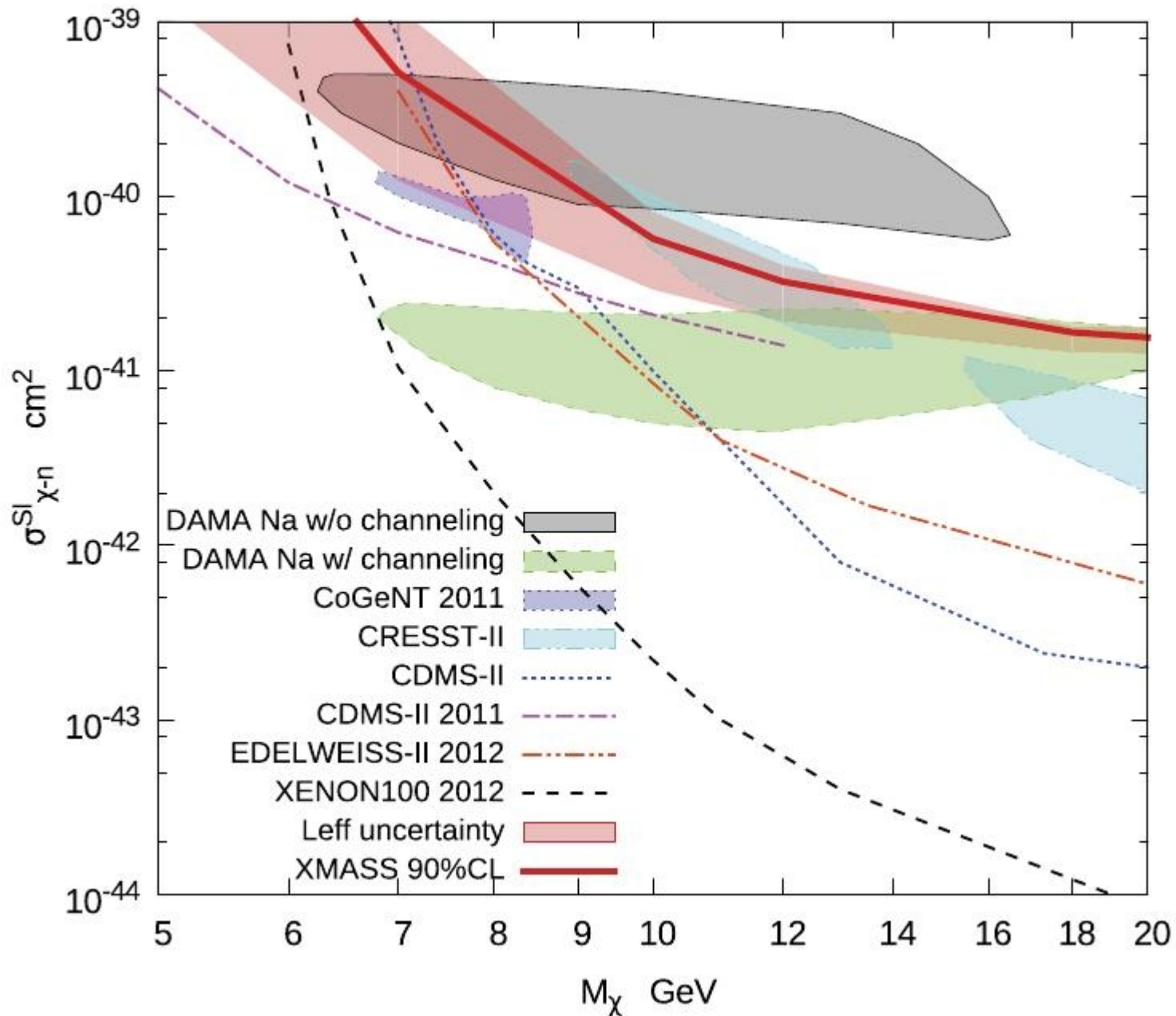

from XMASS K. Abe *etal.* PLB 719 (2013) 78

Dark Matter direct detection

Contribution from IceCube → strongest constraints on SD Xsection

SD WIMP-proton cross-section limit

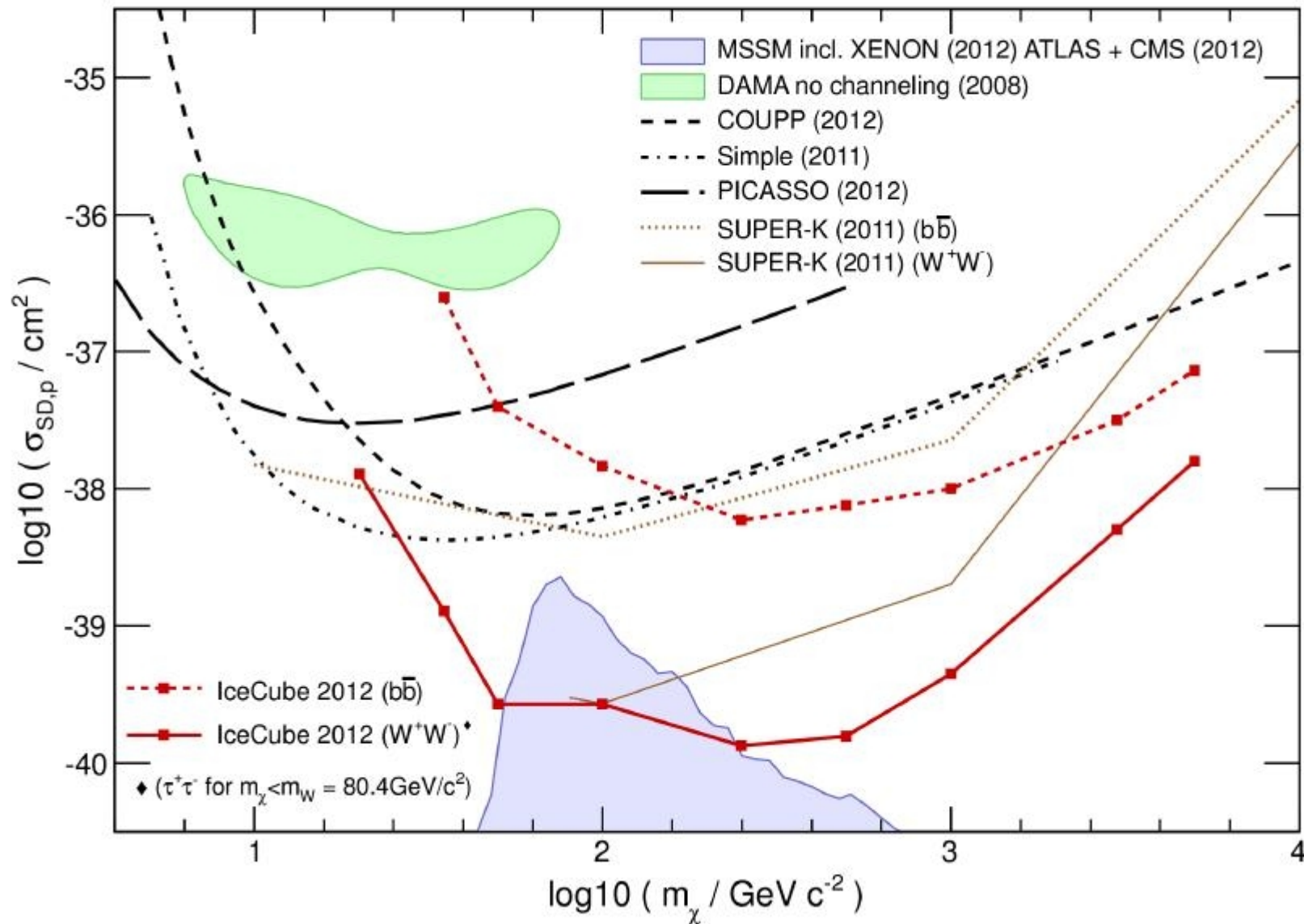

Dark Matter indirect detection

$$\tilde{\chi} \tilde{\chi} \rightarrow t \bar{t}, b \bar{b}, c \bar{c}, \tau^+ \tau^-, \dots, W^+ W^-, ZZ$$

and secondary particles as neutrinos, photons, positrons ...

in particular annihilation of neutralinos in the halo can be characterized by :

- monoenergetic photons through the 1-loop processes $\tilde{\chi} \tilde{\chi} \rightarrow \gamma \gamma, \gamma Z$

$$E_\gamma = M_{DM} \left[1 - \left(\frac{M_Z}{2 M_{DM}} \right)^2 \right]$$

- continuous spectrum of photons through the decay of annihilation product mostly from the decay of π^0 produced in hadronization

- nearly monoenergetic positrons (from direct annihilation)

- 'soft' positrons (from π^+, τ^+, μ^+ decay)

Dark Matter indirect detection

Fermi two-year all-sky map

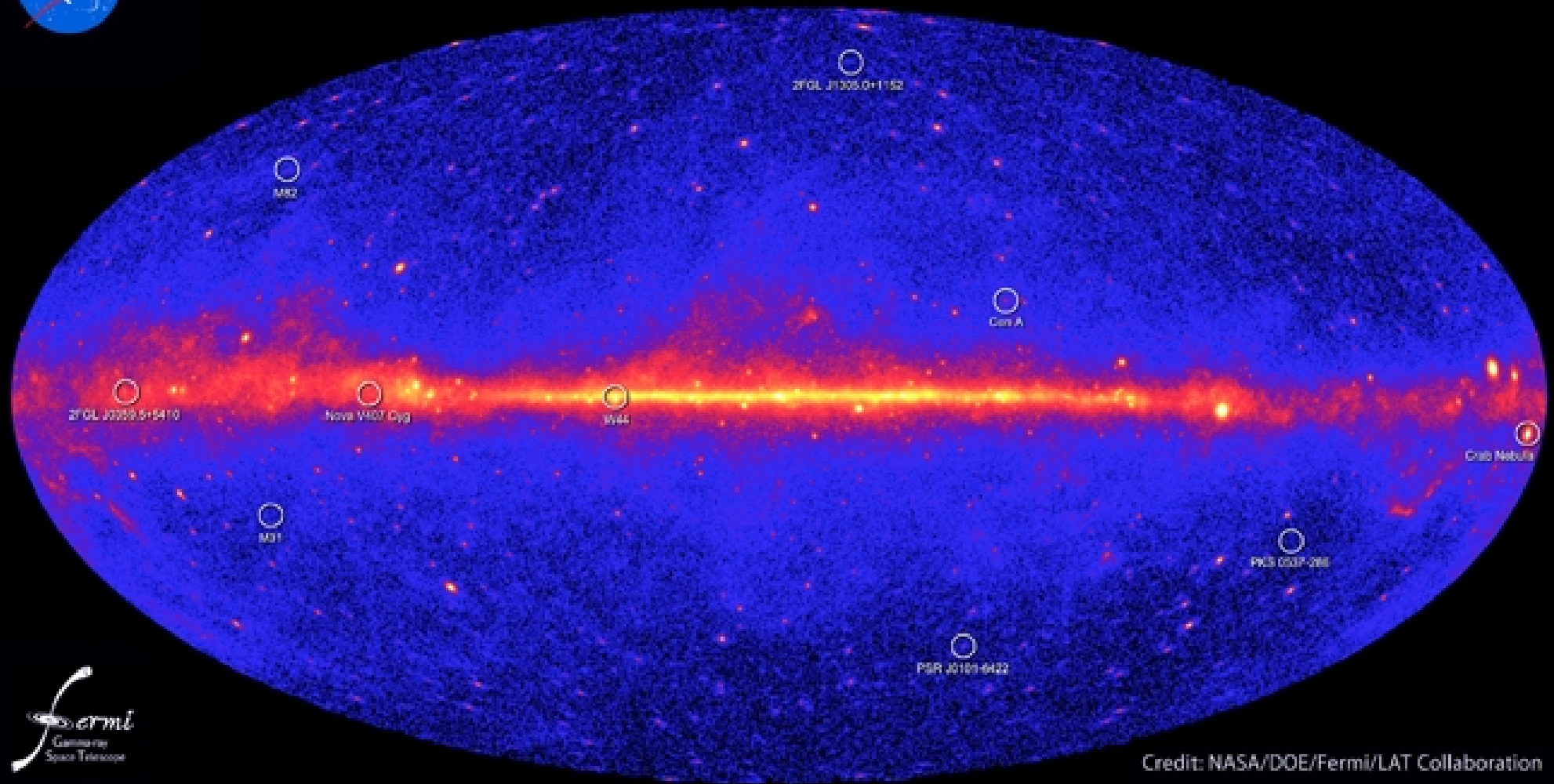

Dark Matter indirect detection

Observation of a line in the galactic center ?

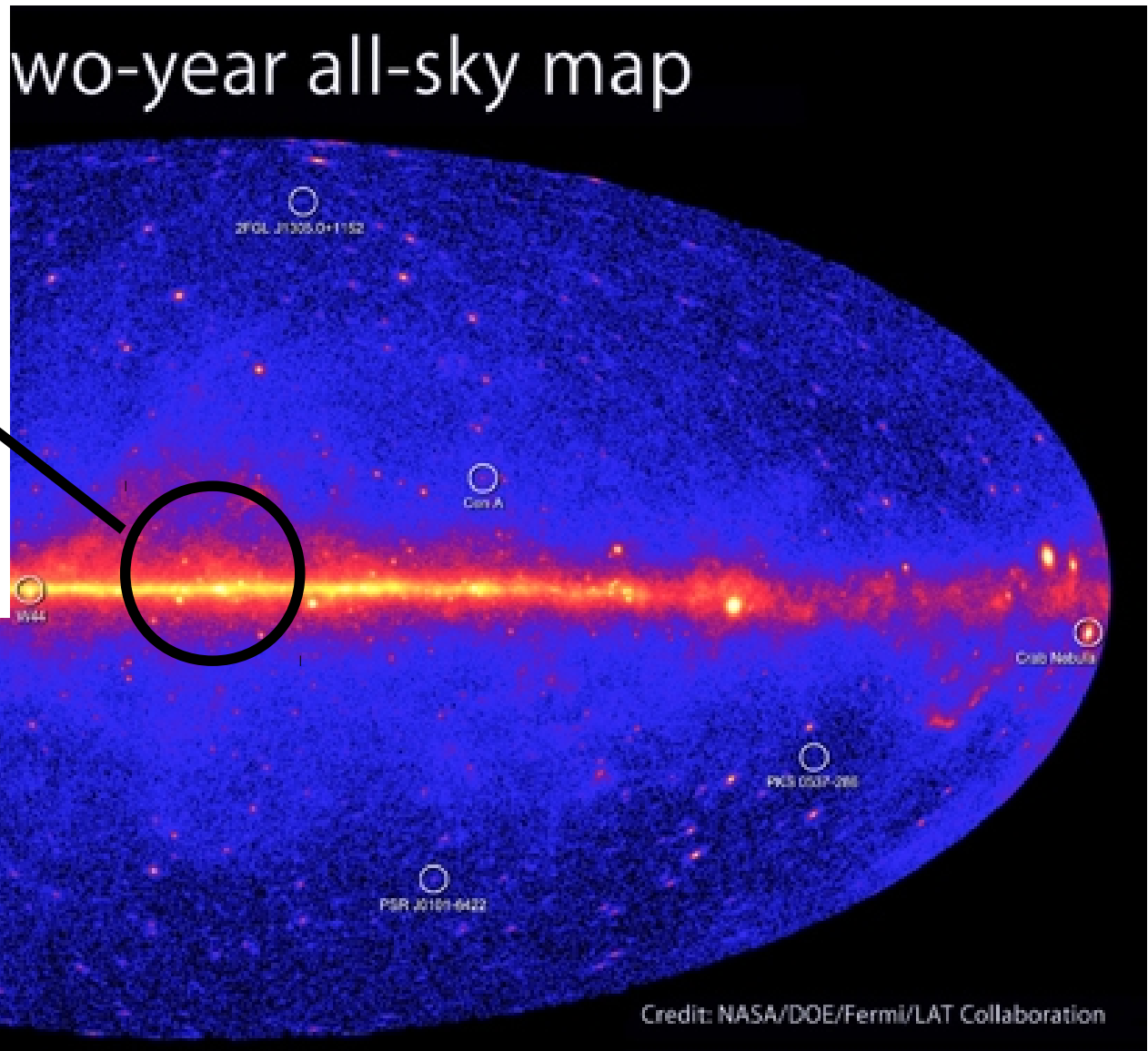
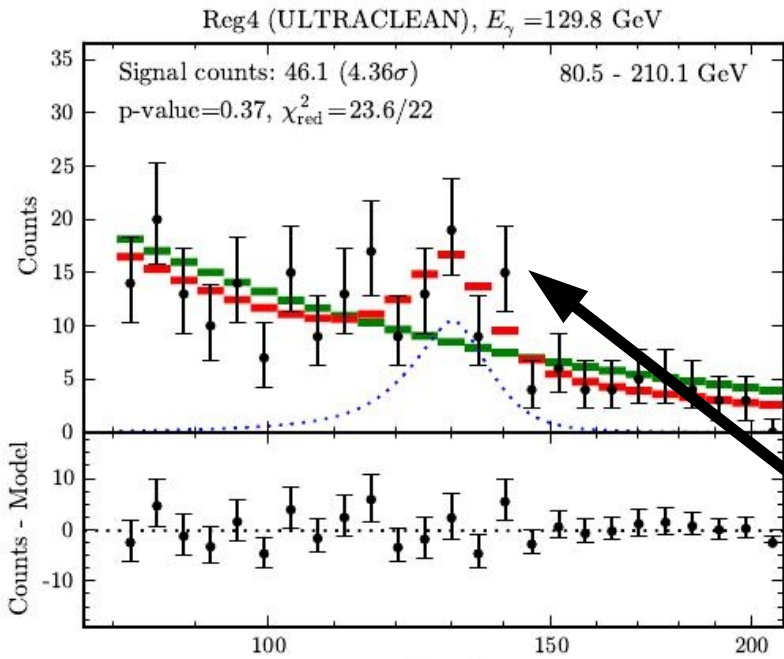

Jcap 1208(2012)007E [GeV]



Dark Matter indirect detection

Observation of a line in the galactic center ?

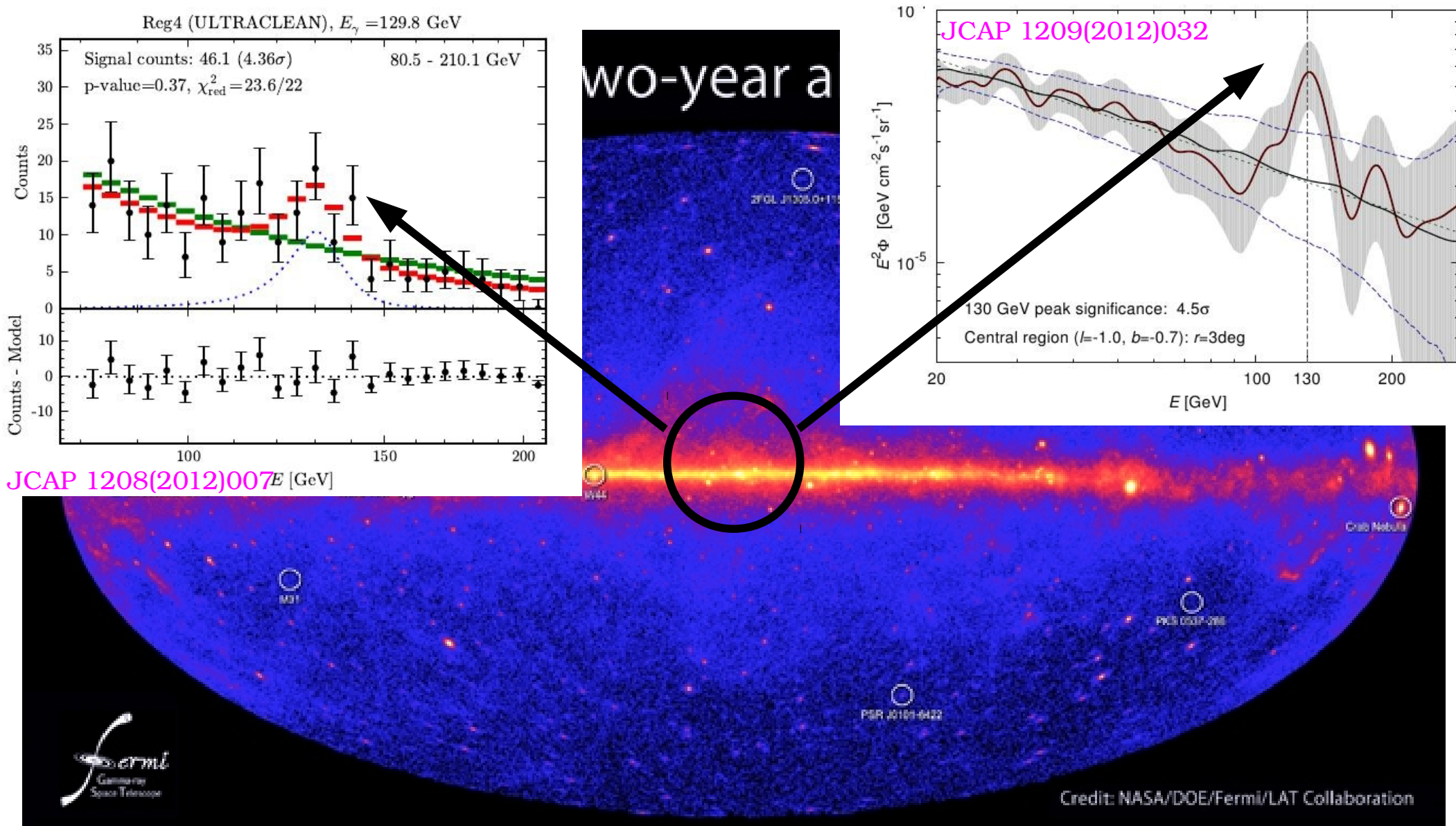

Dark Matter indirect detection

Observation of a line in the galactic center ?

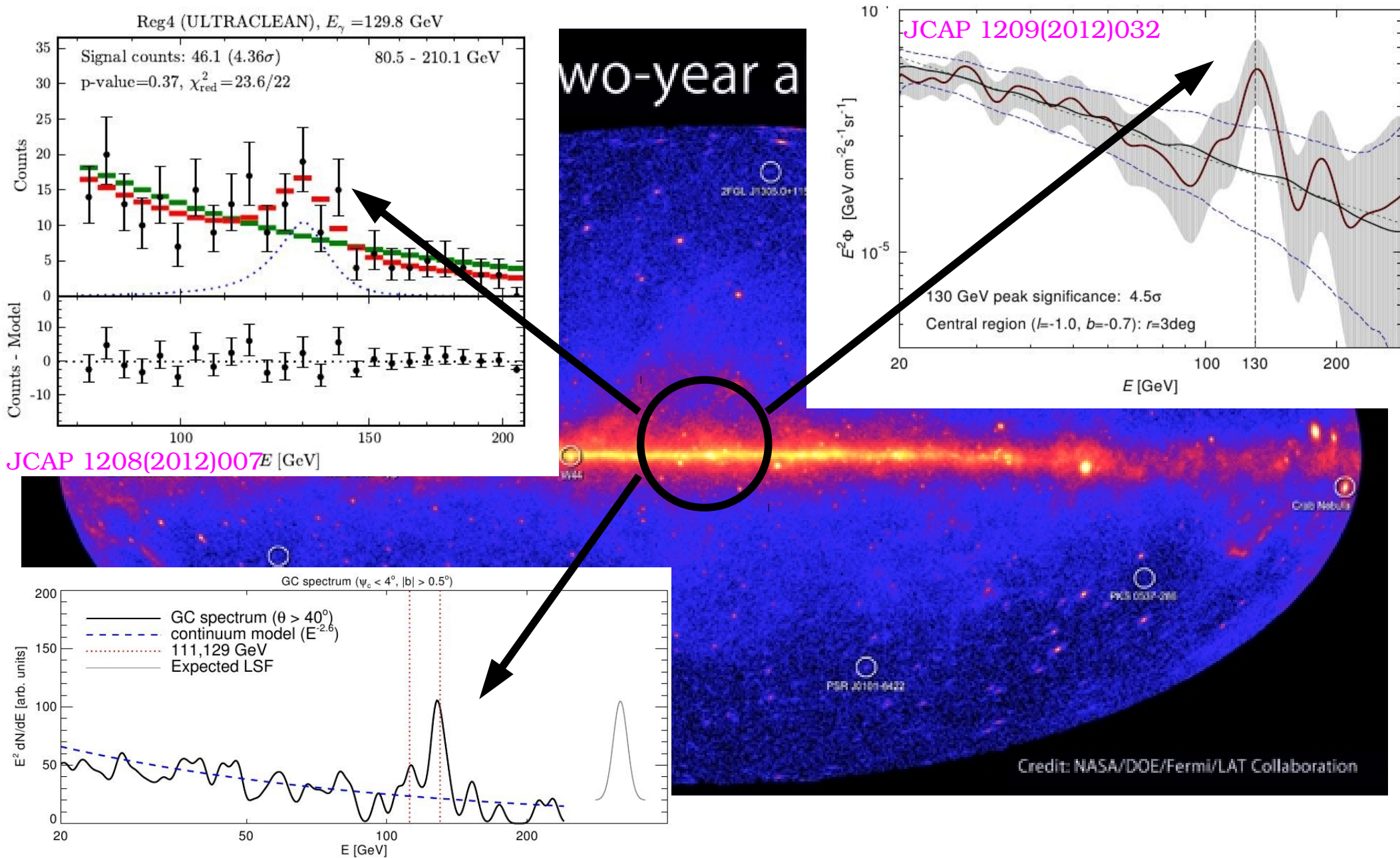

Dark Matter indirect detection

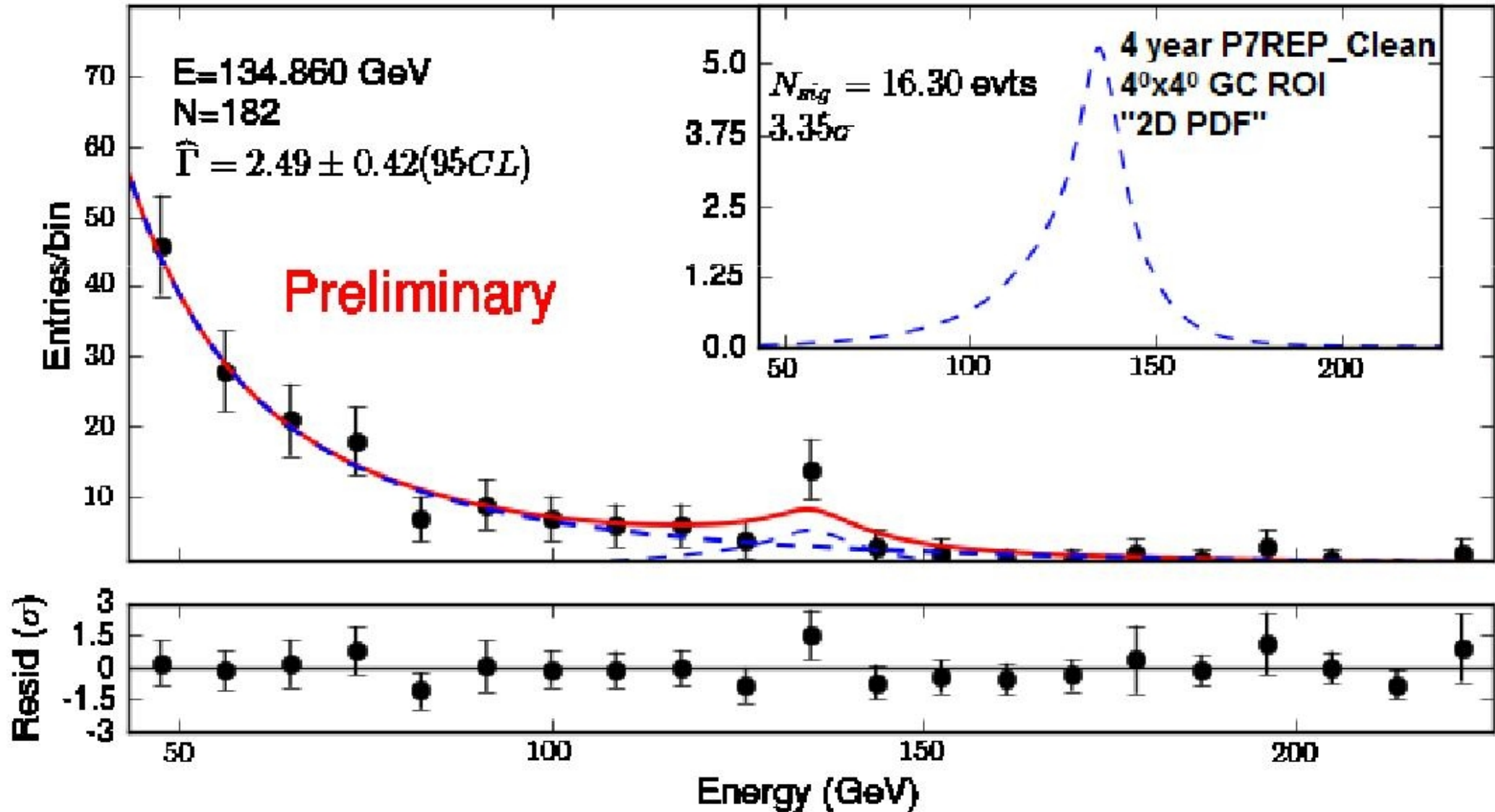

FERMI-LAT team
line search with 3.7 year
reprocessed data (last october)



3.35 σ (local)
<2 σ global significance

Dark Matter indirect detection

upper limit on DM annihilation Xsection into lepton from AMS2 results

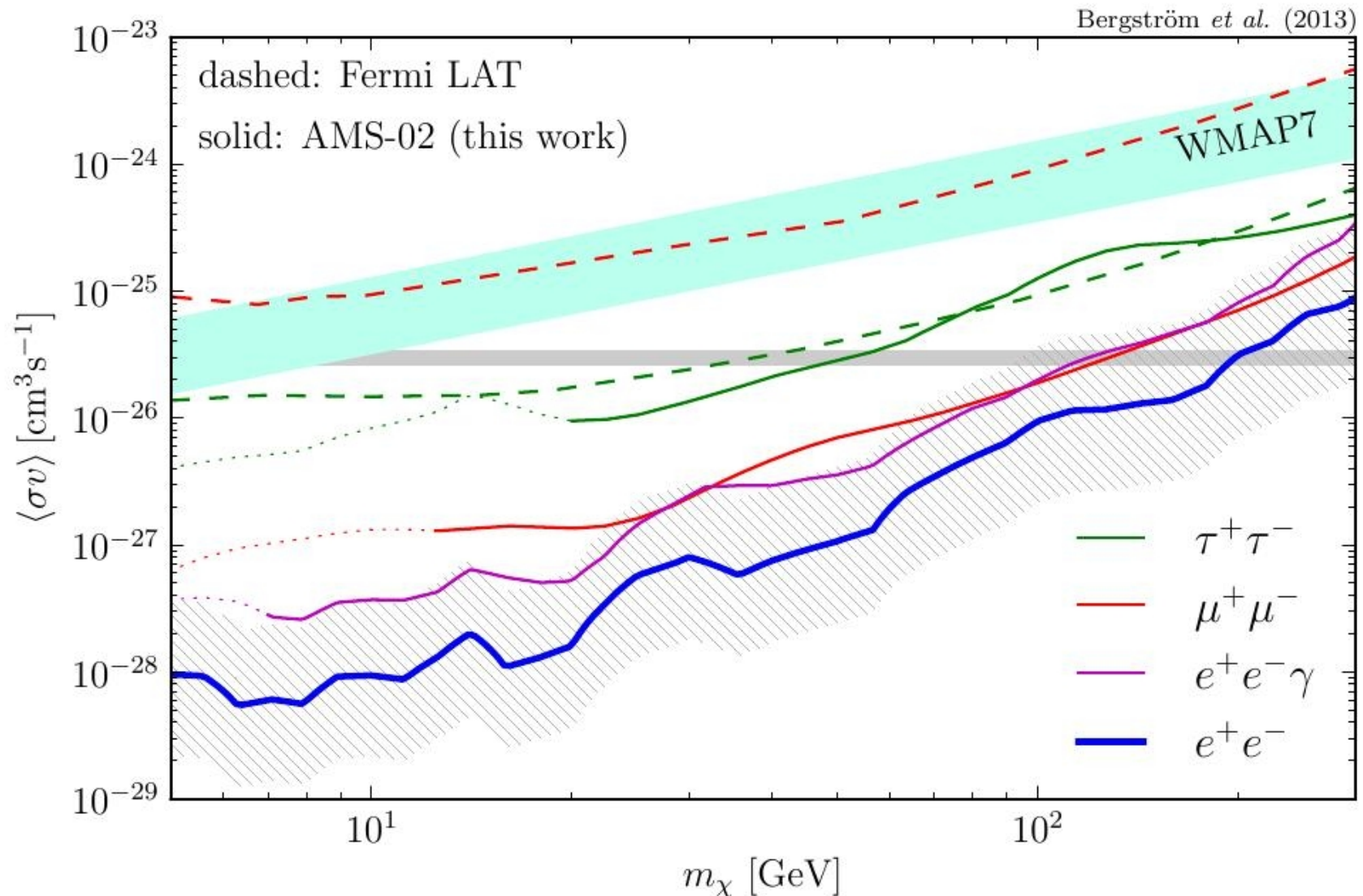

Bergstrom, Bringmann, Cholis, Hooper, Weniger, arXiv 1306.3983

Where is dark matter ?

- the WIMP miracle (reminder)

 - back to MSSM

 - relic density

 - interaction with matter

- some recent non-accelerator experimental results (summer 13')

- **some global fits**

 - CMSSM (frequentist and Bayesian)**

 - beyond CMSSM and MSSM**

- invisible Higgs

- 2 examples from extra dimensions

- asymmetric DM

- effective field theory approaches (and limitations)

- possible searches at lepton colliders

Dark Matter : global fit “MasterCode”

SUSY: scattering cross section on nucleons down to $\sim 10^{-48} \text{ cm}^2$ (10^{-13} pb)

example with CMSSM after LHC 5 fb^{-1} , XENON 100 and $B_s \rightarrow \mu^+ \mu^-$

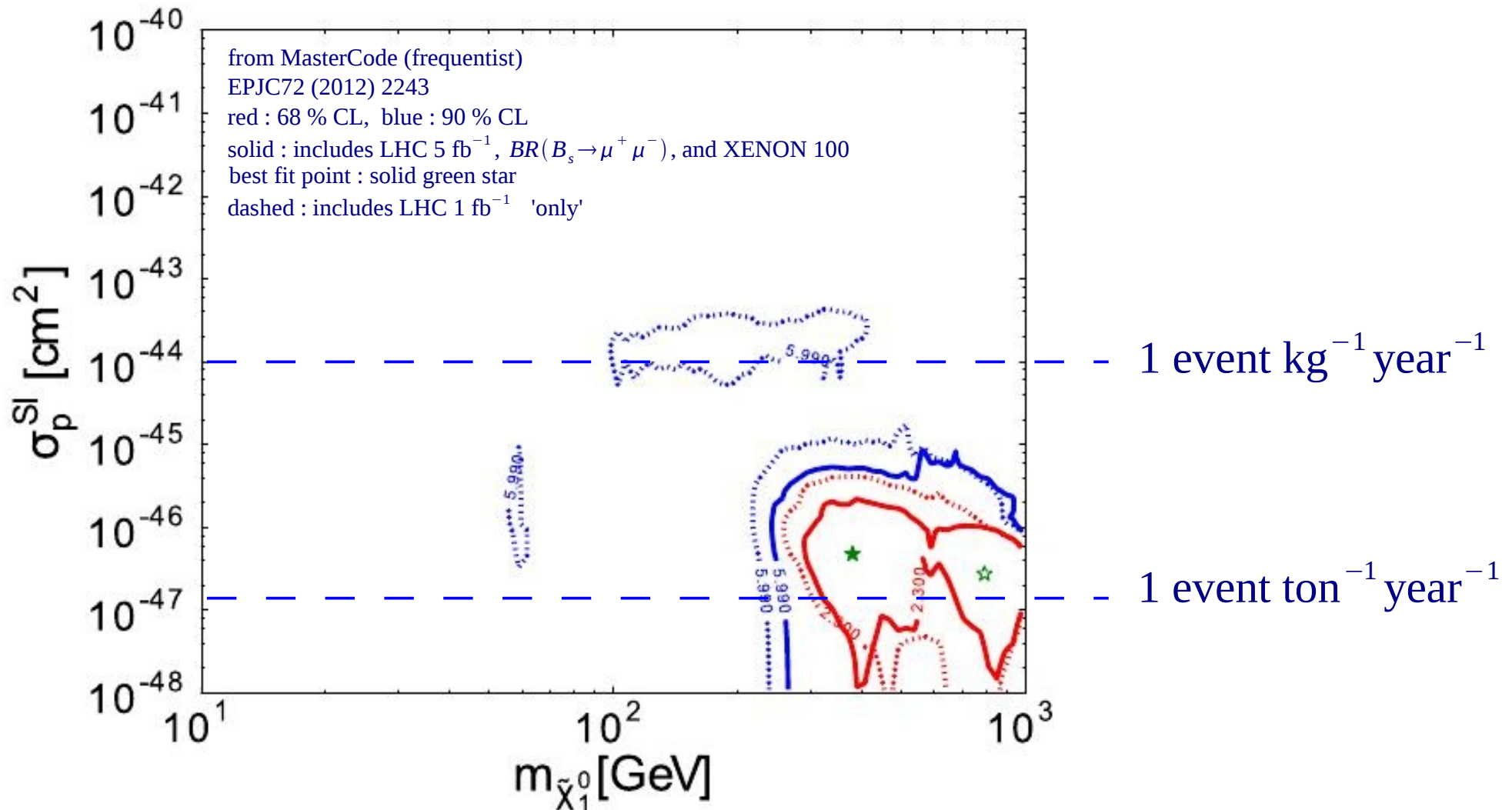

Dark Matter “ global fit “BayesFITS”



CMSSM and 1-tonne DM detectors

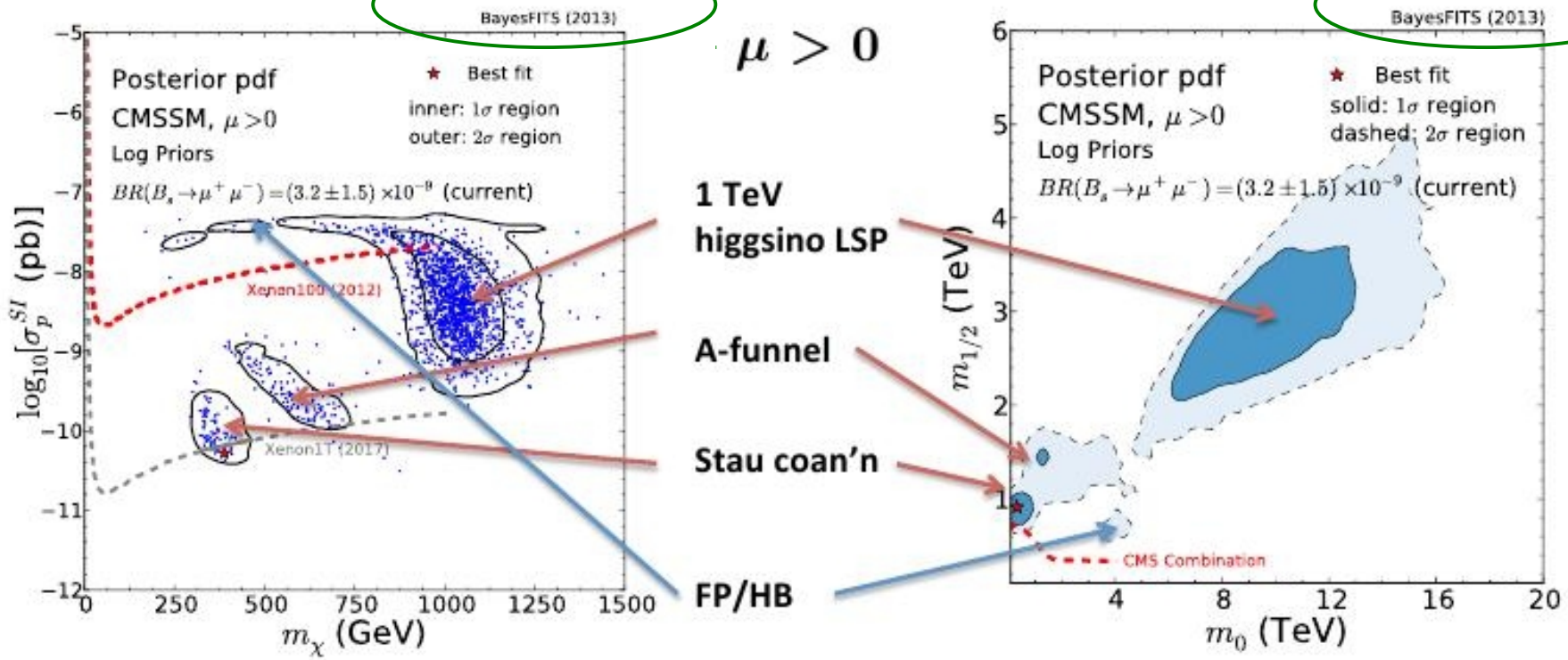

1-tonne DM detectors to cover most of CMSSM predictions

Dark Matter “ global fit “BayesFITS”

if $BR(B_s \rightarrow \mu^+ \mu^-) \simeq SM$ value with 5-10% precision \Rightarrow A funnel region gone

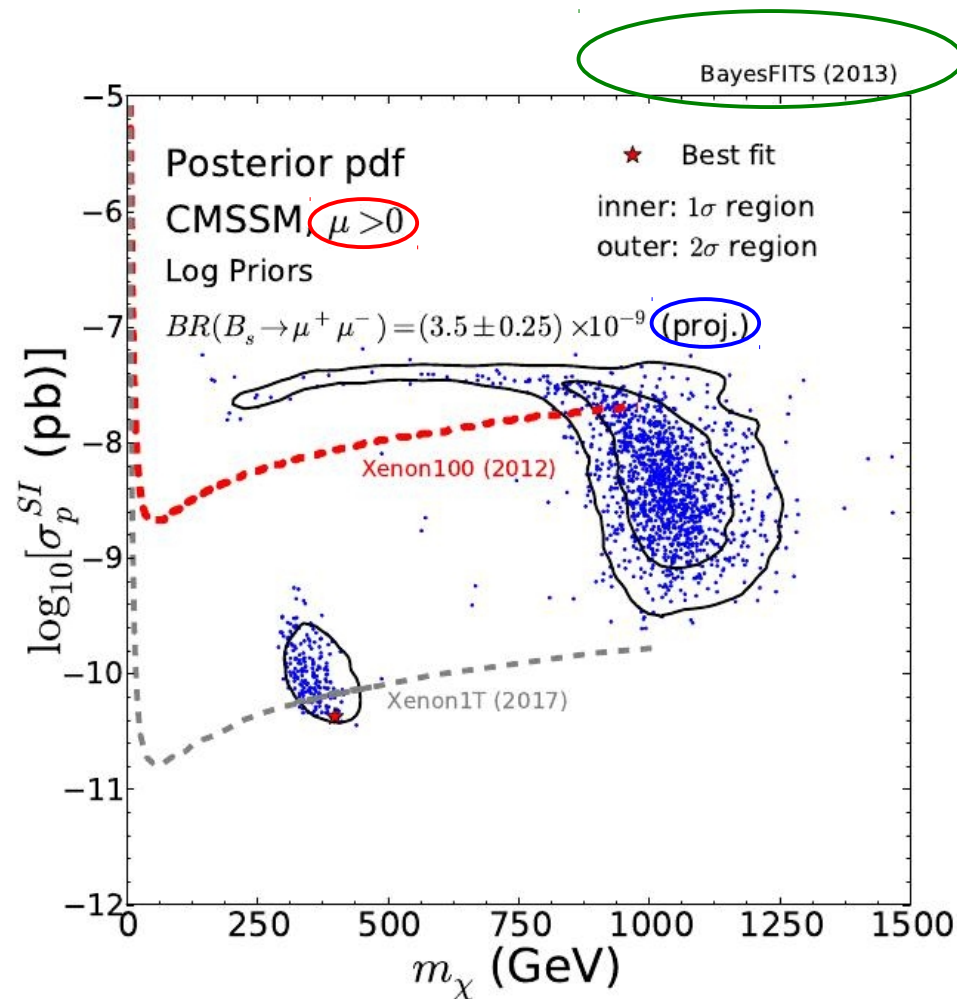
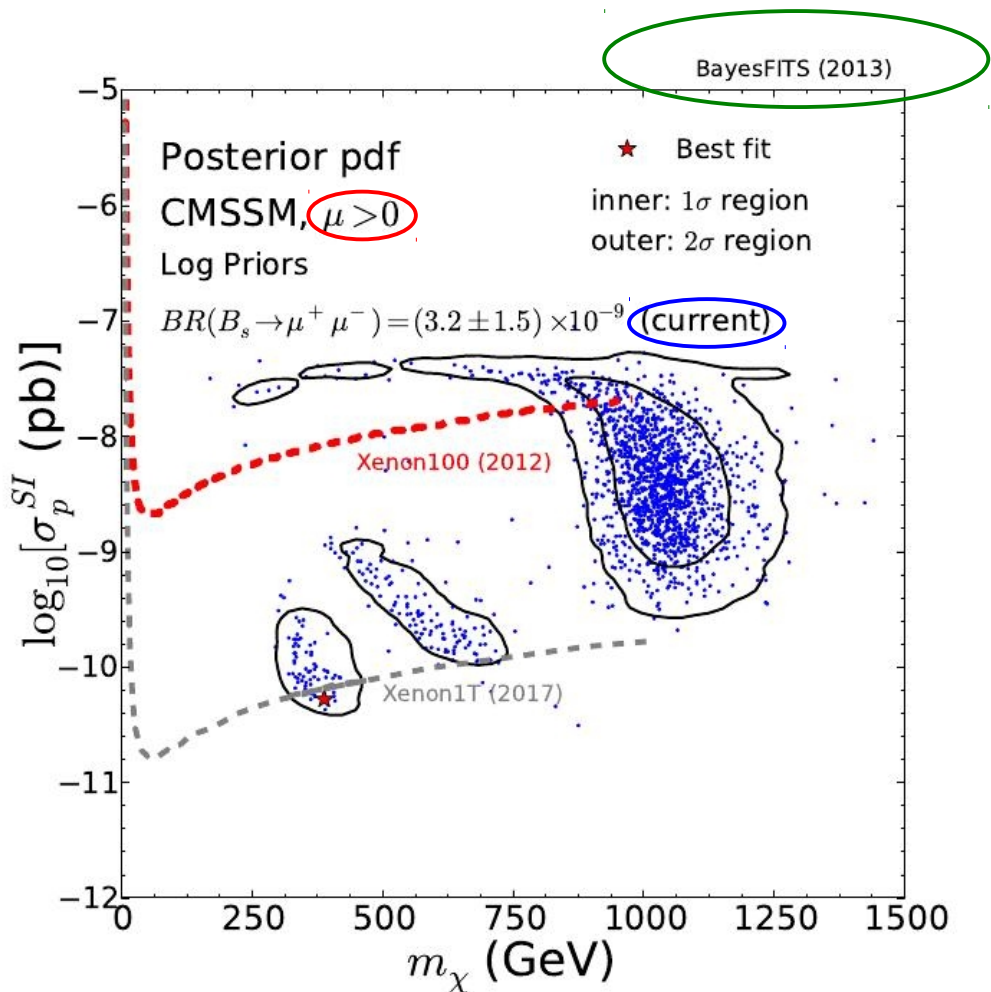

ways to rule out CMSSM (with $\mu > 0$) :

- no DM signal in 1 ton detectors
- DM signal at ~ 500 -750 GeV

situation changes a bit for $\mu < 0$
 (see next slide)

from Roszkowski talk Moriond QCD 2013

Dark Matter “ global fit “BayesFITS”

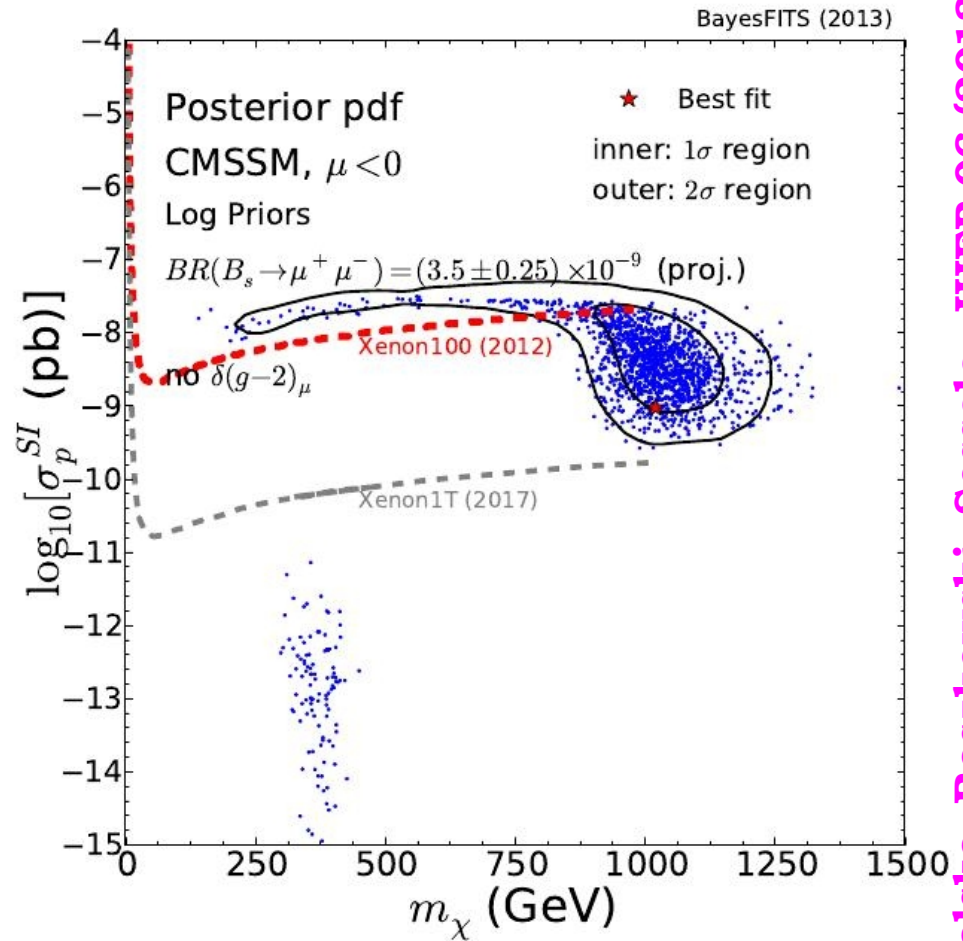
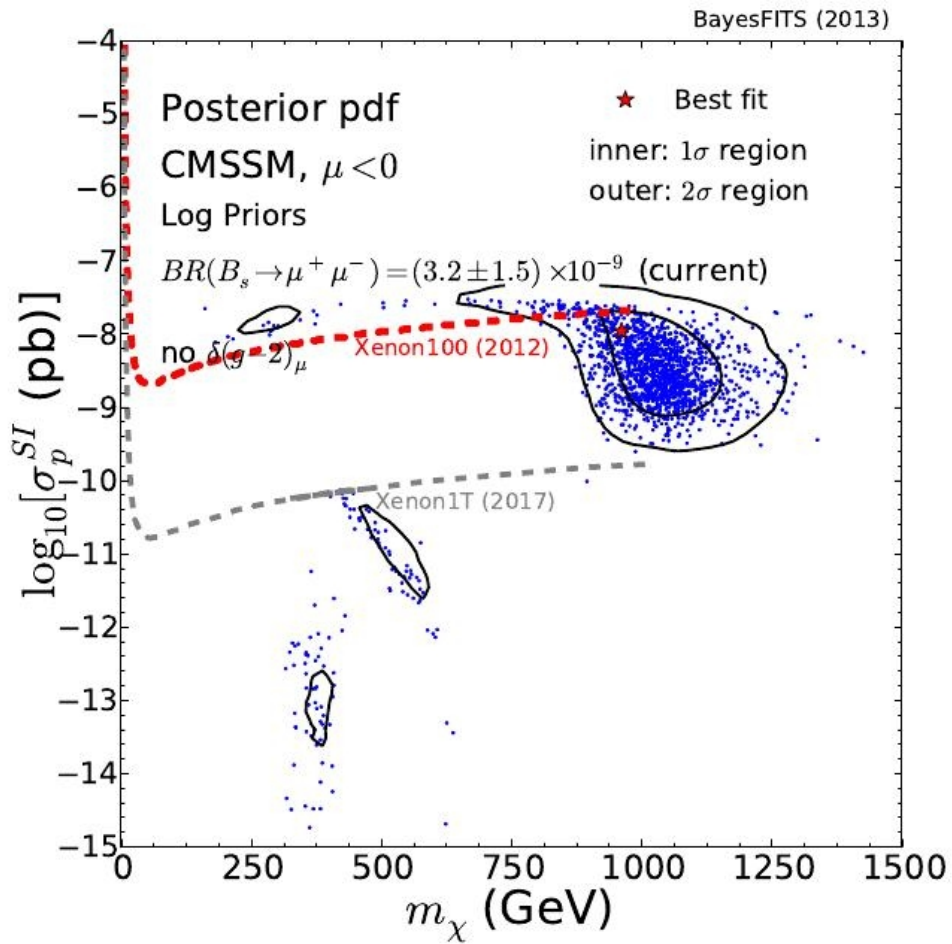

Dark Matter : beyond CMSSM

one can now depart from CMSSM often considered as too restrictive

⇒ 2 examples of alternatives:

example 1 : 'non universal Higgs mass models' NUHM
i.e. one or two non-universal supersymmetry-breaking
parameters contributing to the Higgs masses (NUHM1,2)

example 2 : 'phenomenological MSSM' pMSSM i.e. a MSSM version
without the 100++ parameters but a subsample of them
with no assumption at high scale but assuming :

- CP-conserving MSSM (no new CP phases)
- MFV
- first two generations of sfermions degenerate

19 parameters in pMSSM

Dark Matter : beyond CMSSM → NUHM

example 1 : 'non universal Higgs mass models' NUHM

i.e. one or two non-universal supersymmetry-breaking parameters contributing to the Higgs masses (NUHM1,2)

NUHM parameter	Description	Prior Range	Prior Distribution
m_0	Universal scalar mass	0.1, 4 (0.1, 20 [*])	Log (Linear)
$m_{1/2}$	Universal gaugino mass	0.1, 4 (0.1, 10)	Log (Linear)
A_0	Universal trilinear coupling	-7, 7 (-20, 20)	Linear
$\tan \beta$	Ratio of Higgs vevs	15, 35 (3, 62)	Linear
$\text{sgn } \mu$	Sign of Higgs parameter	+1 or -1	Fixed
m_{H_u}	GUT-scale soft mass of H_u	0.1, 4 (0.1, 20)	Linear
m_{H_d}	GUT-scale soft mass of H_d	0.1, 4 (0.1, 20)	Linear
Nuisance parameters like in the CMSSM			

Dark Matter : beyond CMSSM \rightarrow NUHM

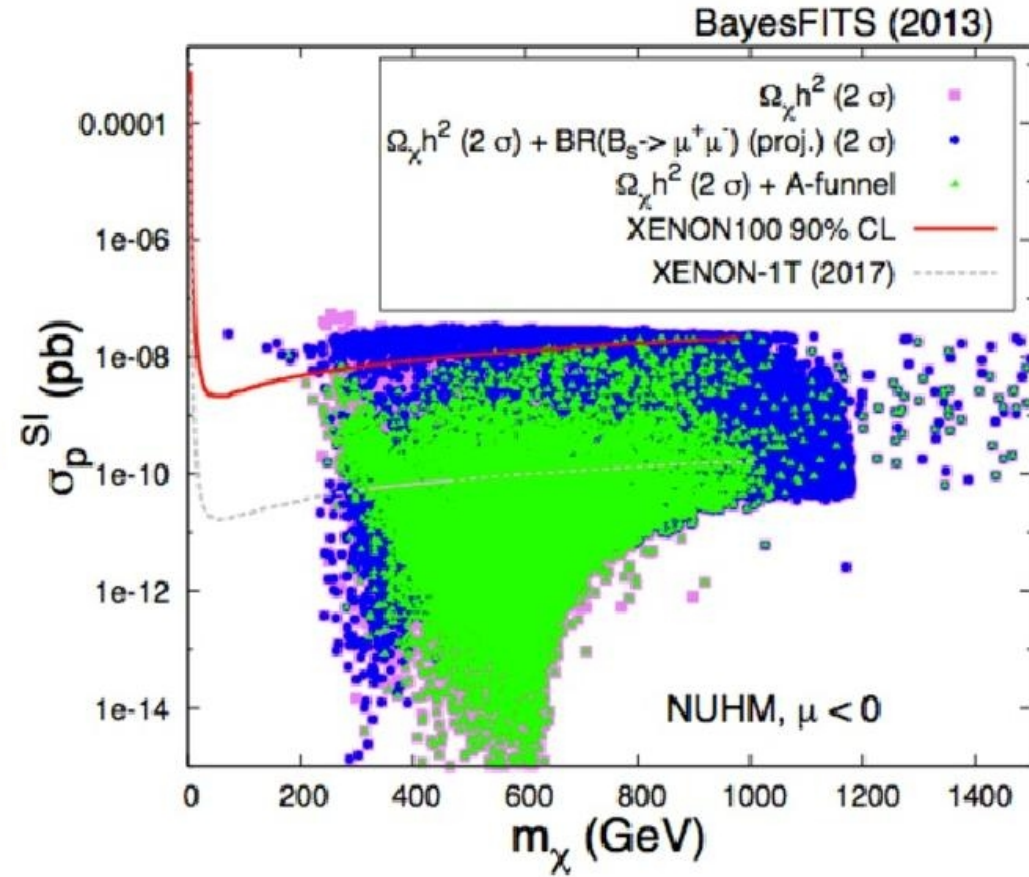
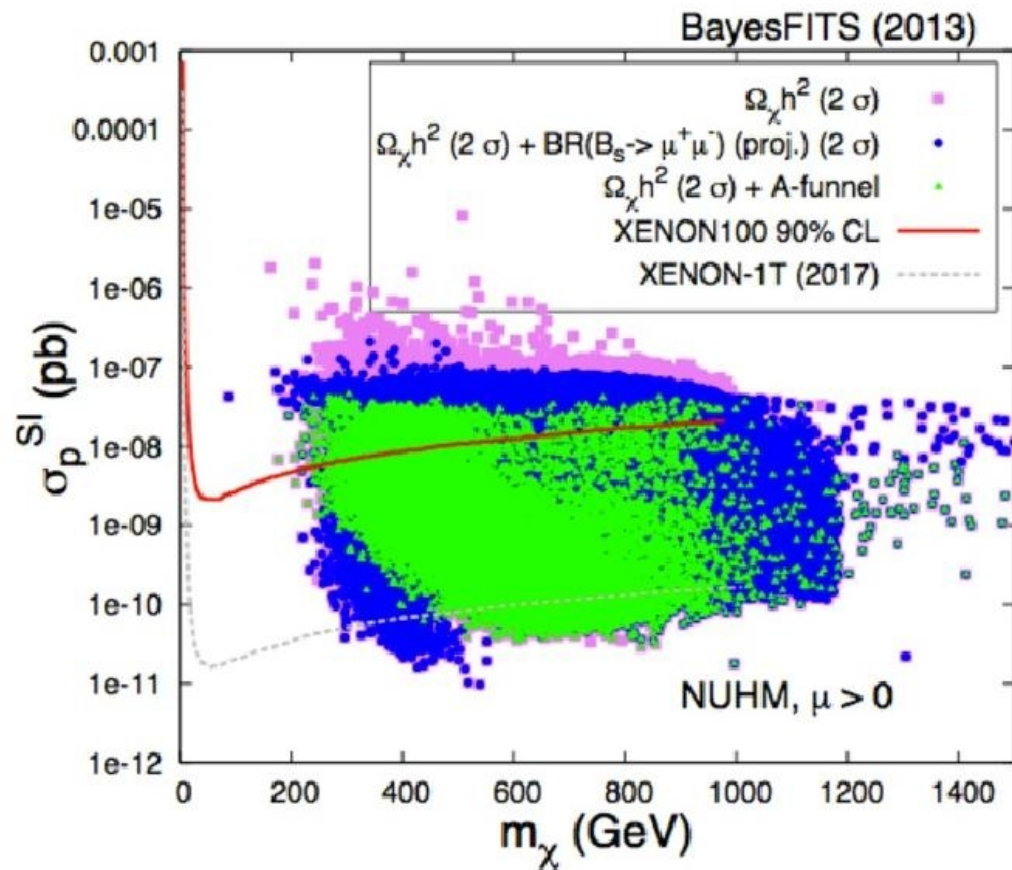

pink square points satisfy : $\Omega_\chi h^2 @ 2\sigma$

blue circle points satisfy : $\Omega_\chi h^2 + BR(B_s \rightarrow \mu^+ \mu^-) @ 2\sigma$

green triangle points satisfy : $\Omega_\chi h^2 @ 2\sigma + |m_A - 2m_\chi| < 100 \text{ GeV}$

the A funnel region will remain prominently allowed even if a future determination of $BR(B_s \rightarrow \mu^+ \mu^-)$ will narrow it down to basically the SM value

Dark Matter : beyond CMSSM \rightarrow pMSSM

example 2 : 'phenomenological MSSM' pMSSM

$\tan \beta$	[5, 50]	M_{L_3}	[70, 500]
M_{A^0}	[100, 1000]	M_{R_3}	[70, 500]
M_1	[10, 70]	A_τ	[-1000, 1000]
M_2	[100, 1000]	M_{L_1}	[100, 500]
μ	[100, 1000]	M_{R_1}	[100, 500]

LEP limits	$m_{\tilde{\chi}_1^\pm} > 100$ GeV $m_{\tilde{\tau}_1} > 84 - 88$ GeV (depending on $m_{\tilde{\chi}_1^0}$)
invisible Z decay	$\Gamma_{Z \rightarrow \tilde{\chi}_1^0 \tilde{\chi}_1^0} < 3$ MeV
μ magnetic moment	$\Delta a_\mu < 4.5 \times 10^{-9}$
flavor constraints	$\text{BR}(b \rightarrow s\gamma) \in [3.03, 4.07] \times 10^{-4}$ $\text{BR}(B_s \rightarrow \mu^+ \mu^-) \in [1.5, 4.3] \times 10^{-9}$
Higgs mass	$m_{h^0} \in [122.5, 128.5]$ GeV
$A^0, H^0 \rightarrow \tau^+ \tau^-$	CMS results for $\mathcal{L} = 17 \text{ fb}^{-1}$, m_h^{max} scenario
Higgs couplings	ATLAS, CMS and Tevatron global fit, see text
relic density	$\Omega h^2 < 0.131$ or $\Omega h^2 \in [0.107, 0.131]$
direct detection	XENON100 upper limit
indirect detection	Fermi-LAT bound on gamma rays from dSphs
$pp \rightarrow \tilde{\chi}_2^0 \tilde{\chi}_1^\pm$ $pp \rightarrow \tilde{\ell}^+ \tilde{\ell}^-$	Simplified Models Spectra approach, see text

Dark Matter : beyond CMSSM \rightarrow pMSSM

example 2 : 'phenomenological MSSM' pMSSM

$\tan \beta$	[5, 50]	M_{L3}	[70, 500]
M_{A^0}	[100, 1000]	M_{R3}	[70, 500]
M_1	[10, 70]	A_τ	[-1000, 1000]
M_2	[100, 1000]	M_{L1}	[100, 500]
μ	[100, 1000]	M_{R1}	[100, 500]

'basics constraints'

LEP limits	$m_{\tilde{\chi}_1^\pm} > 100$ GeV $m_{\tilde{\tau}_1} > 84 - 88$ GeV (depending on $m_{\tilde{\chi}_1^0}$)
invisible Z decay	$\Gamma_{Z \rightarrow \tilde{\chi}_1^0 \tilde{\chi}_1^0} < 3$ MeV
μ magnetic moment	$\Delta a_\mu < 4.5 \times 10^{-9}$
flavor constraints	$\text{BR}(b \rightarrow s\gamma) \in [3.03, 4.07] \times 10^{-4}$ $\text{BR}(B_s \rightarrow \mu^+ \mu^-) \in [1.5, 4.3] \times 10^{-9}$
Higgs mass	$m_{h^0} \in [122.5, 128.5]$ GeV
$A^0, H^0 \rightarrow \tau^+ \tau^-$	CMS results for $\mathcal{L} = 17 \text{ fb}^{-1}$, m_h^{max} scenario
Higgs couplings	ATLAS, CMS and Tevatron global fit, see text
relic density	$\Omega h^2 < 0.131$ or $\Omega h^2 \in [0.107, 0.131]$
direct detection	XENON100 upper limit
indirect detection	Fermi-LAT bound on gamma rays from dSphs
$pp \rightarrow \tilde{\chi}_2^0 \tilde{\chi}_1^\pm$ $pp \rightarrow \tilde{\ell}^+ \tilde{\ell}^-$	Simplified Models Spectra approach, see text

Dark Matter : beyond CMSSM \rightarrow pMSSM

compatible with Higgs signal strength
as derived in arXiv 1306.2941

fulfill 'basics constraints'
and $A, H \rightarrow \tau\tau$ from CMS
(cyan)

$0.107 < \Omega h^2 < 0.131$
(orange)

pass LHC limits on neutralinos
charginos and sleptons
red and orange

grey points: pass all constraints including DM
but excluded by LHC

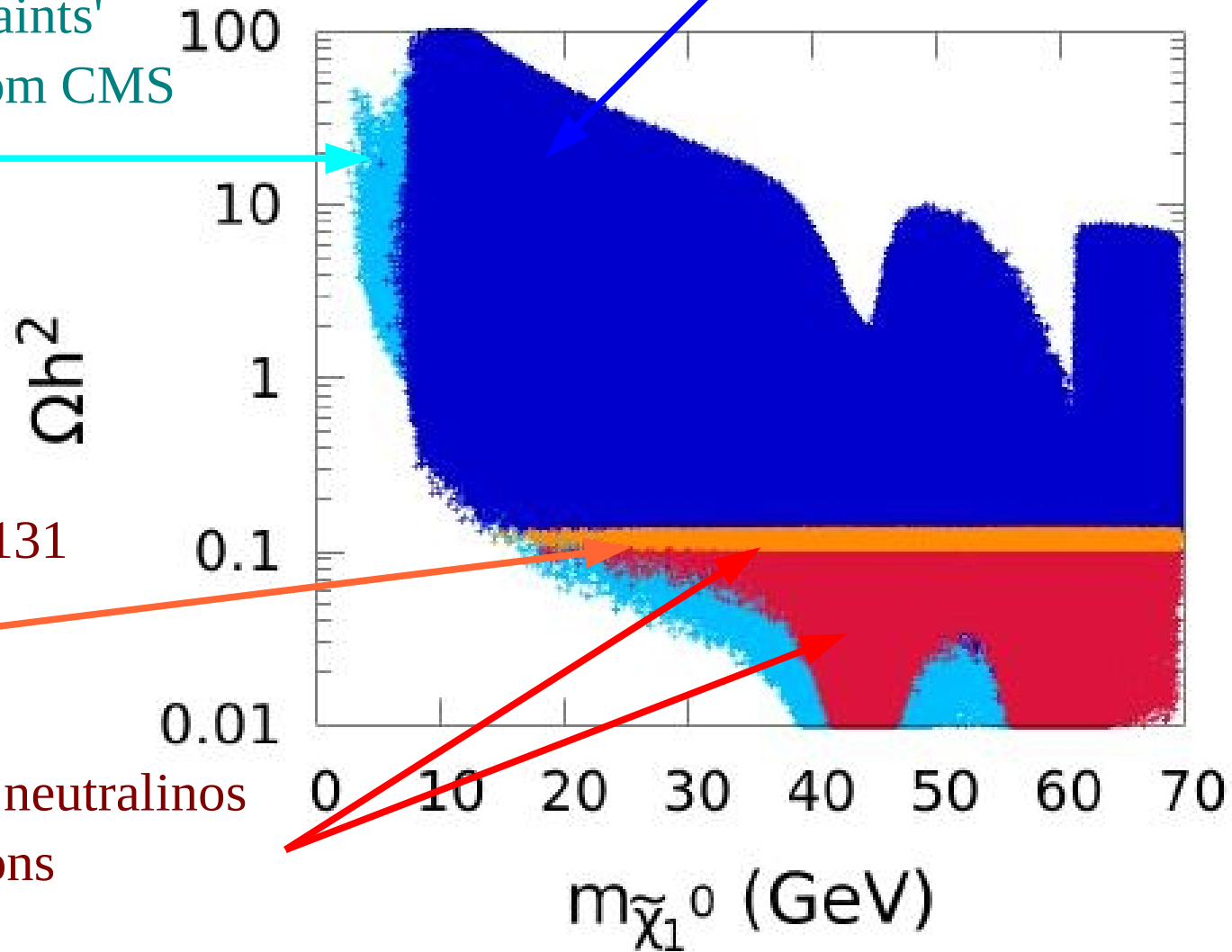

Dark Matter : beyond CMSSM \rightarrow pMSSM

compatible with Higgs signal strength
as derived in arXiv 1306.2941

fulfill 'basics constraints'
and $A, H \rightarrow \tau\tau$ from CMS
(cyan)

$0.107 < \Omega h^2 < 0.131$
(orange)

pass LHC limits on neutralinos
charginos and sleptons
red and orange

grey points: pass all constraints including DM
but excluded by LHC

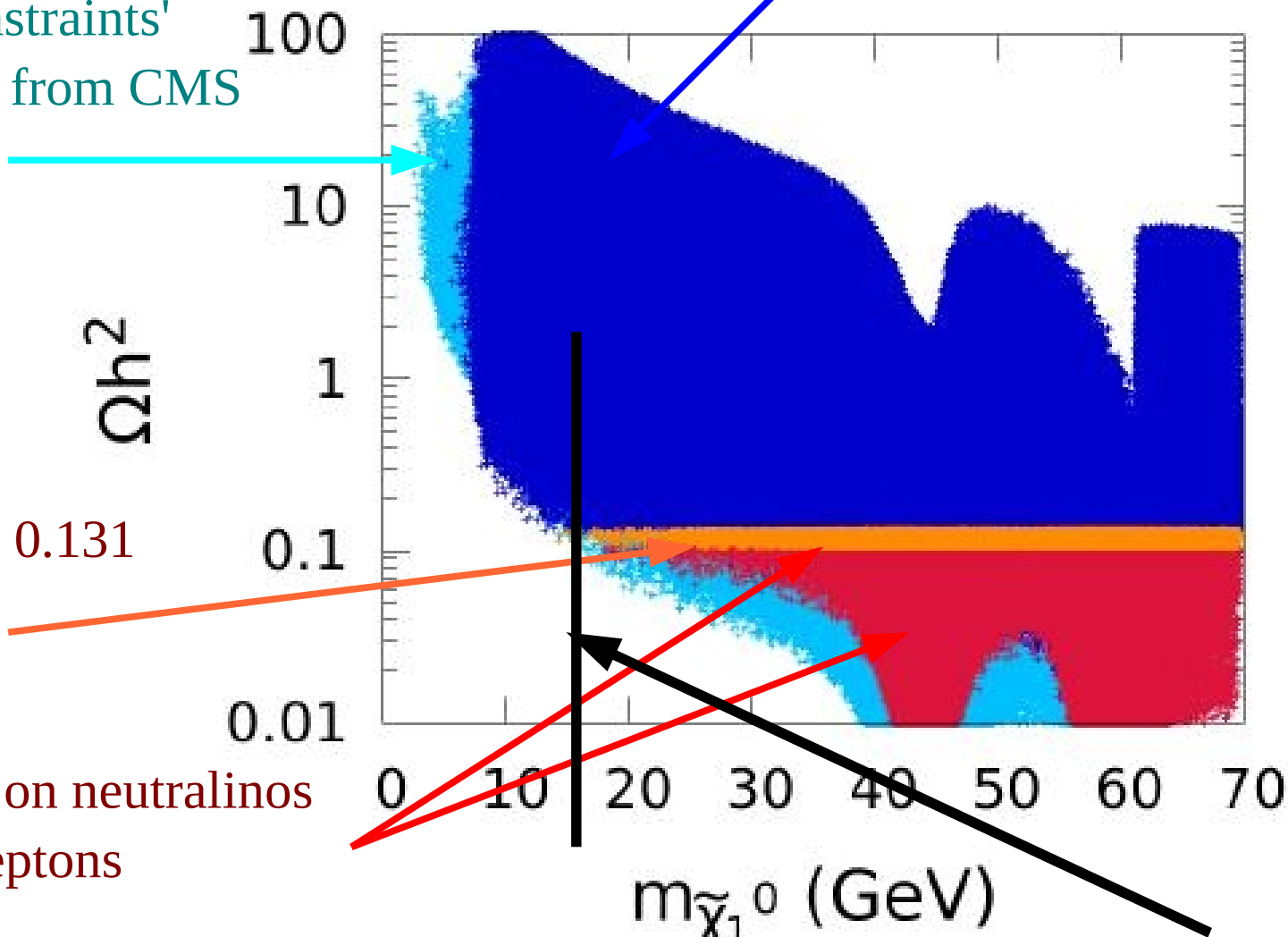

$m_{\tilde{\chi}_1^0} > 15$ GeV
from Ωh^2 constraints

Dark Matter : beyond CMSSM \rightarrow pMSSM

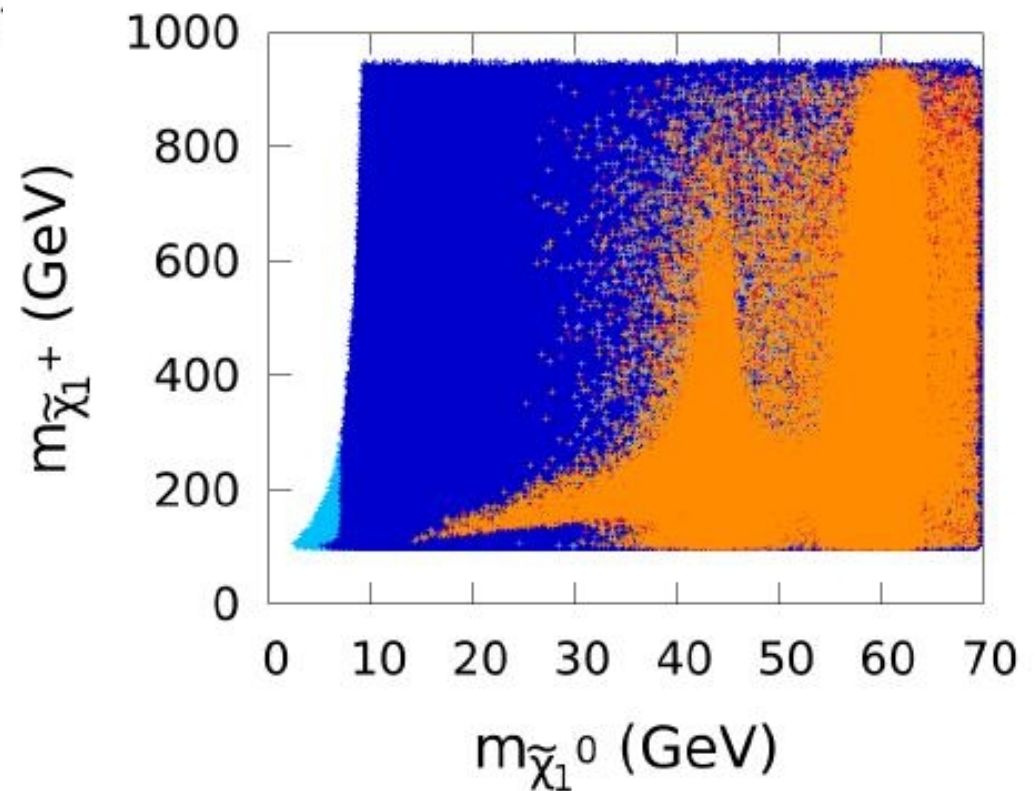
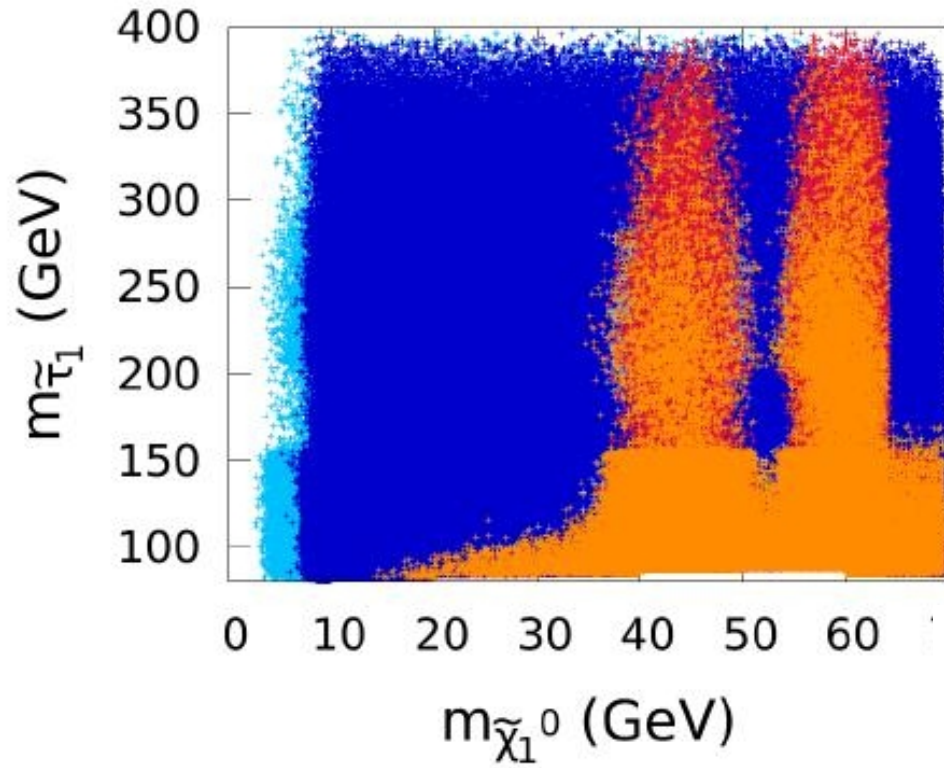

Dark Matter : beyond MSSM → NMSSM

NMSSM superpotential can be written as :

$$W_{NMSSM} = \boxed{-L \cdot H_d \lambda_e E - Q \cdot H_d \lambda_d D + Q \cdot H_u \lambda_u U} + \boxed{\lambda S H_d \cdot H_u + \frac{\kappa}{3} S^3}$$

MSSM superpotential (without the μ term) additional terms

3 CP-even neutral Higgs boson H_i , $i=1,2,3$ which mix in general

2 CP-odd neutral Higgs boson A_1, A_2

5 neutralinos : mixture of bino, neutral wino neutral higgsinos and singlino

$$\tilde{\chi}_i^0 = N_{i1} \tilde{B} + N_{i2} \tilde{W}^3 + N_{i3} \tilde{H}_d^0 + N_{i4} \tilde{H}_u^0 + N_{i5} \tilde{S}$$

$$M_{\tilde{\chi}} = \begin{pmatrix} M_1 & 0 & -\frac{g_1 v_d}{\sqrt{2}} & \frac{g_1 v_u}{\sqrt{2}} & 0 \\ M_2 & \frac{g_2 v_d}{\sqrt{2}} & -\frac{g_2 v_d}{\sqrt{2}} & 0 & 0 \\ 0 & 0 & -\lambda \langle S \rangle & -\lambda v_u & 0 \\ 0 & 0 & 0 & -\lambda v_d & 0 \\ 0 & 0 & 0 & 0 & 2\kappa \langle S \rangle \end{pmatrix}$$

in the basis $(-i\tilde{B}, -i\tilde{W}^3, \tilde{H}_d^0, \tilde{H}_u^0, \tilde{S})$

Dark Matter : beyond MSSM \rightarrow NMSSM

$$\sigma^{SI} \sim N_{11}^2 N_{13}^2 \tan^2 \frac{\beta}{m_H^4}$$

$$\sigma^{SD} \sim (N_{13}^2 - N_{14}^2)^2$$

$$\sigma_{\text{ann}} \sim \frac{1}{(m_{A_1}^2 - 4m_{\tilde{\chi}_1^0}^2)^2}$$

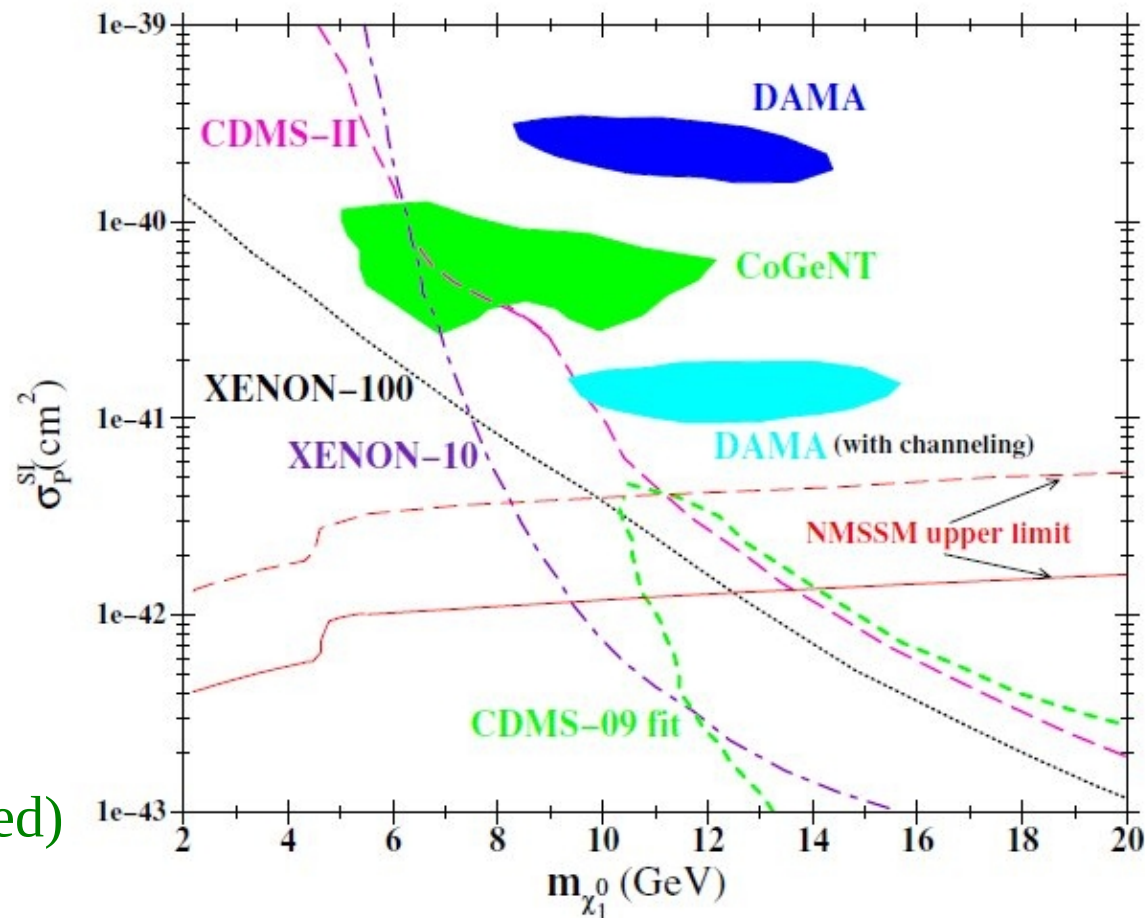

including constraints from (to be updated)

- LEP : $\sigma(e^+ e^- \rightarrow \tilde{\chi}_1^0 \tilde{\chi}_i^0)$ and, $\Delta\Gamma_Z^{\text{inv}}$

- B physics : $b \rightarrow s\gamma$, ΔM_s , ΔM_d , $B_s \rightarrow \mu^+ \mu^-$, $B^+ \rightarrow \tau^+ \nu_\tau$

- WMAP : Ωh^2

Dark Matter : beyond MSSM \rightarrow NMSSM

$$\sigma^{SI} \sim N_{11}^2 N_{13}^2 \tan^2 \frac{\beta}{m_H^4}$$

$$\sigma^{SD} \sim \left(N_{13}^2 - N_{14}^2 \right)^2$$

$$\sigma_{\text{ann}} \sim \frac{1}{\left(m_{A_1}^2 - 4m_{\tilde{\chi}_1^0}^2 \right)^2}$$

- 'my' XENON 100 'points' at 6 and 10 GeV mass

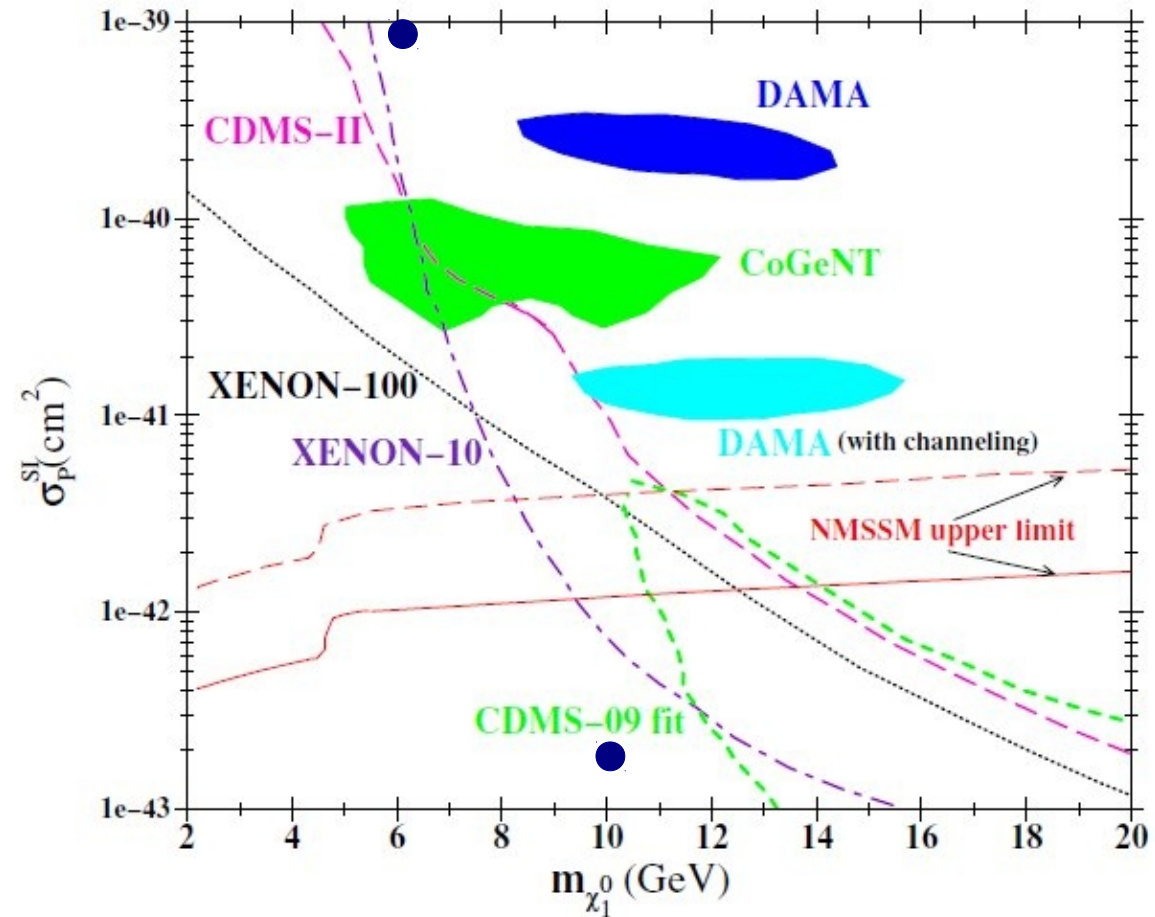

Dark Matter : Dirac gauginos (beyond N=1 ?)

reminder :

before breaking of SUSY, SUSY extension of SM have a so called continuous R-symmetry

$$V(x, \theta, \bar{\theta}) \rightarrow V(x, \theta e^{-i\alpha}, \bar{\theta} e^{i\alpha}) \quad \text{for gauge superfields}$$

$$S(x, \theta) \rightarrow e^{i\alpha} S(x, \theta e^{-i\alpha}) \quad \text{for quark and lepton superfields}$$

$$H_{d,u}(x, \theta) \rightarrow e^{i\alpha} H_{d,u}(x, \theta e^{-i\alpha}) \quad \text{for Higgs superfields}$$

which prevents, for example, gluino and gravitino (Majorana particles) to have mass !

gluino have not been observed \Rightarrow supersymmetry must be broken
(argument already existing at the time of P. Fayet !)

\Rightarrow one must abandon the continuous R-invariance in favor of its discrete version
i.e. R-parity (see for example R. Barbier et al. PRC 420 (2005) 1)

\Rightarrow **get MSSM with massive gauginos including neutralinos (Majorana particles) and conserved R-parity**

M.R. Buckley, D. Hooper, J. Kumar, arXiv:1307.3561

K. Benakli, Fortschr. Phys. 50 (2011) 1079

K. Benakli, M.D. Goodsell, A.K. Maier, NPB 851 (2011) 445

K. Benakli, M.D. Goodsell, NPB 816 (2009) 185

K. Benakli, M.D. Goodsell, NPB 830 (2010) 315

K. Benakli, M.D. Goodsell, NPB 840 (2010) 1

G. Belanger, K. Benakli, M.D. Goodsell, C. Moura, A. Pukhov, JCAP 08 (2009) 027

Dark Matter : Dirac gauginos (beyond N=1 ?)

other equivalent ways to see this \Rightarrow

- R-symmetry broken in MSSM by **Majorana** gaugino masses
- in R-symmetric models gauginos cannot acquire **Majorana** mass terms

however one can still go back to R-symmetric SUSY models by considering **Dirac** gauginos instead of **Majorana** gauginos

\Rightarrow this requires new chiral superfields in adjoint representation of SM gauge groups which combine with the Majorana gauginos to form Dirac states

- one can add an adjoint singlet S for U(1), triplet T for SU(2) and octet O for SU(3)
such additional particle content in the weak-scale spectrum can be motivated in models with N=2 supersymmetry
- the singlet can also give rise to $\mu H_u H_d$ à la NMSSM
- gravitational multiplet (in which gravitino is) must be extended in N=2 representations

Dark Matter : Dirac gauginos (beyond N=1 ?)

in addition the presence of μ and $B\mu$ terms for the Higgs doublet is incompatible with an R-symmetry \Rightarrow

- one can consider the Higgs sector as the main source of R-symmetry breaking
(Benakli et al)

- one can generate masses for Higgsinos if the Higgs sector is enlarged to include multiplet R_u, R_d allowing for terms of the form: $\mu_u H_u R_u + \mu_d H_d R_d$
(Hooper et al)

R_u, R_d do not participate to EWSB but allow for Higgsinos masses without breaking R-symmetry within N=2 supersymmetry H_u, R_u and H_d, R_d constitute a complete hypermultiplet

depending on the approach one can get different kind of Dirac neutralino mass matrix after EWSB

for example (Hooper et al) :

$$\left(\tilde{B}', \tilde{W}', \tilde{H}_d, \tilde{H}_u \right) \begin{pmatrix} M_1 & 0 & -M_Z \cos \beta \sin \theta_w & M_Z \sin \beta \sin \theta_w \\ 0 & M_2 & M_Z \cos \beta \cos \theta_w & -M_Z \sin \beta \cos \theta_w \\ -M_Z \cos \beta \sin \theta_w & M_Z \cos \beta \cos \theta_w & -\mu_d & 0 \\ M_Z \sin \beta \sin \theta_w & -M_Z \sin \beta \cos \theta_w & 0 & -\mu_u \end{pmatrix} \begin{pmatrix} \tilde{B} \\ \tilde{W} \\ \tilde{R}_d \\ \tilde{R}_u \end{pmatrix}$$

Dark Matter : Dirac gauginos (beyond N=1 ?)

- or the LSP can be a linear combination of 6 states (Benakli et al.)

a possible neutralino mass matrix could be :

$$\begin{pmatrix}
 M'_1 & M_{1D} & 0 & 0 & \frac{\sqrt{2}\lambda_S}{g'} M_Z \sin \beta \sin \theta_w & \frac{\sqrt{2}\lambda_S}{g'} M_Z \cos \beta \sin \theta_w \\
 M_{1D} & M_1 & 0 & 0 & -M_Z \cos \beta \sin \theta_w & M_Z \sin \beta \sin \theta_w \\
 0 & 0 & M'_2 & M_{2D} & -\frac{\sqrt{2}\lambda_T}{g} M_Z \sin \beta \cos \theta_w & -\frac{\sqrt{2}\lambda_T}{g} M_Z \cos \beta \cos \theta_w \\
 0 & 0 & M_{2D} & M_2 & M_Z \cos \beta \cos \theta_w & -M_Z \sin \beta \cos \theta_w \\
 \frac{\sqrt{2}\lambda_S}{g'} M_Z \sin \beta \sin \theta_w & -M_Z \cos \beta \sin \theta_w & -\frac{\sqrt{2}\lambda_T}{g} M_Z \sin \beta \cos \theta_w & M_Z \cos \beta \cos \theta_w & 0 & -\mu \\
 \frac{\sqrt{2}\lambda_S}{g'} M_Z \cos \beta \sin \theta_w & -M_Z \sin \beta \sin \theta_w & -\frac{\sqrt{2}\lambda_T}{g} M_Z \cos \beta \cos \theta_w & -M_Z \sin \beta \cos \theta_w & -\mu & 0
 \end{pmatrix}$$

in the $(\tilde{B}', \tilde{B}, \tilde{W}'^0, \tilde{W}^0, \tilde{H}_d^0, \tilde{H}_u^0)$ basis

and with 6 additional parameters in addition to MSSM parameters :

$$M'_1, M'_2, M_{1D}, M_{2D}, \lambda_S, \lambda_T$$

Dark Matter : Dirac gauginos (beyond N=1 ?)

- bino, wino and Dirac-Gaugino-adjoints majorana masses :

$$-\frac{1}{2} \left(M_2 \tilde{W}^o \tilde{W}^o + M_1 \tilde{B} \tilde{B} + M'_2 \tilde{W}'^o \tilde{W}'^o + M'_1 \tilde{B}' \tilde{B}' \right)$$

- bino, wino and Dirac masses :

$$-M_{2D} \tilde{W}^\alpha \tilde{W}'^\alpha - M_{1D} \tilde{B} \tilde{B}'$$

- gauge interactions between gauginos, higgsinos, Higgses :

$$-\frac{g'}{\sqrt{2}} \left(H_u^* \sigma^i \tilde{H}_u \tilde{B} - H_d^* \sigma^i \tilde{H}_d \tilde{B} \right) - \frac{g}{\sqrt{2}} \left(H_u^* \sigma^i \tilde{H}_u \tilde{W}^i - H_d^* \sigma^i \tilde{H}_d \tilde{W}^i \right)$$

leading to : $-M_Z \left[\sin \theta_w \left(\sin \beta \tilde{H}_u^o \tilde{B} - \cos \beta \tilde{H}_d^o \tilde{B} \right) + \cos \theta_w \left(\cos \beta \tilde{H}_d^o \tilde{W}^o - \sin \beta \tilde{H}_u^o \tilde{W}^o \right) \right]$

- coupling (from superpotential) between Dirac-Gauginos adjoint, Higgs and Higgsinos :

$$-\lambda_S \left(H_d \tilde{H}_u \tilde{B}' - H_u \tilde{H}_d \tilde{B}' \right) - \lambda_T \left[H_u \left(\sigma^i \tilde{H}_d \right) \tilde{W}'^i - H_d \left(\sigma^i \tilde{H}_u \right) \tilde{W}'^i \right]$$

giving : $-M_Z \left[\frac{\sqrt{2} \lambda_S \sin \theta_w}{g'} \left(\sin \beta \tilde{H}_d^o \tilde{B}' + \cos \beta \tilde{H}_u^o \tilde{B}' \right) - \frac{\sqrt{2} \lambda_T \cos \theta_w}{g} \left(\cos \beta \tilde{H}_u^o \tilde{W}'^o + \sin \beta \tilde{H}_d^o \tilde{W}'^o \right) \right]$

- μ term contributing to the higgsinos masses :

$$\mu \tilde{H}_u^o \tilde{H}_d^o$$

Dark Matter : Dirac gauginos (beyond N=1 ?)

contours of $\Omega h^2 = 0.11$ (mixed bino/wino/higgsinos LSP) scenario in (M_{1D}, M_{2D})

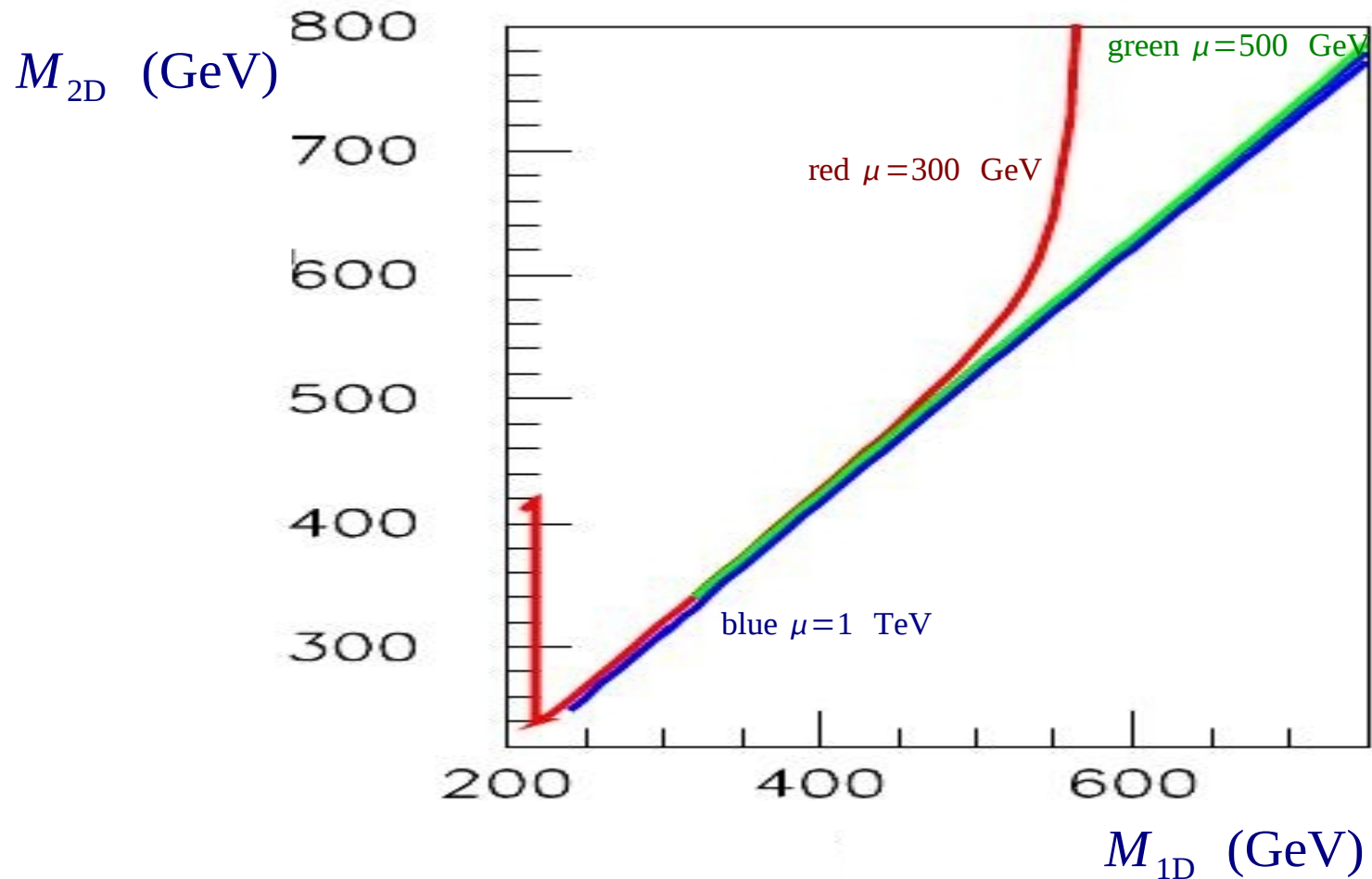

Dark Matter : Dirac gauginos (beyond N=1 ?)

elastic scattering Xsections
mixed bino/wino/higgsino scenario

prediction for Dirac gaugino models for elastic scattering cross sections are usually suppressed when compared to an equivalent MSSM scenario because :

- LSP has lower Higgsino fraction
- relic abundance relies more on coannihilation in DG
- further suppression due to interference between squark and Higgs exchange (dips for $\mu=300, 500$ GeV)

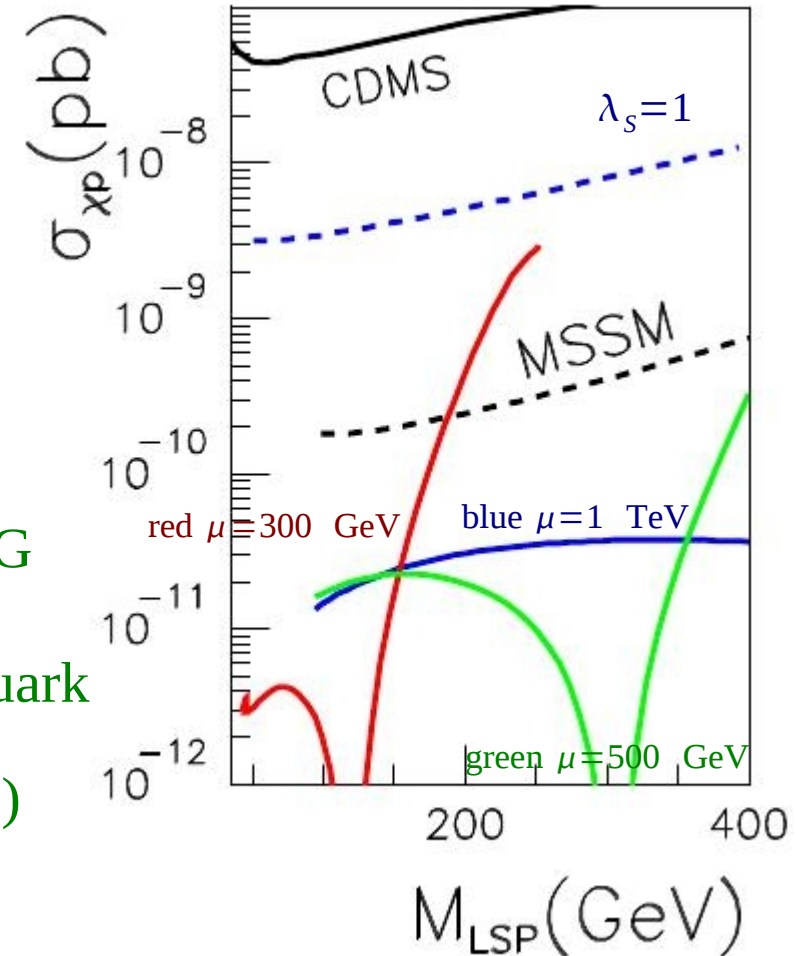

a large increase is expected when LSP has significant Higgsinos fraction
this occurs when $M_{LSP} \sim \mu$ or when $\lambda_S \neq g' / \sqrt{2}$

Where is dark matter ?

- the WIMP miracle (reminder)

 - back to MSSM

 - relic density

 - interaction with matter

- some recent non-accelerator experimental results (summer 13')

- some global fits

 - CMSSM (frequentist and Bayesian)

 - beyond CMSSM and MSSM

- **invisible Higgs**

- 2 examples from extra dimensions

- asymmetric DM

- effective field theory approaches (and limitations)

- possible searches at lepton colliders

Invisible Higgs boson decay

bound on invisible Higgs boson decay width constrains the DM elastic scattering cross section on nucleons for DM candidates with mass below $M_H/2$

from global fits

$$BR_{\text{inv}} < 0.24 \quad (\text{solid line})$$



$$BR_{\text{inv}} < 0.34 \quad (\text{dot-dashed})$$

allowing for non standard value of $h \rightarrow \gamma\gamma$ and gg

XENON 1T down to $\sim 10^{-12}$ pb
(for DM masses $\geq 10 - 20$ GeV)

from G. Servant Talk EPS HEP 2013

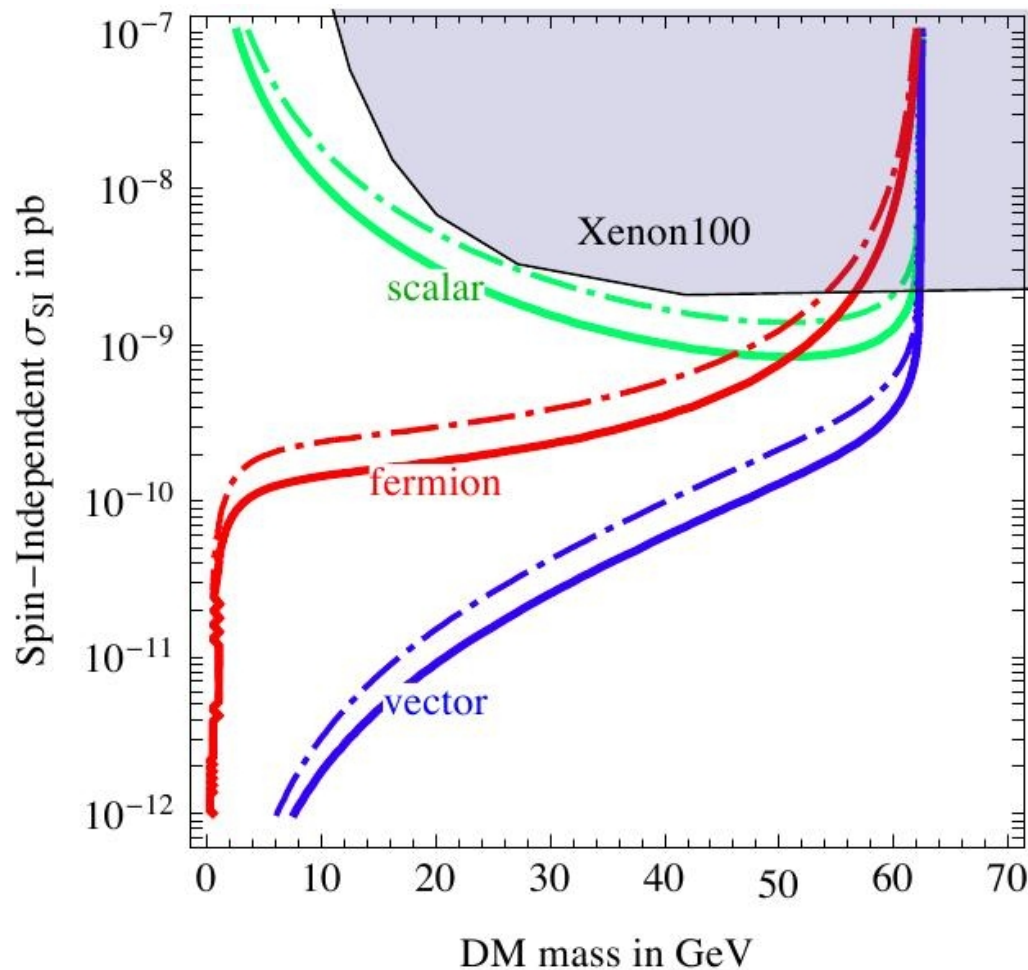

Invisible Higgs boson decay

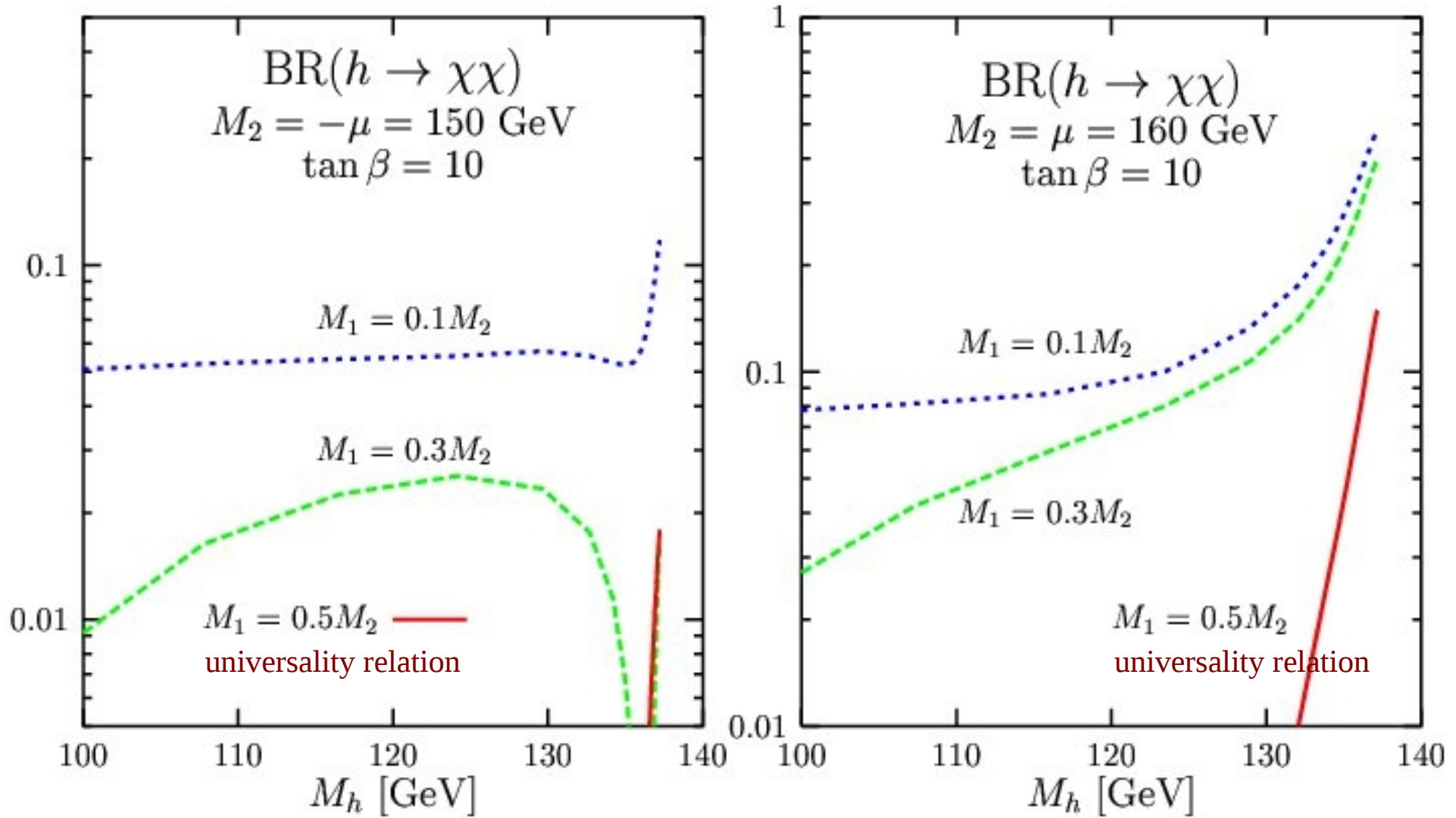

when kinematically allowed \rightarrow sizable $BR(h \rightarrow \tilde{\chi}_1^o \tilde{\chi}_1^o)$
 in particular when universality relation are relaxed

which leads to lighter LSP while the (LEP) bound $m_{\tilde{\chi}_1^\pm} < 104$ GeV is still respected

Invisible Higgs boson decay

BR are smaller for $\mu < 0$ (the inos are less mixed)

BR become smaller for increasing $\tan \beta$ except for $m_h \sim m_h^{max}$

when the universality relation $M_1 \simeq \frac{1}{2} M_2$ is assumed \rightarrow

the phase space allowed by the constraint $m_{\tilde{\chi}_1^\pm} > 104$ GeV is rather narrow
the invisible decay occurs only in a small m_h range near the maximal value
however in the $\mu > 0$ case, the BR can reach the level of 10%

when the universality assumption is relaxed: $M_1 \simeq 0.3 M_2$ and $M_1 \simeq 0.1 M_2 \rightarrow$

the invisible decay $h \rightarrow \tilde{\chi}_1^0 \tilde{\chi}_1^0$ occurs in a much larger portion of the parameter space
despite that in this case $\tilde{\chi}_1^0$ is bino-like and its coupling to h is not very strong
(in particular for $\mu < 0$ it even vanishes for $M_1 \simeq 0.3 M_2$ in a small m_h range near the decoupling limit)

Invisible Higgs boson decay

Prospects on the search for invisible Higgs decays in the ZH channel at the LHC and HL-LHC: A Snowmass White Paper

Hideki Okawa¹, Josh Kunkle², and Elliot Lipeles²

¹Brookhaven National Laboratory, Upton, NY, USA

²University of Pennsylvania, Philadelphia, PA, USA

October 1, 2013

Abstract

We show prospects on a search for invisible decays of a Higgs boson at the Large Hadron Collider (LHC) and High Luminosity LHC (HL-LHC). This search is performed on a Higgs boson produced in association with a Z boson. We expect that the branching ratio of 17-22% (6-14%) could be excluded at 95% confidence level with 300 fb^{-1} (3000 fb^{-1}) of data at $\sqrt{s} = 14 \text{ TeV}$. The range indicates different assumptions on the control of systematic uncertainties. Interpretations with Higgs-portal dark matter models are also considered.

expect BR of 17-22 % (6-14 %) could be excluded at 95% CL at LHC14
at 300 fb^{-1} (3000 fb^{-1})

Where is dark matter ?

- the WIMP miracle (reminder)

 - back to MSSM

 - relic density

 - interaction with matter

- some recent non-accelerator experimental results (summer 13')

- some global fits

 - CMSSM (frequentist and Bayesian)

 - beyond CMSSM and MSSM

- invisible Higgs

- **2 examples from extra dimensions**

- asymmetric DM

- effective field theory approaches (and limitations)

- possible searches at lepton colliders

Minimal Universal Extra Dimensions (mUED)

- all SM fields in a 5D bulk
further extension of TeV^{-1}
- 4D SM particles identified to 0th KK mode
- 1st (and beyond) KK modes are massive
loop corrections involving bulk fields
lead to non degenerate mass spectrum
- EW constraints $\rightarrow M > 300 - 600 \text{ GeV}$
- momentum conservation in bulk
 - \rightarrow KK-parity
 - \rightarrow pheno. similar to SUSY with conserved R-parity

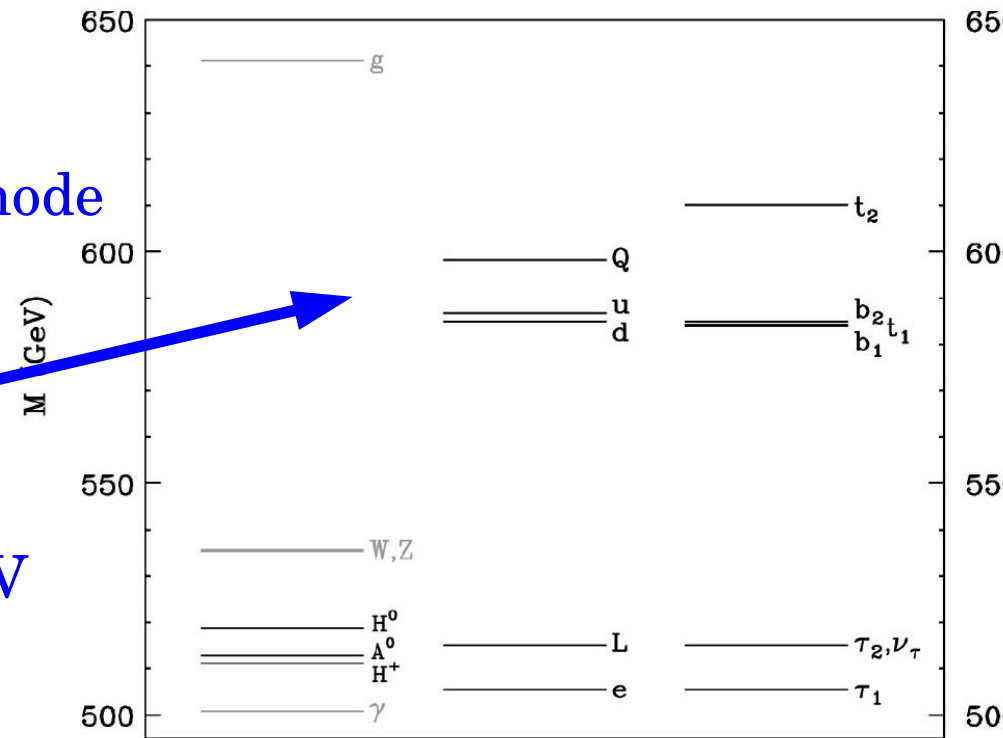

Cheng, Matchev, Schmaltz PRD66, 056006

- **KK states produced in pairs**
- **1 KK + 1 SM in a KK state decay**
possible cascade decays
- **stable LKP (DM candidate)**
source of MET

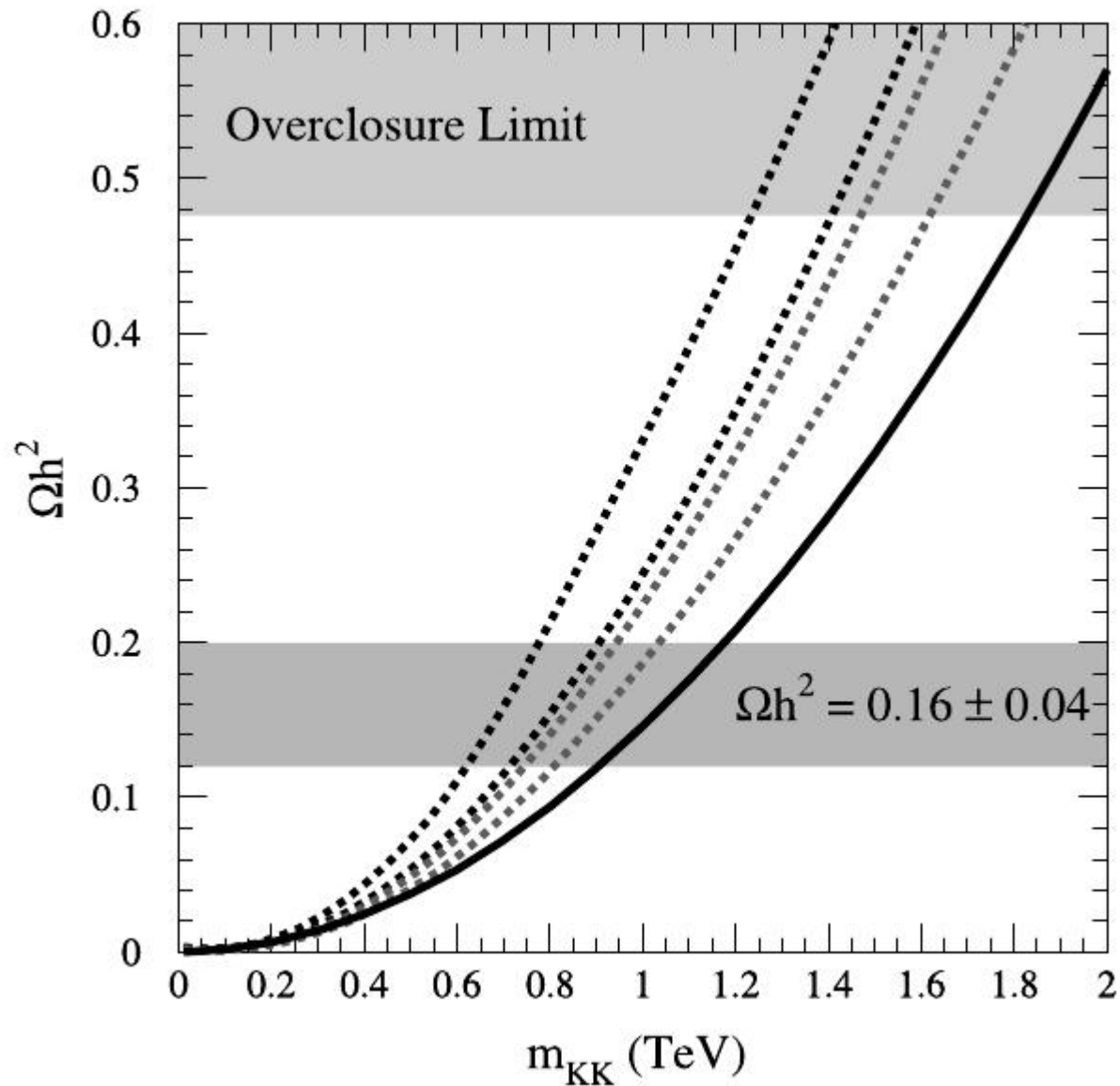

Fig. 3. Prediction for $\Omega_{B^{(1)}} h^2$ as in Fig. 1. The solid line is the case for $B^{(1)}$ alone, and the dashed and dotted lines correspond to the case in which there are one (three) flavors of nearly degenerate $e_R^{(1)}$. For each case, the black curves (upper of each pair) denote the case $\Delta = 0.01$ and the red curves (lower of each pair) $\Delta = 0.05$.

Branon Dark Matter

- in ('flat') extra-dimensions models with low brane tension f (lower than M_D)
fluctuations of the brane along the extra-dimensions are the only relevant low energy modes
- the particles associated to the fluctuations of the brane in the extra dimensions are scalar particles called branons π^α
- branons can be massive (with mass M)
- branons interact by pairs with the SM energy momentum tensor via a mass term and derivative term with f^4 suppressed couplings

$$L_{\text{branon}} = \frac{1}{2} g^{\mu\nu} \partial_\mu \pi^\alpha \partial_\nu \pi^\alpha - \frac{1}{2} M^2 \pi^\alpha \pi^\alpha + \frac{1}{8} f^4 \left(4 \partial_\mu \pi^\alpha \partial_\nu \pi^\alpha - M^2 \pi^\alpha \pi^\alpha g_{\mu\nu} \right) T^{\mu\nu}$$

- branons are stable, weakly interacting and invisible \rightarrow DM candidate
- despite their coupling suppression, branons can be abundantly pair produced in association with SM particles at the LHC (and to some extent also at ILC and CLIC, ...)
- for example branons can be pair produced in association with one γ

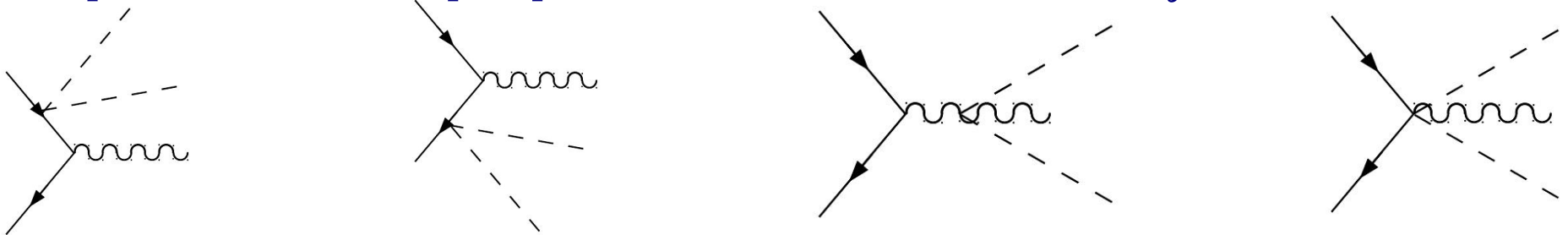

Branon Dark Matter

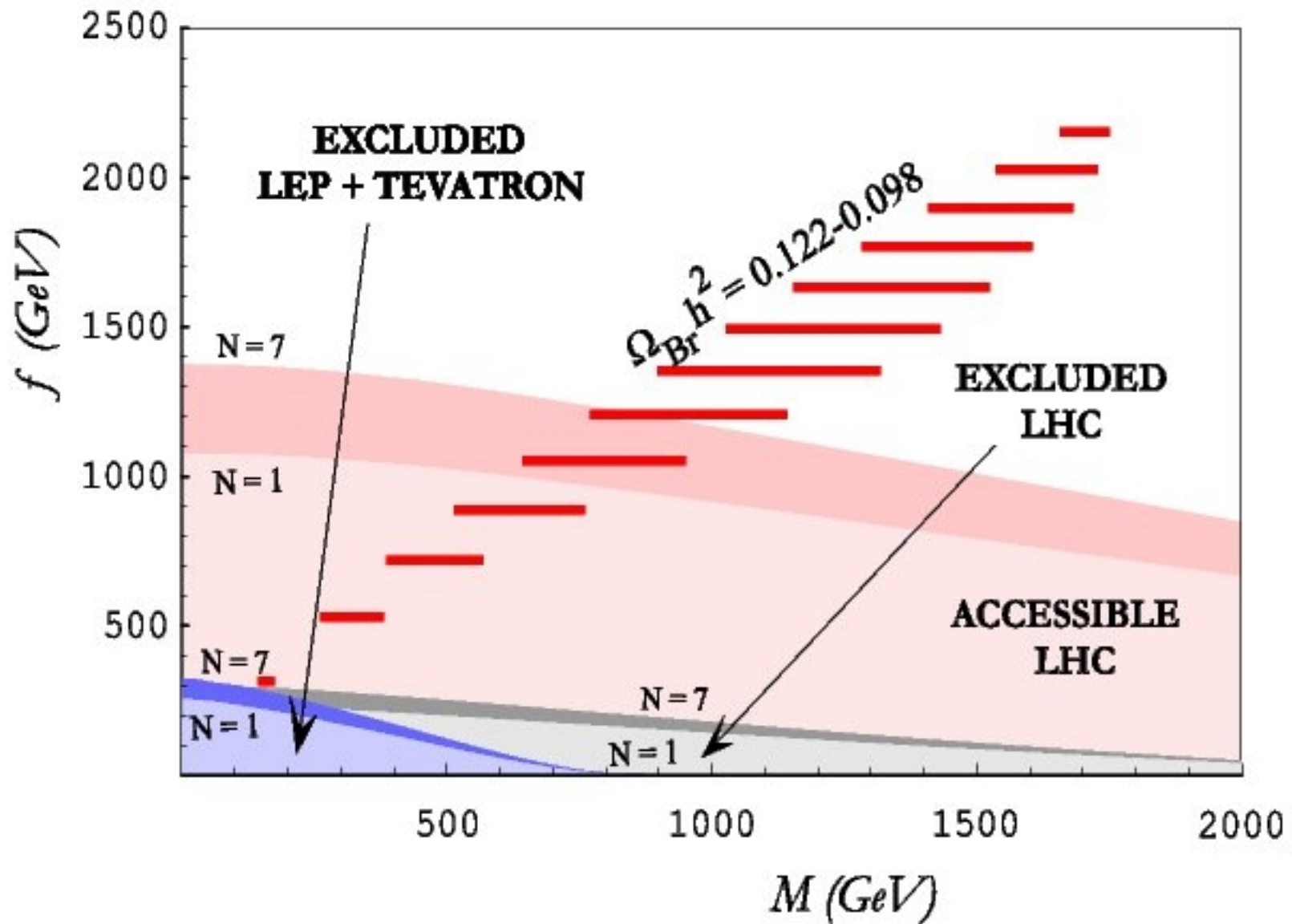

Branon Dark Matter

constraints from Atlas (derived by J.A.R. Cembranos, R.L. Delgado, A Dobado, arXiv:1306.4900)

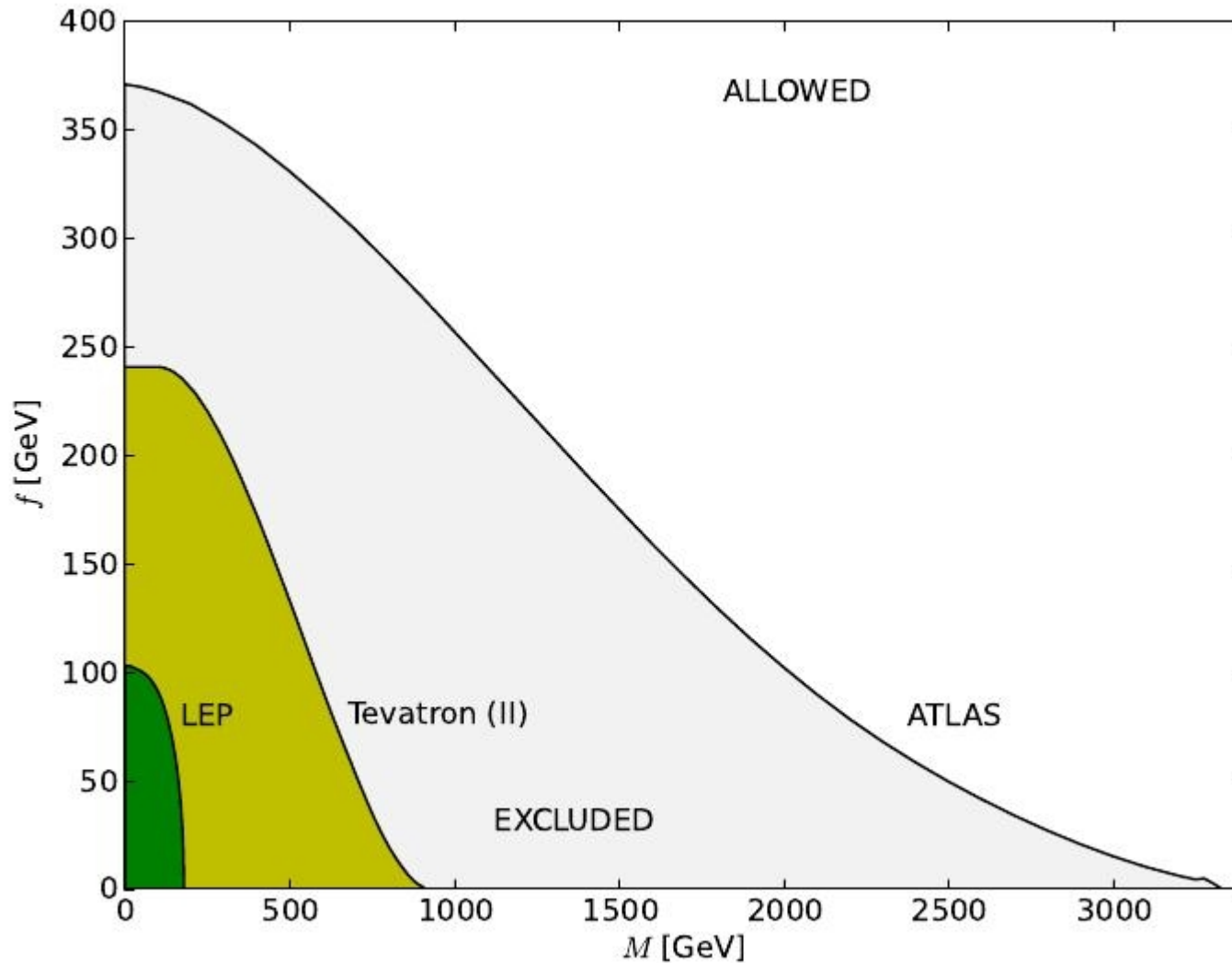

Work in progress for direct constraints from CMS (J. Neveu Thesis)

Where is dark matter ?

- the WIMP miracle (reminder)

 - back to MSSM

 - relic density

 - interaction with matter

- some recent non-accelerator experimental results (summer 13')

- some global fits

 - CMSSM (frequentist and Bayesian)

 - beyond CMSSM and MSSM

- invisible Higgs

- 2 examples from extra dimensions

- **asymmetric DM**

- effective field theory approaches (and limitations)

- possible searches at lepton colliders

Asymmetric Dark Matter (ADM)

i.e. relating baryon and DM abundances

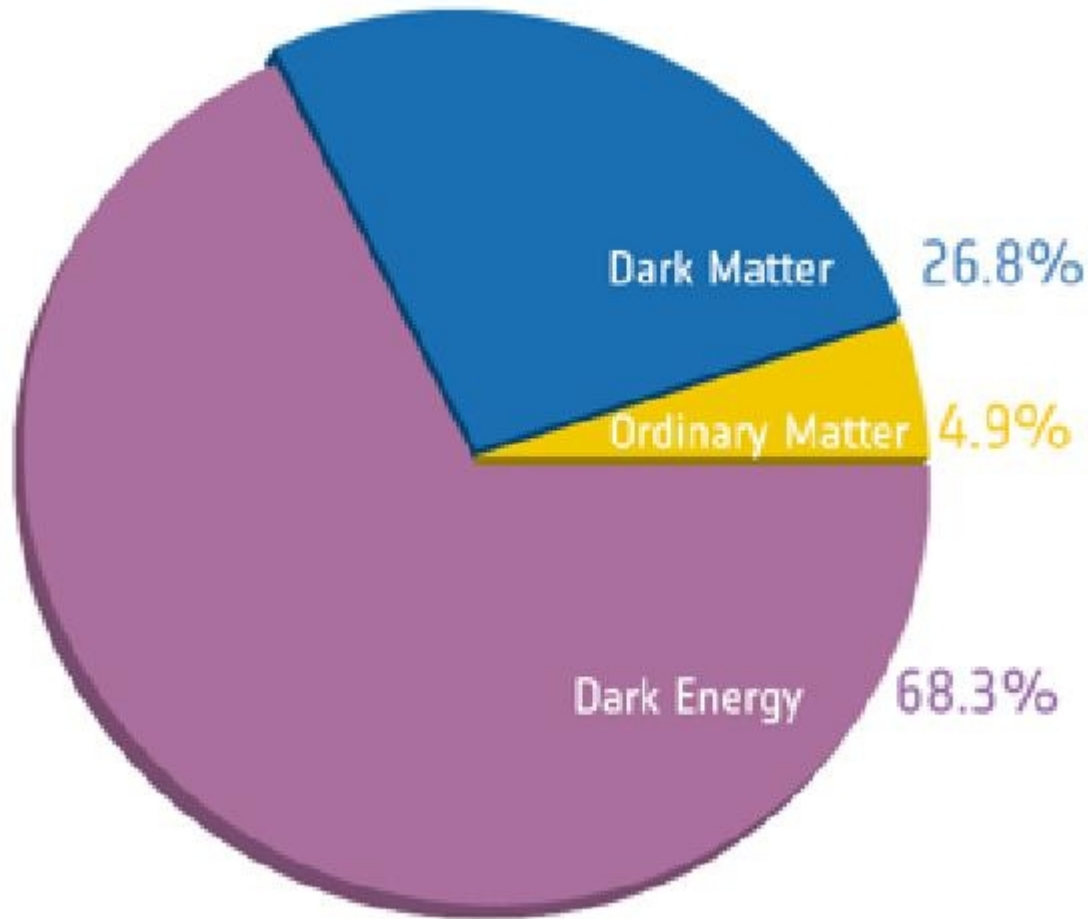

from G. Servant talk EPS 2013 and K. Zurek LP 2013

see Petraki, Volkas arXiv:1305.4939 and Zurek arXiv:1308.0338

$$\Omega_{DM} \sim 5 \Omega_b$$

common dynamics ?

several possibilities :

- asymmetries in baryons and DM generated simultaneously
- pre-existing asymmetry in one transferred to the other

$$n_{DM} \sim n_b$$

$$m_{DM} \sim 5 m_{proton}$$

precise DM mass calculable in a given model

Asymmetric Dark Matter

1) an asymmetry is created in the visible and/or dark sectors

the asymmetry may be created via standard baryo- or lepto-genesis
then communicated to the DM sector

it may be generated in the DM sector and then transferred to the baryons and leptons
in the visible sector

or a baryon and DM asymmetry may be generated simultaneously

2) the process which communicates the asymmetry between sectors decouples
separately freezing the asymmetry in the visible and dark sectors

3) if the dark sector was thermalized in the process of asymmetry generation
the symmetric abundance must efficiently annihilate away

by analogy with the SM sector, the most efficient way is via annihilation to force carriers

for example, $e^+ e^-$ annihilates to photons until only the component fixed by the baryon
asymmetry remains

in the presence of light dark forces a similar process occurs for DM
though other mechanisms (such as higher dimension operators) may also be at work

Asymmetric Dark Matter

transfer mechanisms fall, in general terms, into two categories

- electroweak sphalerons
- higher dimensions and renormalizable interactions

generation mechanisms also fall in general into two categories

- simultaneous generation of baryon and DM asymmetries
sometimes called **cogenesis** electroweak sphalerons

cogenesis may occur via modifications to existing lepto- or baryo-genesis scenarios that incorporate concurrent DM asymmetry generation such as:

- out-of-equilibrium decay
- Affleck-Dine mechanism
- electroweak baryogenesis

- asymmetry generation in the DM sector, which is then communicated via one of the two transfer mechanisms (**Darkogenesis**)

asymmetry can be generated in the DM sector by models that mimic some of the successful features of existing baryogenesis scenario such as

- electroweak baryogenesis
- spontaneous baryogenesis

Asymmetric Dark Matter

with an existing asymmetry in both the DM and visible sectors a small asymmetry floats on top of a large thermal abundance

when the DM carries a substantial asymmetry, the usual freeze-out calculation for the DM relic abundance is modified :

annihilations of $X \bar{X}$ remove most of the thermal symmetric component of DM leaving mostly the asymmetric component

this thermal abundance must be efficiently removed through some mechanism and there are predominantly two ways to do this :

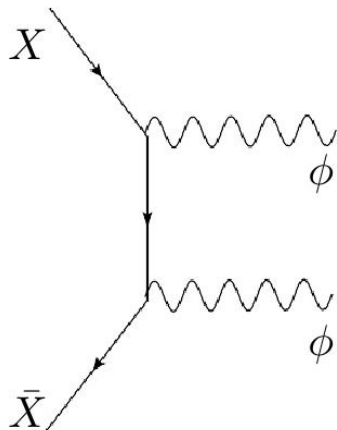

light force mediators Φ (scalar or vector)

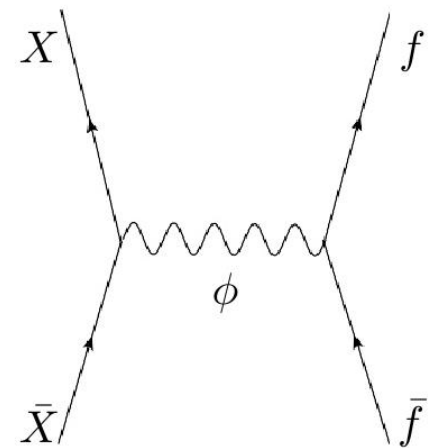

heavier mediators (coupling to SM)

Asymmetric Dark Matter

annihilations only

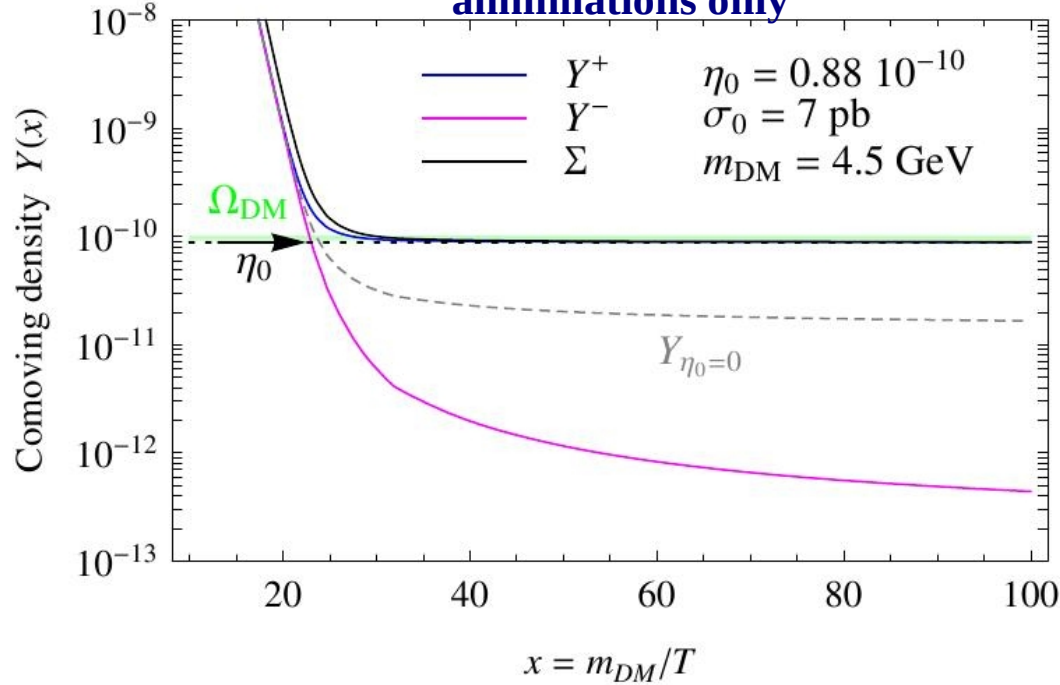

annihilations + oscillations

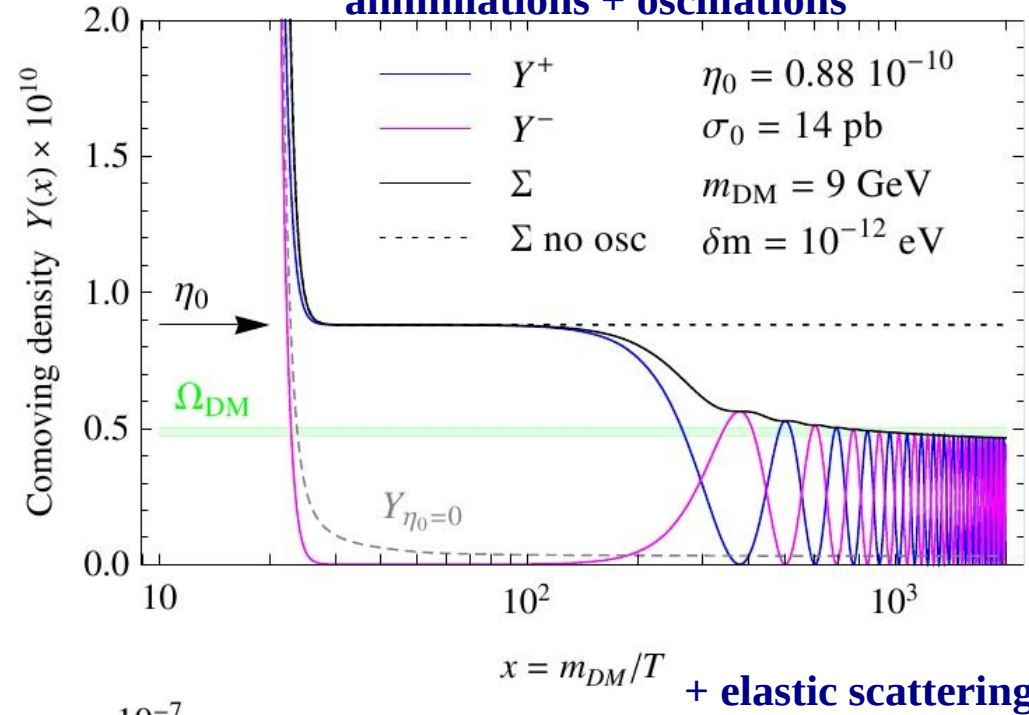

+ elastic scattering

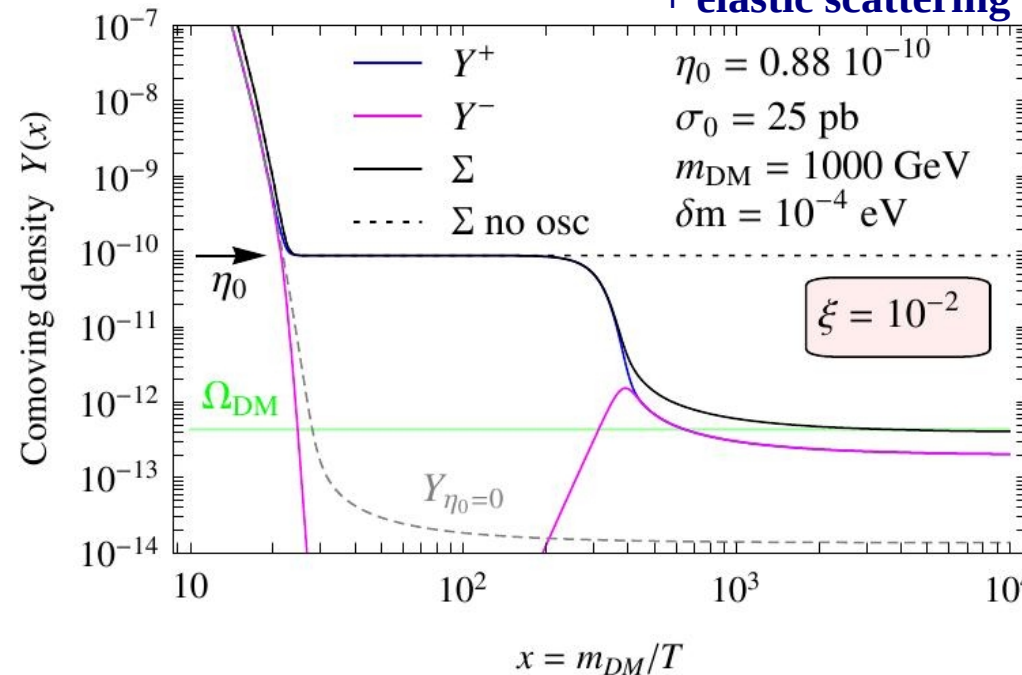

η_0 primordial asymmetry

Y^+ / Y^- DM particle/antiparticle

$$\Sigma = Y^+ + Y^-$$

$$\Omega_{DM} \rightarrow \Omega_{DM}(\langle \sigma v \rangle, \eta_0, m_{DM}, \delta m)$$

Asymmetric Dark Matter

many possible models of asymmetric DM with possible rich dark sector

→ DM may also be stable member(s) of some relatively complicated gauge theory constituting a hidden sector

as proton, electron, photon and neutrino are stable 'relic' of the visible matter (VM) of a larger SM particle content

complicated dark sector is not mandatory but 2 things are :

- a conserved (or approximately conserved) dark global quantum number sometimes called D or B_D for dark baryon number (in contrast to B and/or L number)
- an interaction to annihilate away the symmetric part

Asymmetric Dark Matter

interactions that lead to a relation between VM and DM asymmetries are either described by an explicit renormalizable theory or by effective operators of the form (sometimes called transfer operators):

$$O_{(B-L)_V} O_{B_D}$$

where $O_{(B-L)_V}$ is formed from visible sector fields in a combination that carries non zero $(B-L)_V$

while O_{B_D} is a dark sector analog

the interactions must preserve some linear combination of the $(B-L)_V$ and B_D numbers otherwise they would washout both asymmetries

some of these operators can lead to interesting collider signatures if the effective scale is in the TeV regime

Asymmetric Dark Matter

- in some specific models the connection between VM and dark sector is accomplished through multiple copies of Dirac fermions X
- integrating out X , effective operators of the following form can for example be obtained:

$$\frac{1}{\Lambda^3} \overline{(u_R)^c} \overline{(d_R)^c} \Psi_R \Phi$$

where Ψ and Φ are DM fermion and scalar (in a certain scheme)

- one expect that at the LHC the highest sensitivity will be to these operators containing u and d quarks
- one can have the following interactions:

$$\frac{\lambda}{M^2} \bar{X}_L s_R \overline{(u_R)^c} d_R + \zeta \bar{\Psi} \Phi^*$$

where a certain flavor structure has been specified (M is the scale above which a UV complete theory should be specified)

- through real or virtual X exchange these interactions allow for the process

$$q q' \rightarrow \bar{q} \bar{\Psi} \Phi^* \quad \text{giving rise to mono-jet + MET events at LHC}$$

Asymmetric Dark Matter

ADM models can feature a U(1) gauge interaction that couples to both the visible and dark sector

for example a U(1) interaction with conserved $(B-L)_V - B_D$ charge
the gauged U(1) is spontaneously broken resulting in a massive Z' boson that has decay channels to both VM and dark sector particles

experimentally this manifests as a Z' resonance with an invisible width that that cannot be accounted for by standard neutrinos

$$pp \rightarrow ZZ' \rightarrow l^+ l^- + \text{MET}$$

$$pp \rightarrow \gamma Z'$$

$$e^+ e^- \rightarrow ZZ' \rightarrow l^+ l^- + \text{MET}$$

$$e^+ e^- \rightarrow \gamma Z' \quad \text{i.e. monophoton}$$

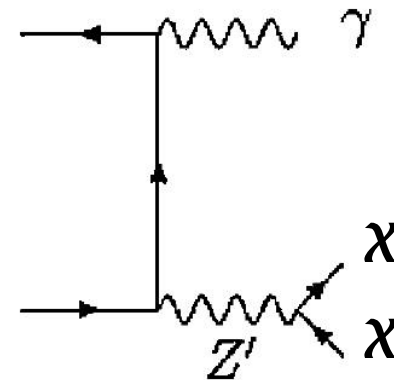
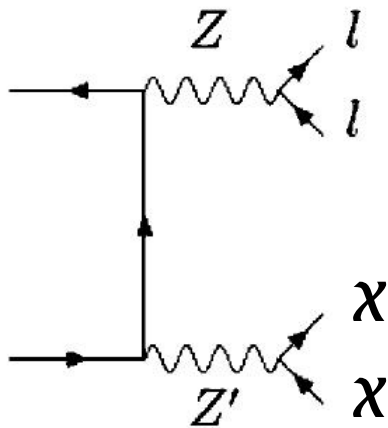

Where is dark matter ?

- the WIMP miracle (reminder)

 - back to MSSM

 - relic density

 - interaction with matter

- some recent non-accelerator experimental results (summer 13')

- some global fits

 - CMSSM (frequentist and Bayesian)

 - beyond CMSSM and MSSM

- invisible Higgs

- 2 examples from extra dimensions

- asymmetric DM

- **effective field theory approaches (and limitations)**

- possible searches at lepton colliders

Dark Matter

assuming WIMP is SM singlet (and a light Majorana particle)

interacting with SM through higher dimensional operators (model independent picture) :

$$L_{\text{int},qq}^{\text{dim } 6} = G_\chi \left[\bar{\chi} \Gamma^\chi \chi \right] \times \left[\bar{q} \Gamma^q q \right]$$

$$L_{\text{int},GG}^{\text{dim } 7} = G_\chi \left[\bar{\chi} \Gamma^\chi \chi \right] \times \left(GG \text{ or } G \tilde{G} \right) \quad \text{where } G \text{ is the gluon field strength and } \tilde{G}^{\mu\nu} = \epsilon^{\mu\nu\rho\sigma} G_{\rho\sigma} / 2$$

assume only one M operator dominating at a time

Name	Type	G_χ	Γ^χ	Γ^q
M1	qq	$m_q/2M_*^3$	1	1
M2	qq	$im_q/2M_*^3$	γ_5	1
M3	qq	$im_q/2M_*^3$	1	γ_5
M4	qq	$m_q/2M_*^3$	γ_5	γ_5
M5	qq	$1/2M_*^2$	$\gamma_5 \gamma_\mu$	γ^μ
M6	qq	$1/2M_*^2$	$\gamma_5 \gamma_\mu$	$\gamma_5 \gamma^\mu$
M7	GG	$\alpha_s/8M_*^3$	1	–
M8	GG	$i\alpha_s/8M_*^3$	γ_5	–
M9	$G\tilde{G}$	$\alpha_s/8M_*^3$	1	–
M10	$G\tilde{G}$	$i\alpha_s/8M_*^3$	γ_5	–

Dark Matter

constraints on M_*

- solid line : 2σ Tevatron constraints
 - dashed line : 5σ LHC reach
 - dashed dotted line : values of M_* reproducing the thermal relic density
 - shaded region : the EFT breaks down
- see also Busoni, De Simone, Morgante Riotto, arXiv:1307.2253 on the validity of EFT for DM @ LHC

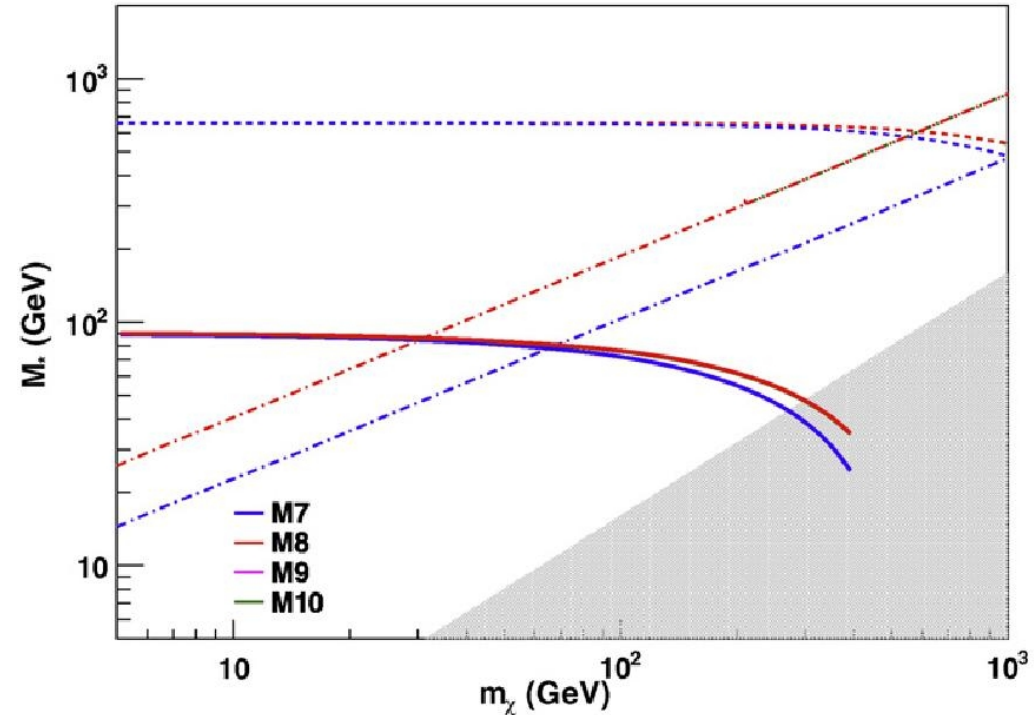
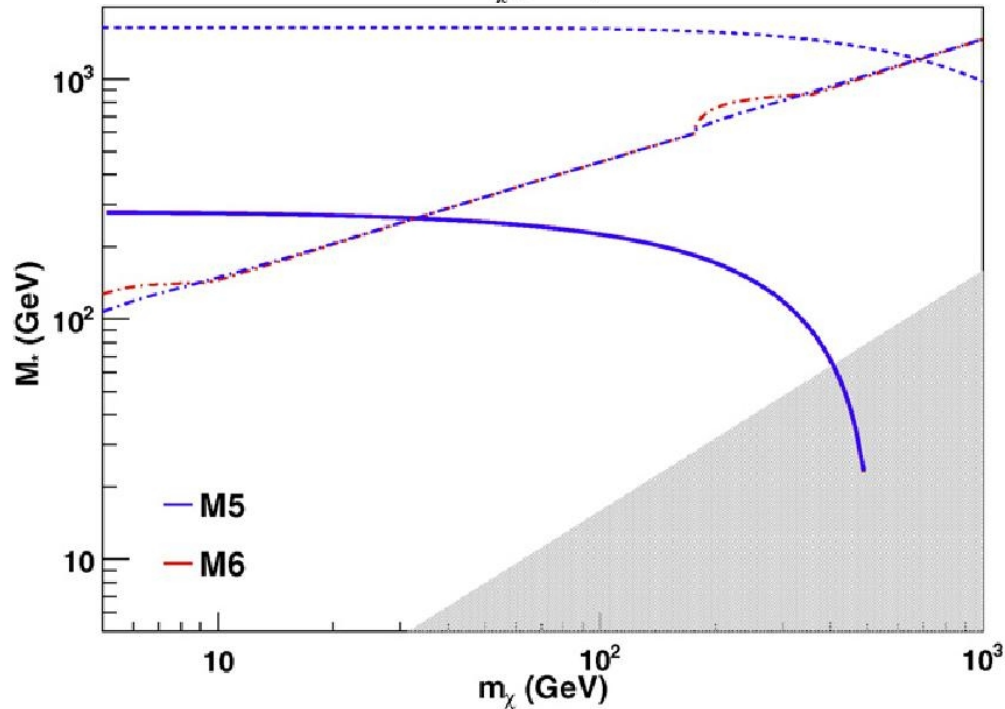
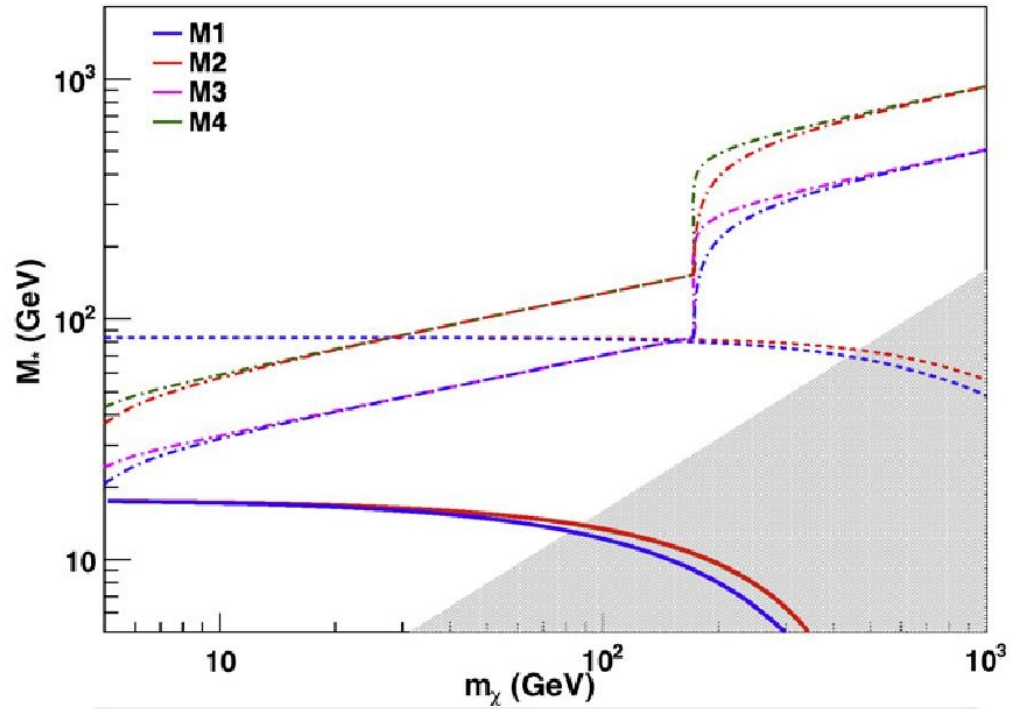

Dark Matter

SI

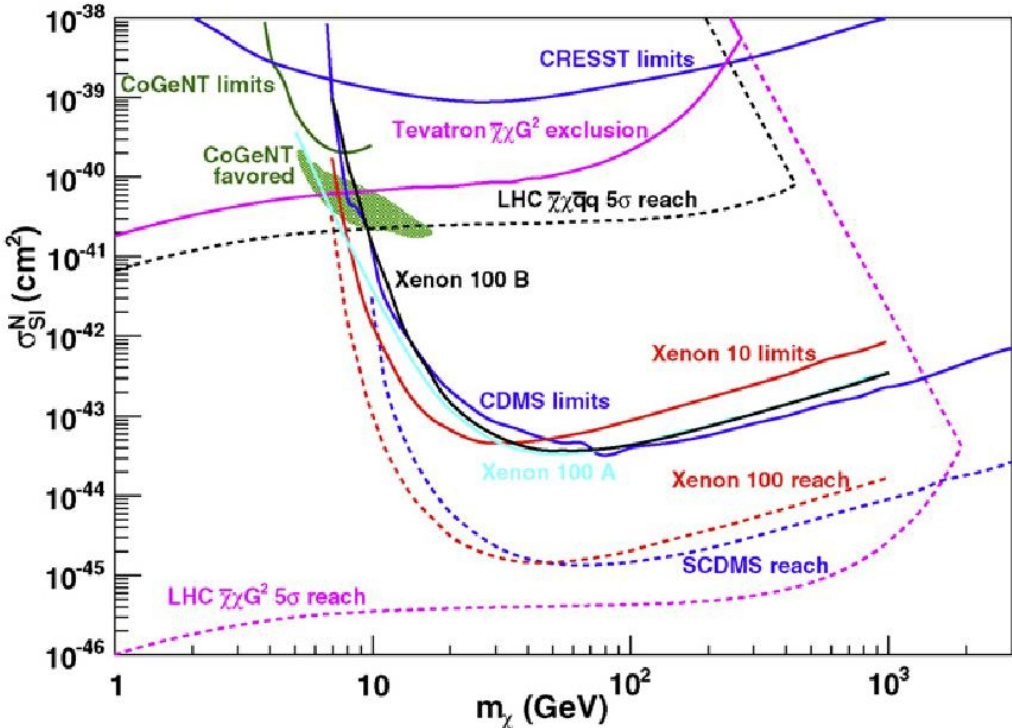

SD

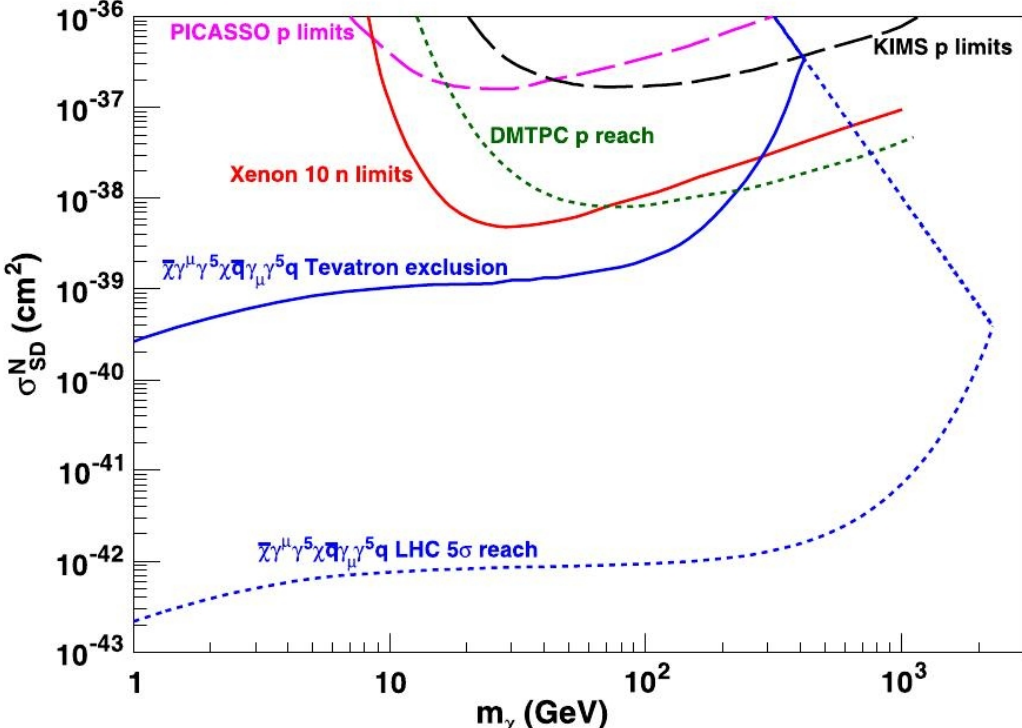

Dark Matter effective field theory approach

operators coupling WIMPS to SM particles

operator names with D, C, R apply to WIMPS that are respectively

- Dirac fermions
- complex scalars
- real scalars

Name	Operator	Coefficient
D1	$\bar{\chi}\chi\bar{q}q$	m_q/M_*^3
D2	$\bar{\chi}\gamma^5\chi\bar{q}q$	im_q/M_*^3
D3	$\bar{\chi}\chi\bar{q}\gamma^5q$	im_q/M_*^3
D4	$\bar{\chi}\gamma^5\chi\bar{q}\gamma^5q$	m_q/M_*^3
D5	$\bar{\chi}\gamma^\mu\chi\bar{q}\gamma_\mu q$	$1/M_*^2$
D6	$\bar{\chi}\gamma^\mu\gamma^5\chi\bar{q}\gamma_\mu q$	$1/M_*^2$
D7	$\bar{\chi}\gamma^\mu\chi\bar{q}\gamma_\mu\gamma^5q$	$1/M_*^2$
D8	$\bar{\chi}\gamma^\mu\gamma^5\chi\bar{q}\gamma_\mu\gamma^5q$	$1/M_*^2$
D9	$\bar{\chi}\sigma^{\mu\nu}\chi\bar{q}\sigma_{\mu\nu}q$	$1/M_*^2$
D10	$\bar{\chi}\sigma_{\mu\nu}\gamma^5\chi\bar{q}\sigma_{\alpha\beta}q$	i/M_*^2
D11	$\bar{\chi}\chi G_{\mu\nu}G^{\mu\nu}$	$\alpha_s/4M_*^3$
D12	$\bar{\chi}\gamma^5\chi G_{\mu\nu}G^{\mu\nu}$	$i\alpha_s/4M_*^3$
D13	$\bar{\chi}\chi G_{\mu\nu}\tilde{G}^{\mu\nu}$	$i\alpha_s/4M_*^3$
D14	$\bar{\chi}\gamma^5\chi G_{\mu\nu}\tilde{G}^{\mu\nu}$	$\alpha_s/4M_*^3$
C1	$\chi^\dagger\chi\bar{q}q$	m_q/M_*^2
C2	$\chi^\dagger\chi\bar{q}\gamma^5q$	im_q/M_*^2
C3	$\chi^\dagger\partial_\mu\chi\bar{q}\gamma^\mu q$	$1/M_*^2$
C4	$\chi^\dagger\partial_\mu\chi\bar{q}\gamma^\mu\gamma^5q$	$1/M_*^2$
C5	$\chi^\dagger\chi G_{\mu\nu}G^{\mu\nu}$	$\alpha_s/4M_*^2$
C6	$\chi^\dagger\chi G_{\mu\nu}\tilde{G}^{\mu\nu}$	$i\alpha_s/4M_*^2$
R1	$\chi^2\bar{q}q$	$m_q/2M_*^2$
R2	$\chi^2\bar{q}\gamma^5q$	$im_q/2M_*^2$
R3	$\chi^2G_{\mu\nu}G^{\mu\nu}$	$\alpha_s/8M_*^2$
R4	$\chi^2G_{\mu\nu}\tilde{G}^{\mu\nu}$	$i\alpha_s/8M_*^2$

Dark Matter (EFT)

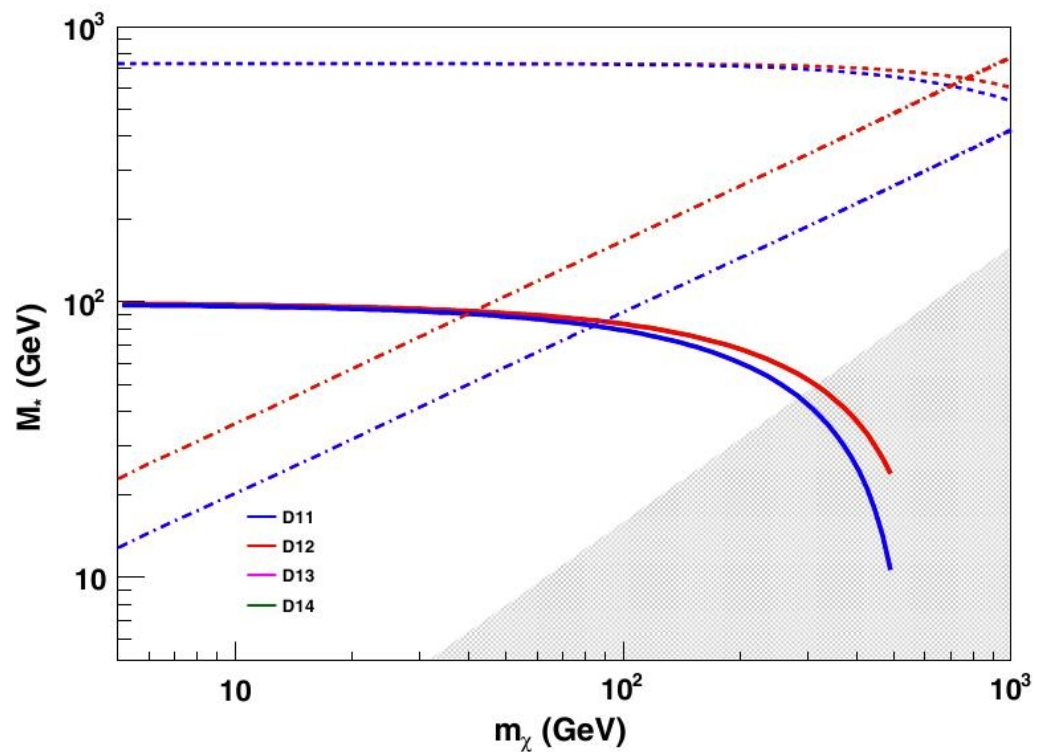
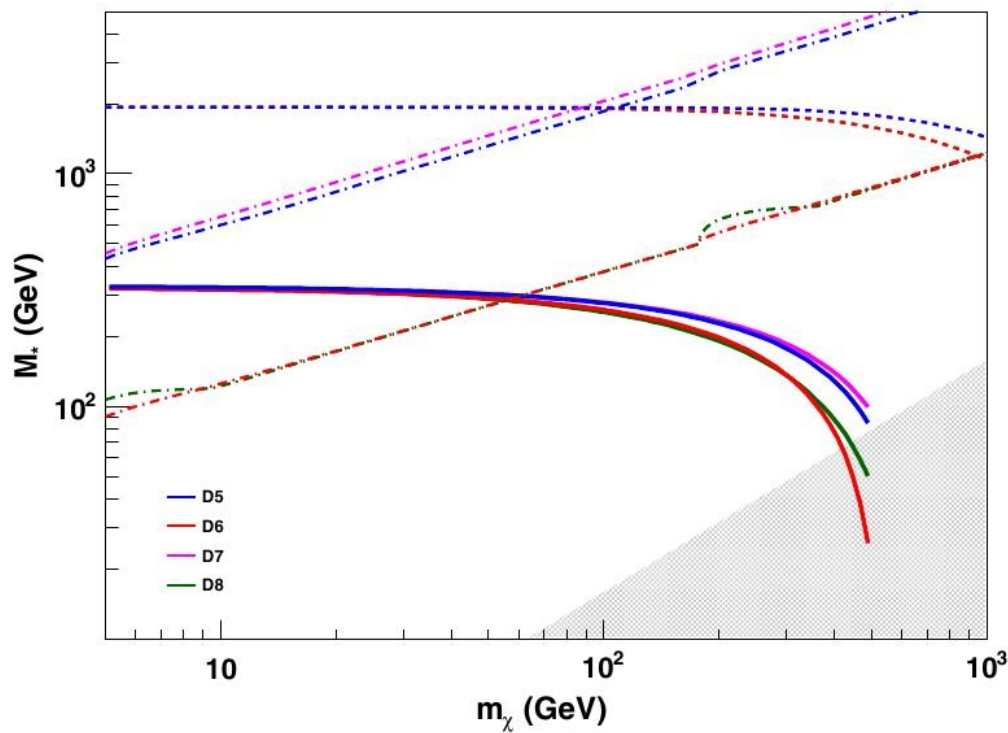
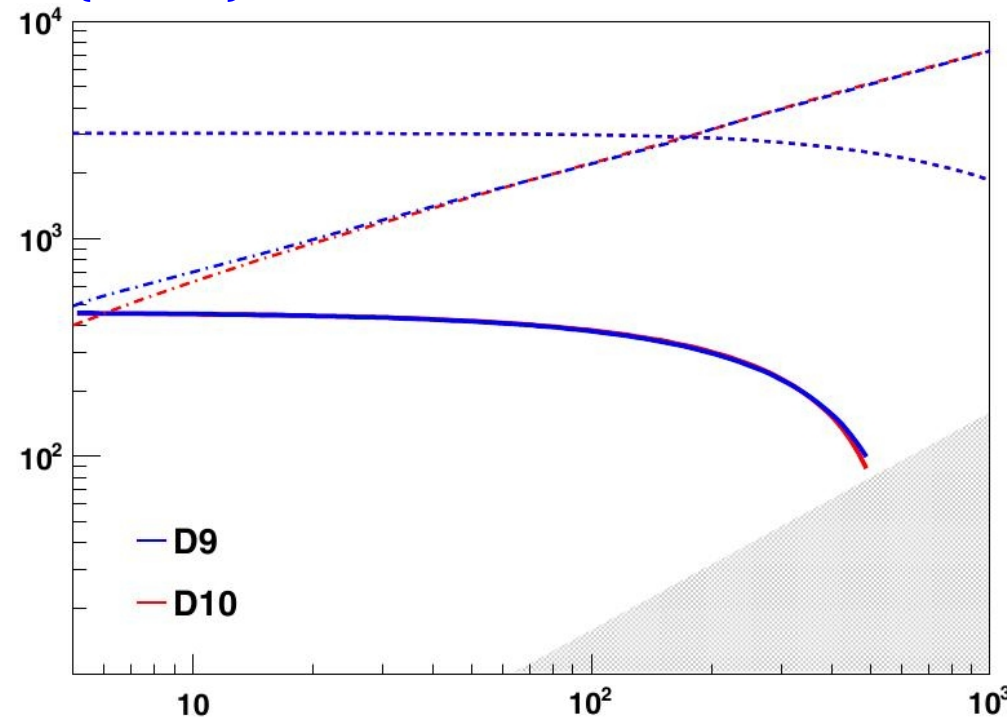
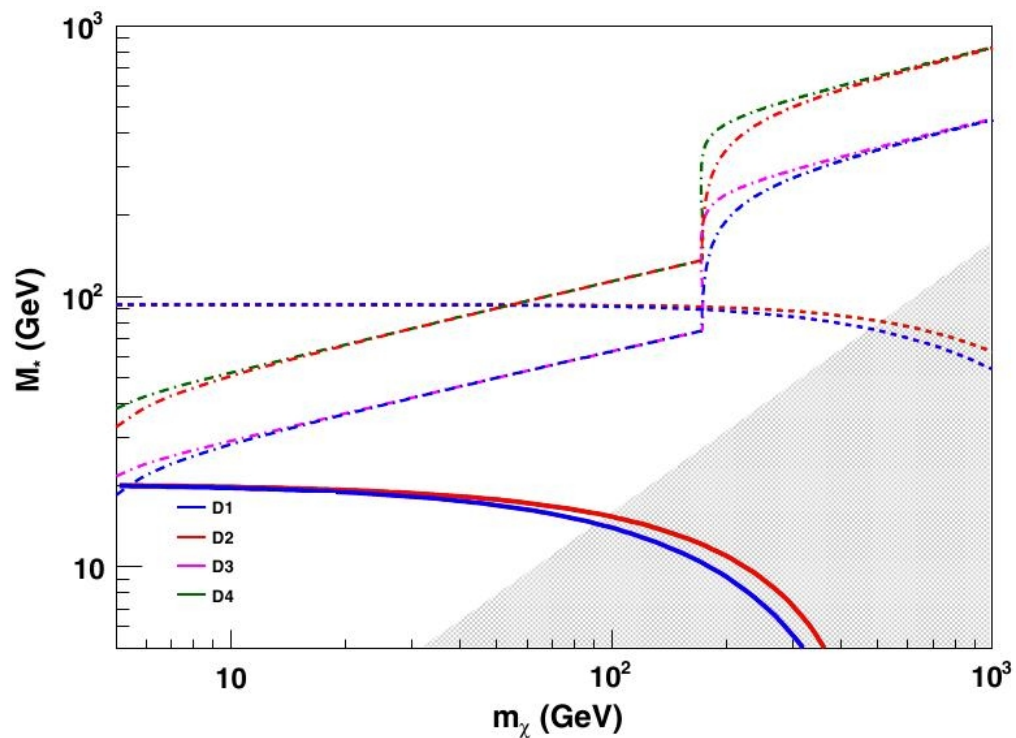

Dark Matter (EFT)

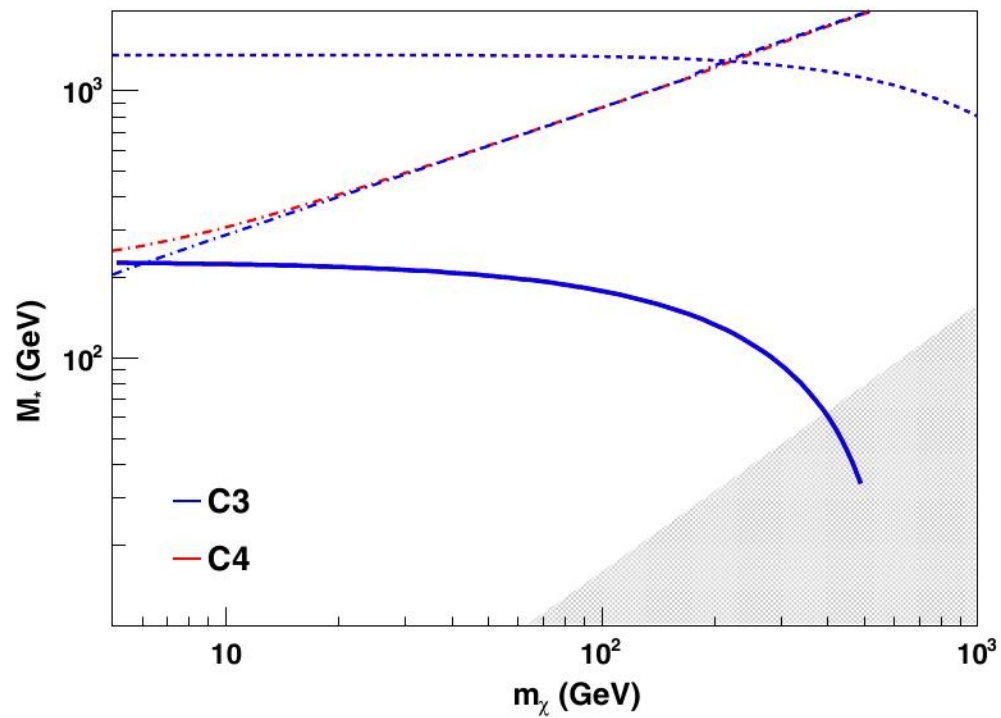
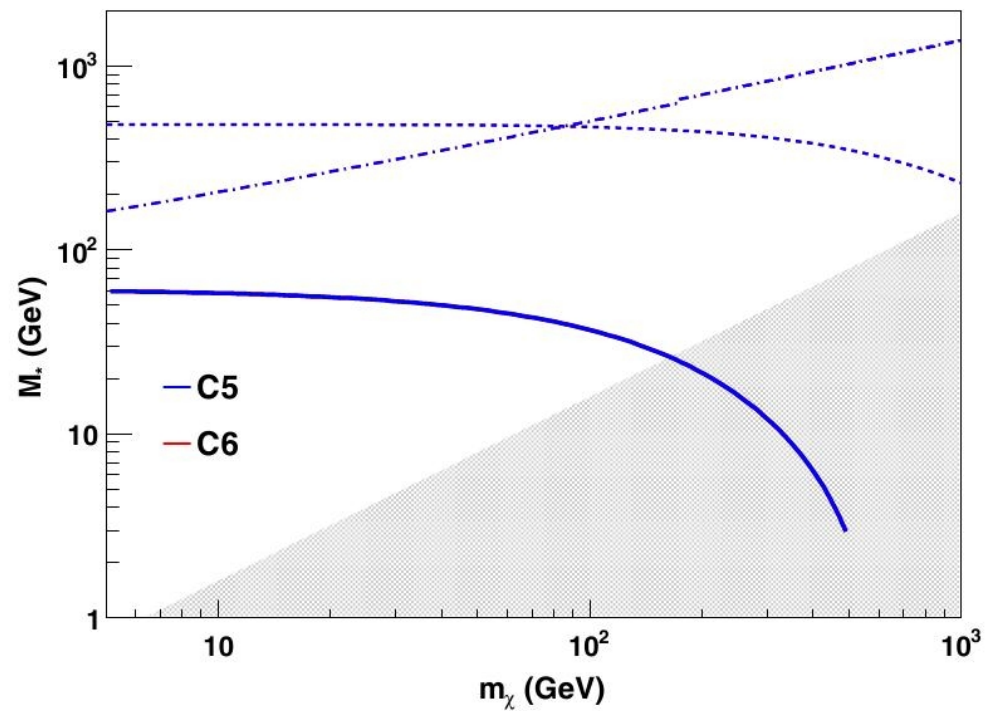
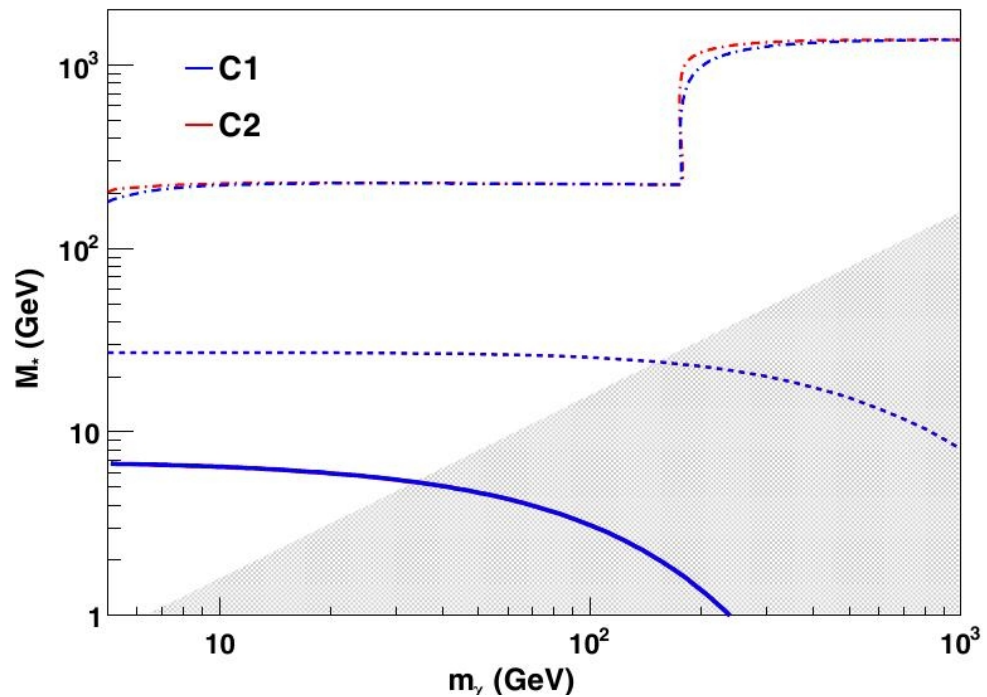

Dark Matter (EFT)

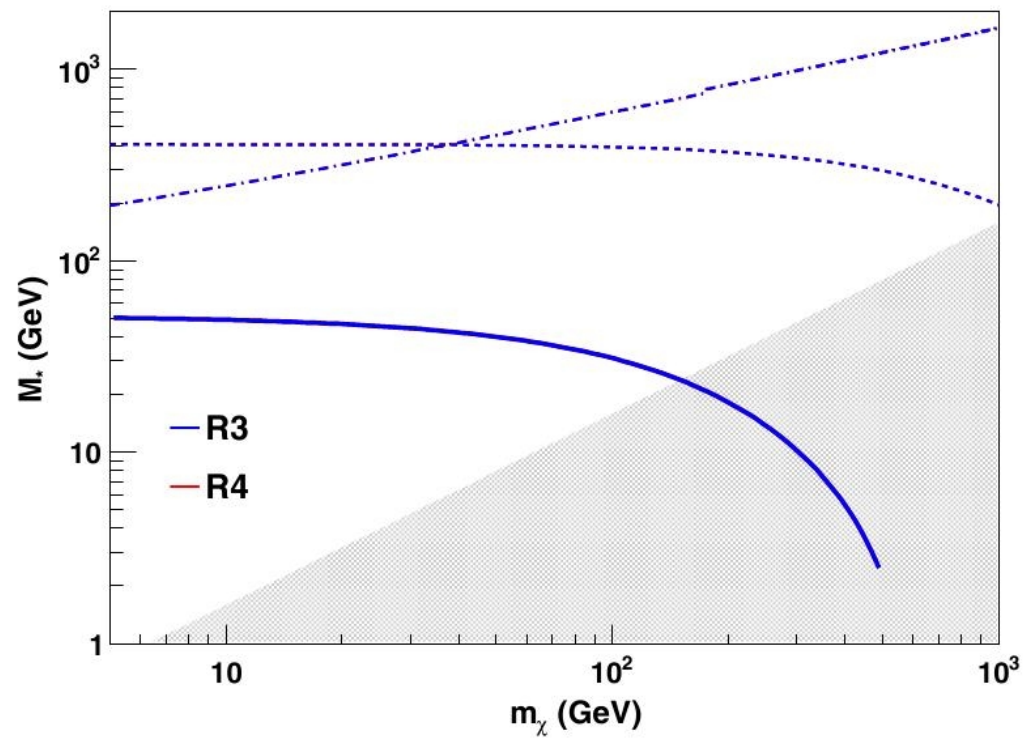
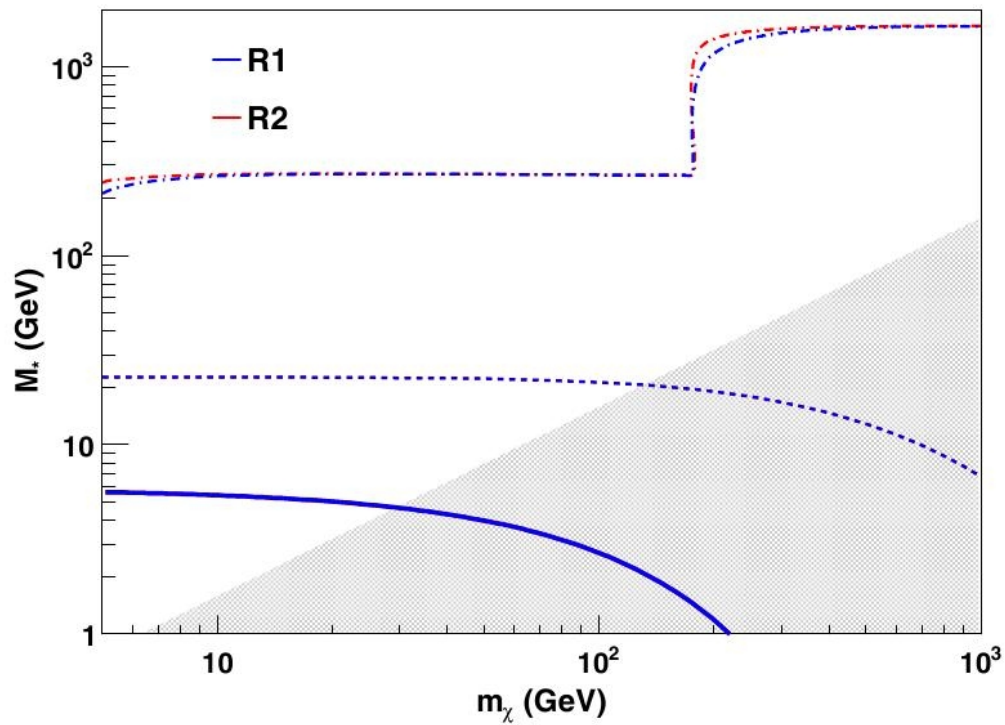

Dark Matter (EFT)

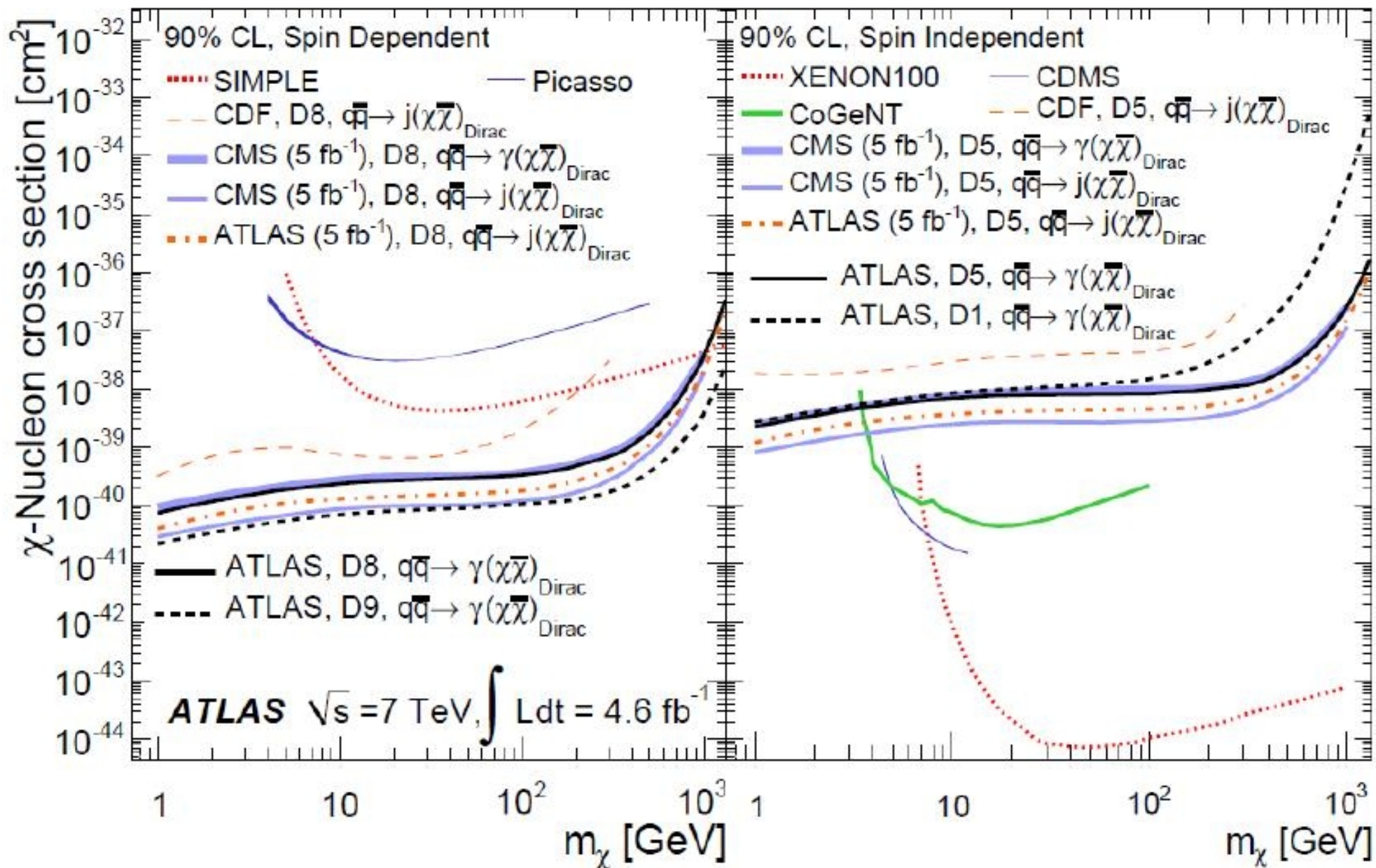

Dark Matter (EFT)

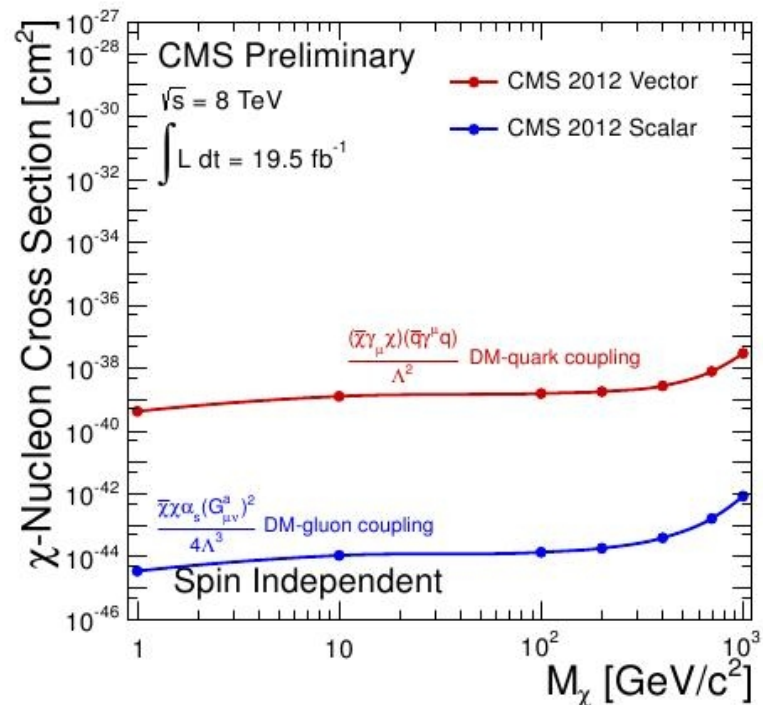
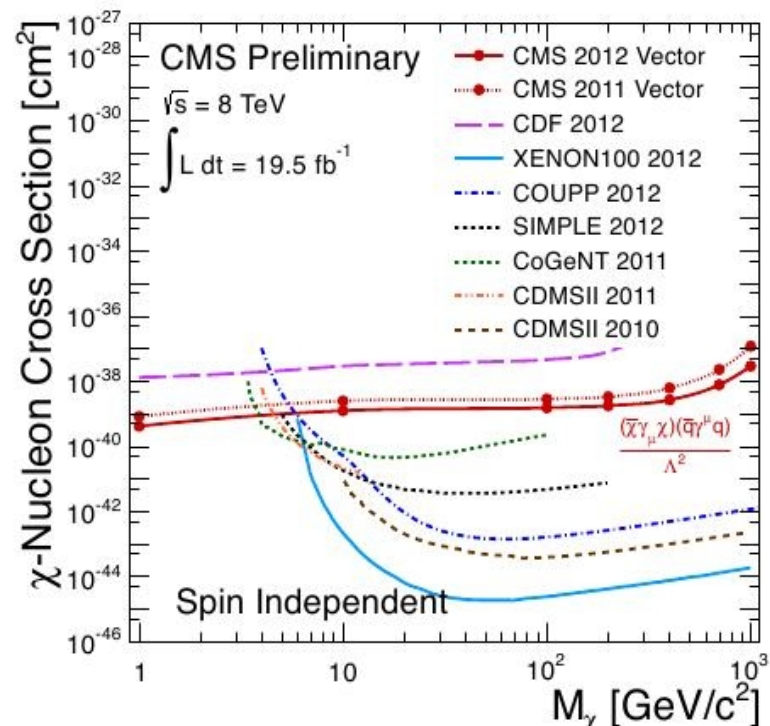
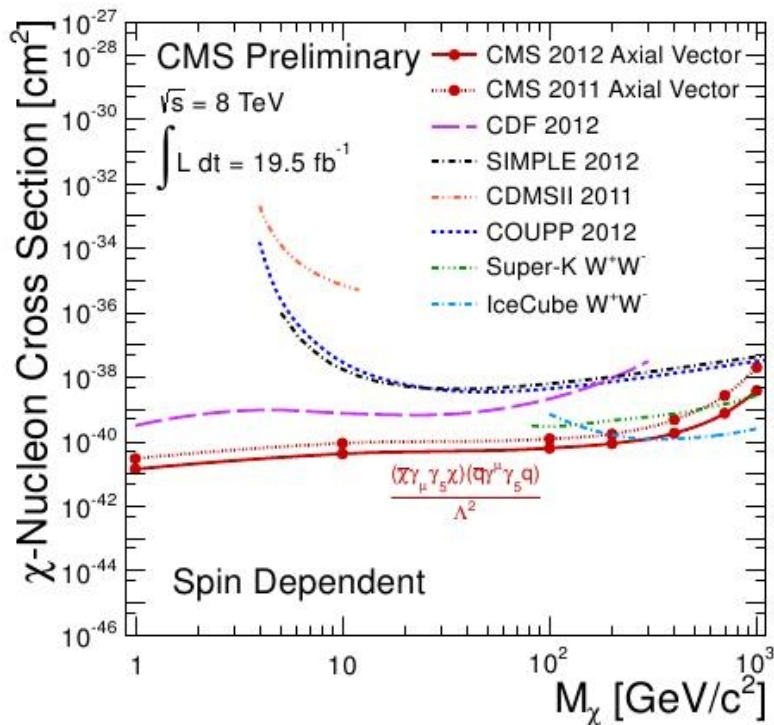

Limitations of EFT approaches

consider DM to be a fermion whose interaction with quarks are mediated by a heavy scalar particle S through the lagrangian :

$$L_{\text{UV}} = \frac{1}{2} M^2 S^2 - g_q \bar{q} q S - g_x \bar{\chi} \chi S$$

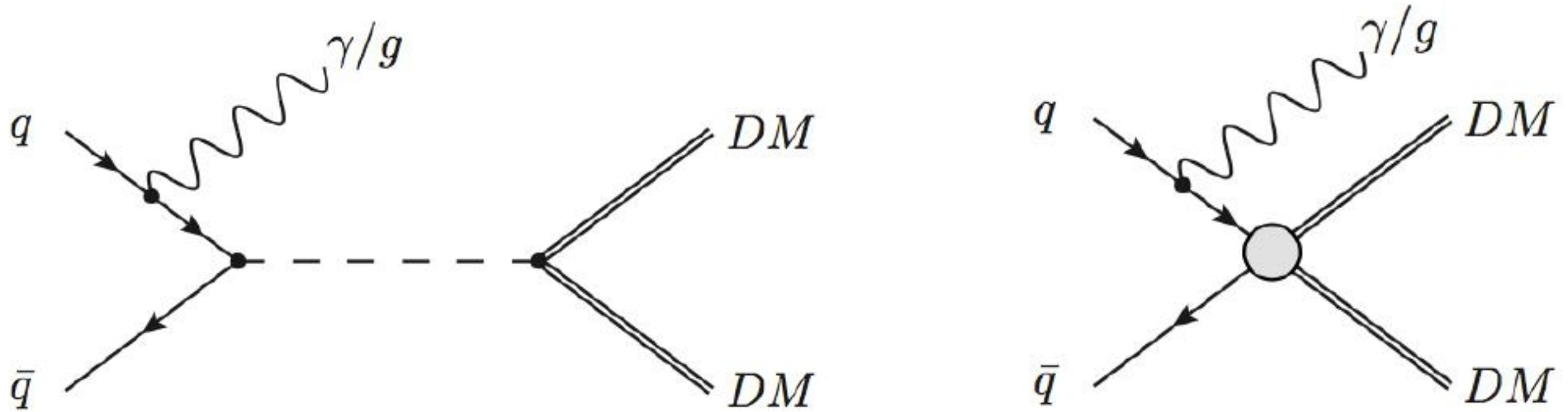

at energies much smaller than M the heavy mediator can be integrated out resulting in a tower of non renormalizable operators for DM interactions with quarks

\Rightarrow lowest-dimensional effective operator has dimension 6 : $O_S = \frac{1}{\Lambda^2} (\bar{\chi} \chi)(\bar{q} q)$
with $\frac{1}{\Lambda^2} = \frac{g_x g_q}{M^2}$

Limitations of EFT approaches

to assess the extent to which the effective description is valid one has to compare the momentum transfer Q_{tr} of the process of interest e.g. $pp \rightarrow \chi\chi + jet / \gamma$ to the energy scale and impose that $\Lambda > Q_{tr}$

one way of doing this is to consider ratio of Xsection obtained in EFT by imposing the constraint $Q_{tr} < \Lambda$ (on the PDF intregation domain) over the Xsection obtained with the EFT without such a constraint :

$$R_{\Lambda}^{\text{tot}} \equiv \frac{\sigma_{\text{eff}}|_{Q_{tr} < \Lambda}}{\sigma_{\text{eff}}} = \frac{\int_{p_T^{\text{min}}}^{1 \text{ TeV}} dp_T \int_{-2}^2 \frac{d^2 \sigma_{\text{eff}}}{dp_T d\eta} |_{Q_{tr} < \Lambda}}{\int_{p_T^{\text{min}}}^{1 \text{ TeV}} dp_T \int_{-2}^2 \frac{d^2 \sigma_{\text{eff}}}{dp_T d\eta}}$$

Limitations of EFT approaches

contours indicate the regions in the parameter space (Λ, m_{DM}) where the description in terms of effective operator is accurate and reliable

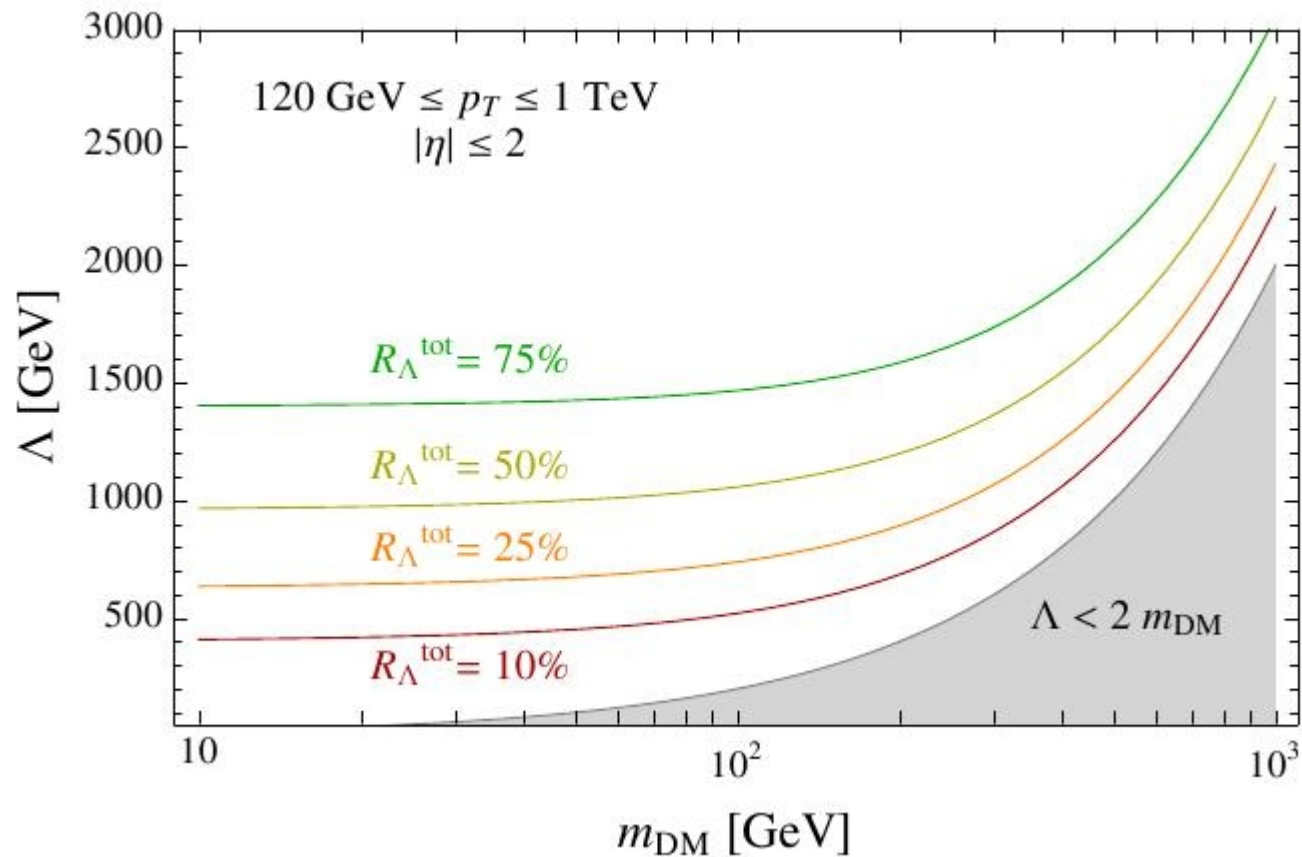

even for very small DM masses having R_Λ^{tot} at least 75% requires a cutoff scale at least above 1 TeV

Limitations of EFT approaches

one can also compare the effective operator with a UV completion (i.e. L_{UV})
for example :

$$r_{\text{UV/eff}} \equiv \frac{\left. \frac{d^2 \sigma_{\text{UV}}}{d p_T d \eta} \right|_{Q_{\text{tr}} < M}}{\left. \frac{d^2 \sigma_{\text{eff}}}{d p_T d \eta} \right|_{Q_{\text{tr}} < \Lambda}}$$

helps in quantifying the error using the EFT truncated at the lowest-dimensional operator w.r.t its UV completion (for given p_T , η of the radiated object)

values of $r_{\text{UV/eff}}$ close to unity indicate the effective operator is accurately describing the high energy theory, whereas larger values imply a poor effective description

Limitations of EFT approaches

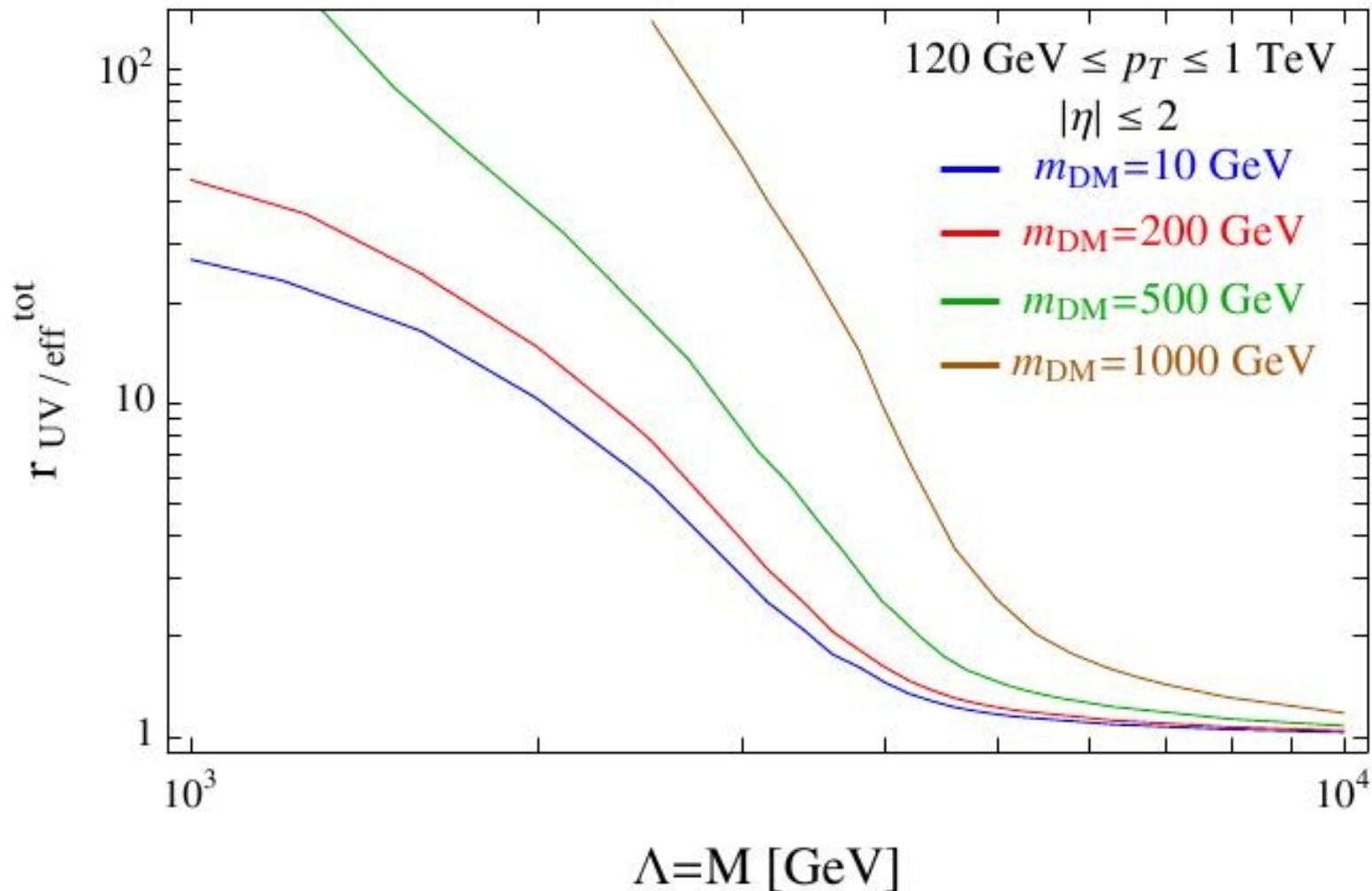

in this example (with these numerical inputs) EFT seems to be valid when mediator has mass greater than 2-2.5 TeV

Limitations of EFT approaches

further caution when comparing only the EFT limit with direct searches from a study of monojet searches at LHC interpreted in terms of DM for vector and axial vector interactions :

- EFT valid when mediator has mass greater than 2.5 TeV
- current limits on the contact interaction scale Λ in EFT apply to theories that are perturbative for DM mass $m_{DM} < 800$ GeV
- however for all values of m_{DM} mediator width tends to be greater than the mass \Rightarrow particle-like interpretation of mediator is doubtful
- furthermore consistency with thermal relic density occurs only for

$$170 < m_{DM} < 520 \text{ GeV}$$

- for lighter mediator masses EFT limit:
 - either under-estimate true limit - because process is resonantly enhanced
 - either over-estimate it - because missing energy distribution is too soft

ADM and conventional EFT approaches

shaded area : region consistent with sufficiently annihilating the symmetric abundance and satisfying all the constraints

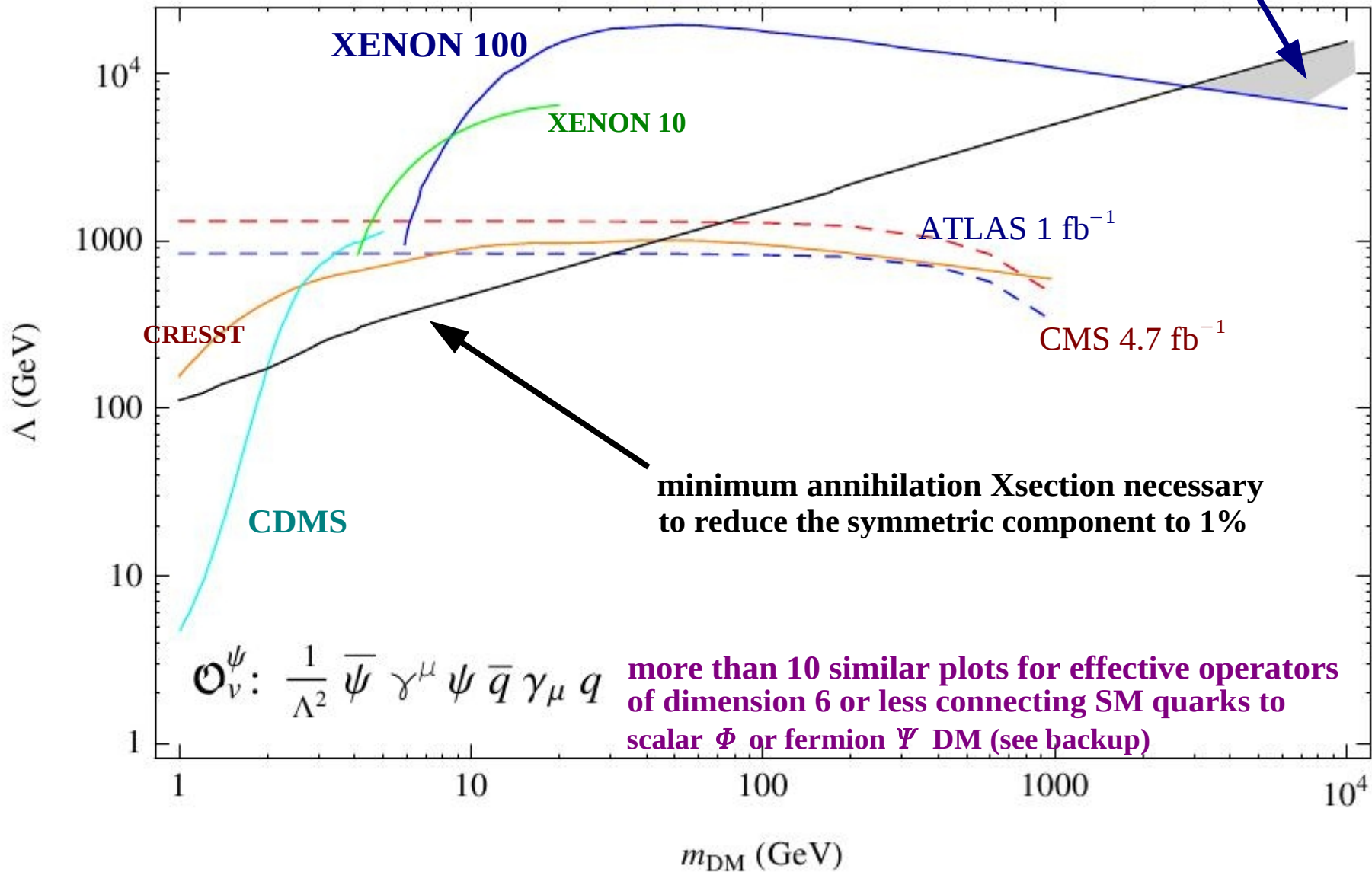

ADM and conventional EFT approaches

- from this analysis: demanding efficient annihilation of the symmetric component seems to lead to tension with experimental limits if the annihilation is directly to SM particles
- EFT analysis of model independent constraints on ADM from direct detection and LHC monojet searches
 - exclude models of ADM with mass $1 < m_{\text{DM}} < 100 \text{ GeV}$ annihilating to SM quarks via heavy mediator
 - experimental constraints on theories of ADM require that the DM part be part of a richer hidden sector of interacting states of comparable mass or lighter
- constraints are much weakened for lighter particle (including mediator) especially when the mediator particle is on resonance $m_M = 2 m_X$ (however look at constraints from lower energy $e^+ e^-$ machine experiments such as Babar & Belle

Other constraints on low mass DM

comparing neutrino fluxes generated by solar models with observations
i.e. ${}^8\text{B}$ neutrino fluxes

⇒ non annihilating DM particles with :

$$M_{DM} < 10 \text{ GeV}$$

$$\sigma^{SI} > 3 \times 10^{-37} \text{ cm}^{-2}$$

produce a variation in ${}^8\text{B}$ neutrino fluxes in conflict with current measurements

i.e. accumulation of non annihilating light DM (5-16 GeV) produces a decrease in the central temperature of a few % which can be measured in solar neutrino fluxes

many constraints coming from stars (including sun) observation

⇒ example : bosonic ADM excluded in the range 2 keV - 16 GeV
from neutron stars

Where is dark matter ?

- the WIMP miracle (reminder)

 - back to MSSM

 - relic density

 - interaction with matter

- some recent non-accelerator experimental results (summer 13')

- some global fits

 - CMSSM (frequentist and Bayesian)

 - beyond CMSSM and MSSM

- invisible Higgs

- 2 examples from extra dimensions

- asymmetric DM

- effective field theory approaches (and limitations)

- **possible searches at lepton colliders**

at low energy lepton colliders

monophoton as (very) light (fermionic) DM (LDM) signal

$\chi \rightarrow$ DM particle with mass m_χ

$A' \rightarrow$ mediator with mass $m_{A'}$

$g_e \rightarrow$ coupling of mediator to electron

$g_\chi \rightarrow$ coupling of mediator to LDM with $g_\chi < \sqrt{4\pi}$ (perturbativity)

$\epsilon \rightarrow$ SM fermions of charge q_i couple to mediator with $g_e = \epsilon e q_i$

when $m_{A'} \gg \sqrt{s}$, mediator is integrated out

\Rightarrow for fermionic LDM coupling through vector, axial scalar or pseudo-scalar mediator effective operators describing the interactions are (resp):

$$O_V = \frac{1}{\Lambda^2} (\bar{\chi} \gamma_\mu \chi) (\bar{e} \gamma^\mu e), \quad O_A = \frac{1}{\Lambda^2} (\bar{\chi} \gamma_\mu \gamma^5 \chi) (\bar{e} \gamma^\mu \gamma^5 e)$$

$$O_S = \frac{1}{\Lambda^2} (\bar{\chi} \chi) (\bar{e} e), \quad O_{PS} = \frac{1}{\Lambda^2} (\bar{\chi} \gamma^5 \chi) (\bar{e} \gamma^5 e)$$

with $\Lambda \equiv \frac{m_{A'}}{\sqrt{g_e g_\chi}}$

- signal spectrum depends on m_χ and the rate is proportional to Λ^{-4}

with correction of order $m_{\chi\bar{\chi}}^2/m_{A'}^2$, relevant only for A' masses close to center of mass energy

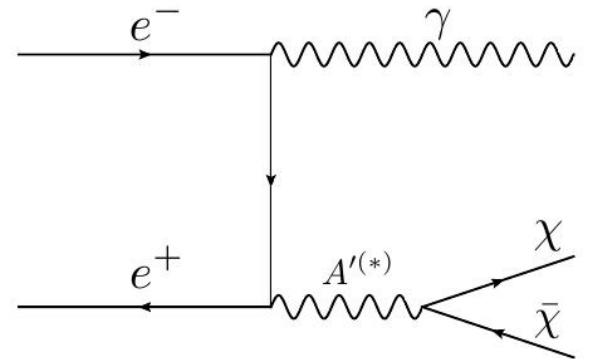
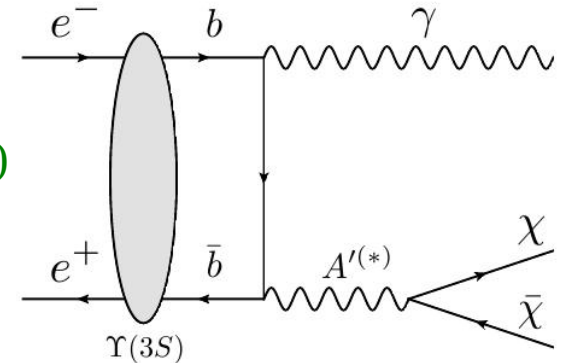

at low energy lepton colliders

- for mediators produced on shell

m_χ and g_χ are irrelevant as long as mediator does not have a significant branching to SM fermions

signal spectrum is controlled by $m_{A'}$,

rate is proportional to g_e^2 with correction of order $\frac{g_e^2}{g_\chi^2}$

- for $m_{A'} \ll m_\chi$

signal spectrum depends on m_χ but not so much on $m_{A'}$,

rate is proportional to $(g_e g_\chi)^2$ with correction of order $\frac{m_{A'}^2}{m_{\chi\bar{\chi}}^2}$

at low energy lepton colliders

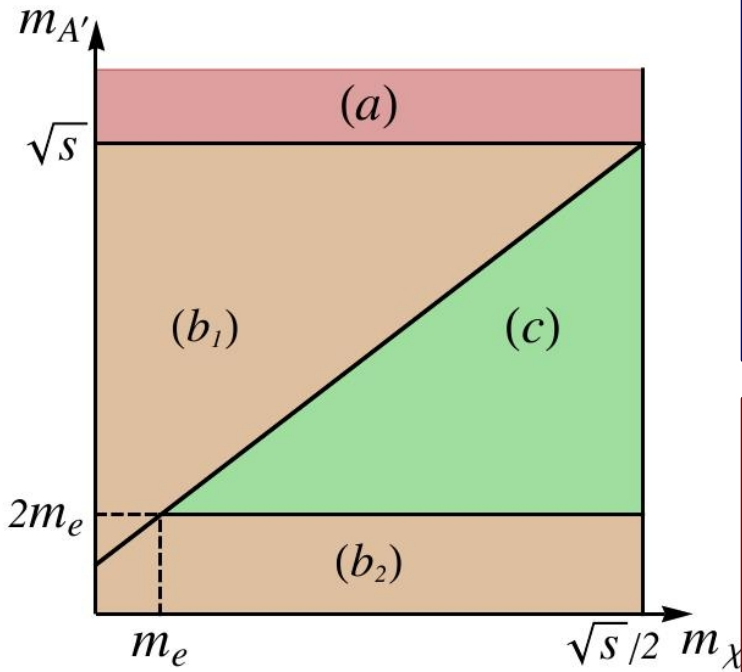

region a) : mediator too heavy to be produced on shell
 $\chi\bar{\chi}$ production via off-shell mediator
 γ dominantly produced as ISR
 with spectrum rising towards low energies (high $m_{\chi\bar{\chi}}$)

$$\sqrt{s} > m_{A'} > 2m_\chi \quad \text{or} \quad m_{A'} < 2m_e$$

region b1) : mediator decays to $\chi\bar{\chi}$
 BR to SM particle assumed to be negligible

region b2) : too light to decay into either $\chi\bar{\chi}$ or e^+e^-
 A' is hidden-photon-like i.e. decaying into 3 γ outside detector

both case $\Rightarrow \gamma + \text{MET signature}$ ($e^+e^- \rightarrow \gamma A'$)
 spectrum peaked at $m_{\chi\bar{\chi}}^2 = m_{A'}^2$, modulo detector resolution

region c) : $2m_\chi > m_{A'} > 2m_e$

mediator can be produced on shell but too light to decay to $\chi\bar{\chi}$
 could decay into other light hidden sector particle (if exists)
 or to SM particles (depending on couplings)

at low energy lepton colliders

upper bound on g_e as a function of $m_{A'}$
for on shell light mediator (region b)

projected upper limit from an 'improved Babar' analysis
for vector and axial mediator where background has been
reduced by a factor 10

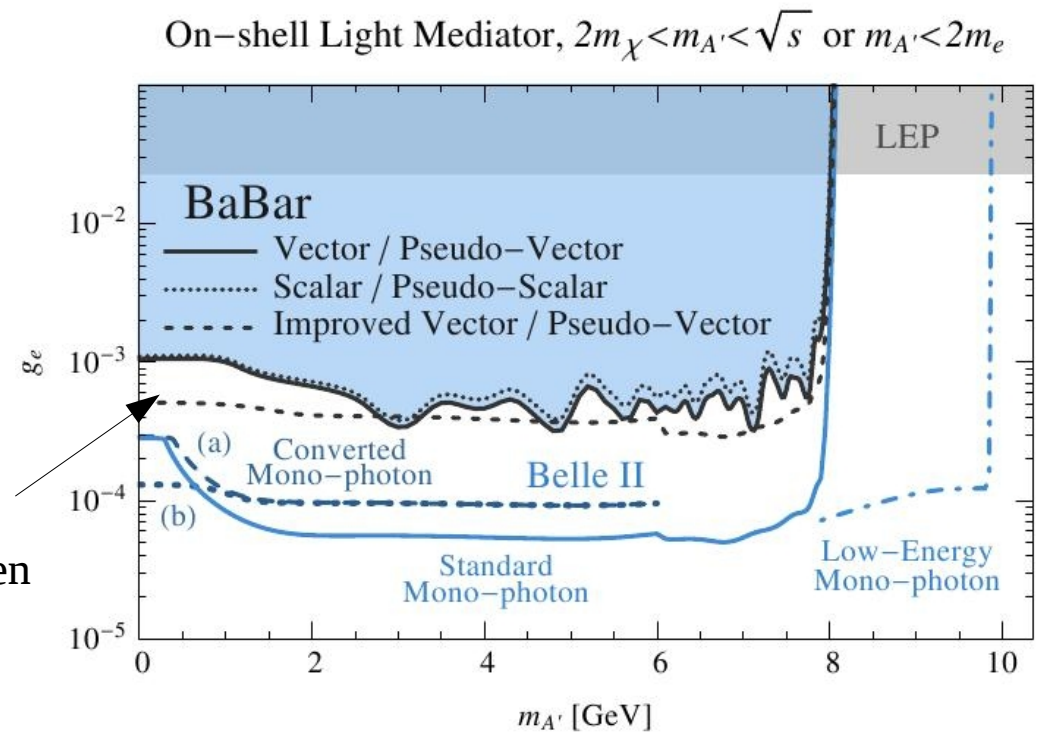

upper bound on $g_e g_\chi$ as a function of $m_{A'}$
for the off shell mediator region (region c)
with $m_{A'} = 100$ MeV

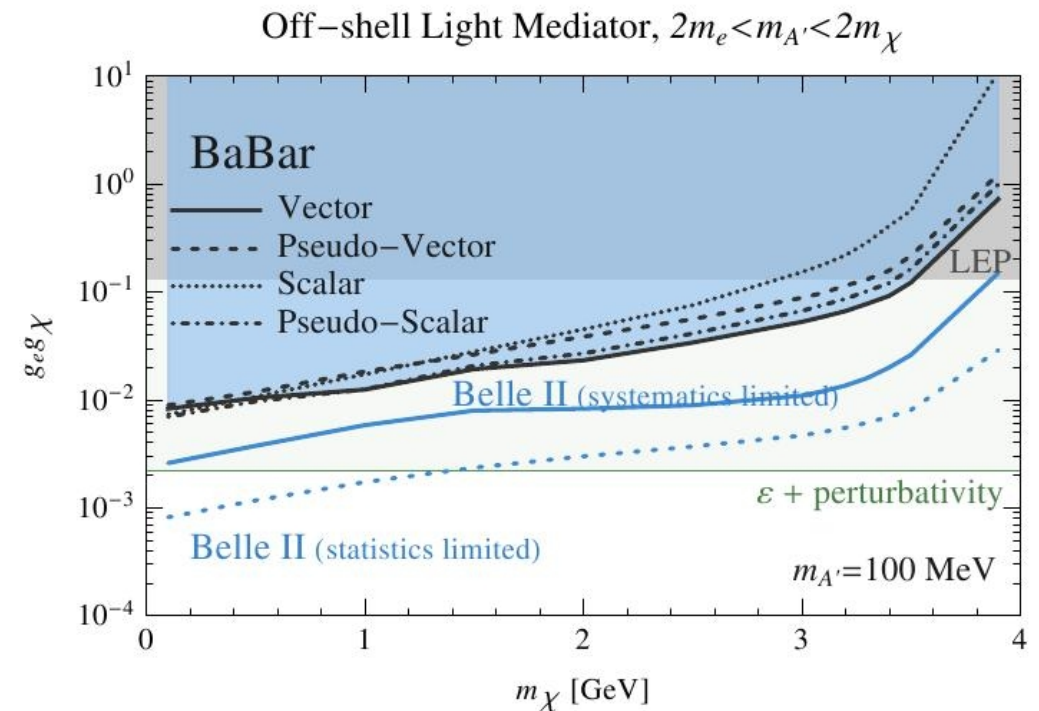

at low energy lepton colliders

3 GeV vector mediator (electron scattering)

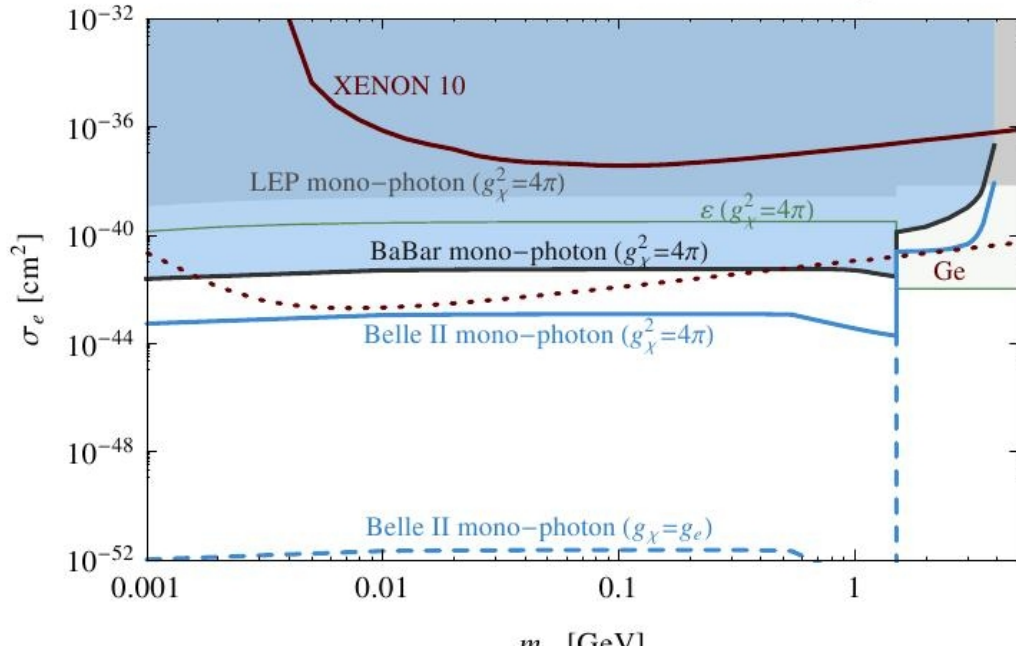

3 GeV vector mediator (S.I. proton scattering)

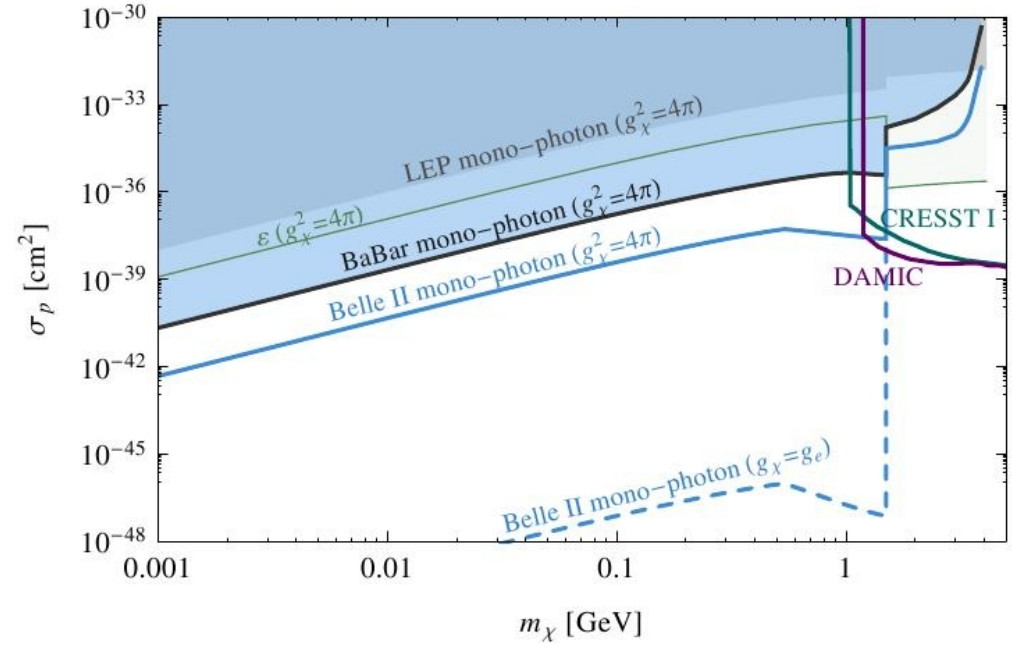

300 MeV vector mediator (electron scattering)

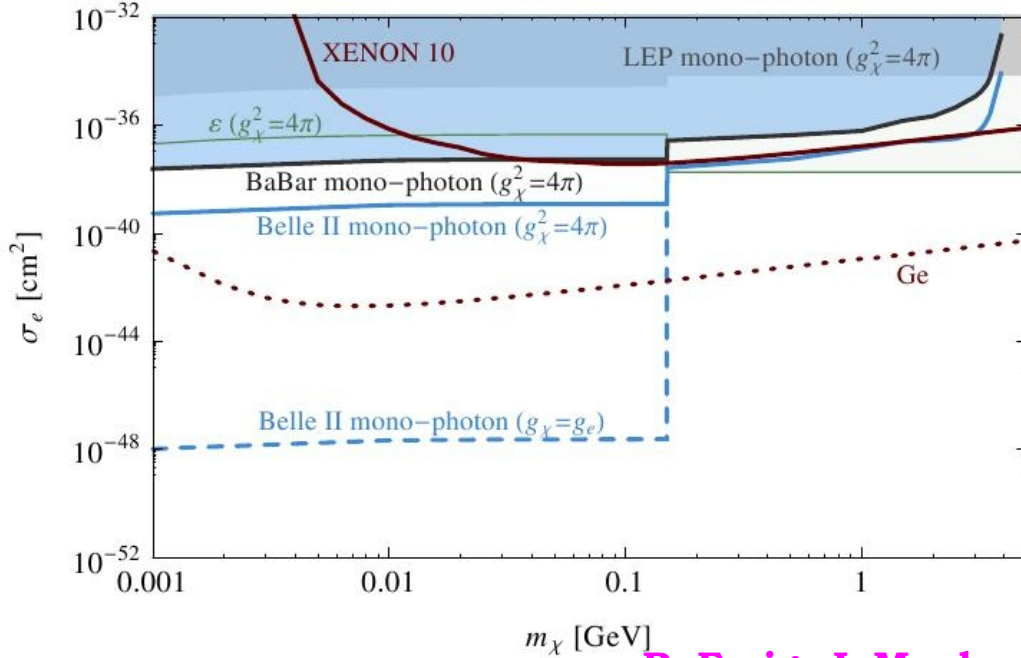

300 MeV vector mediator (S.I. proton scattering)

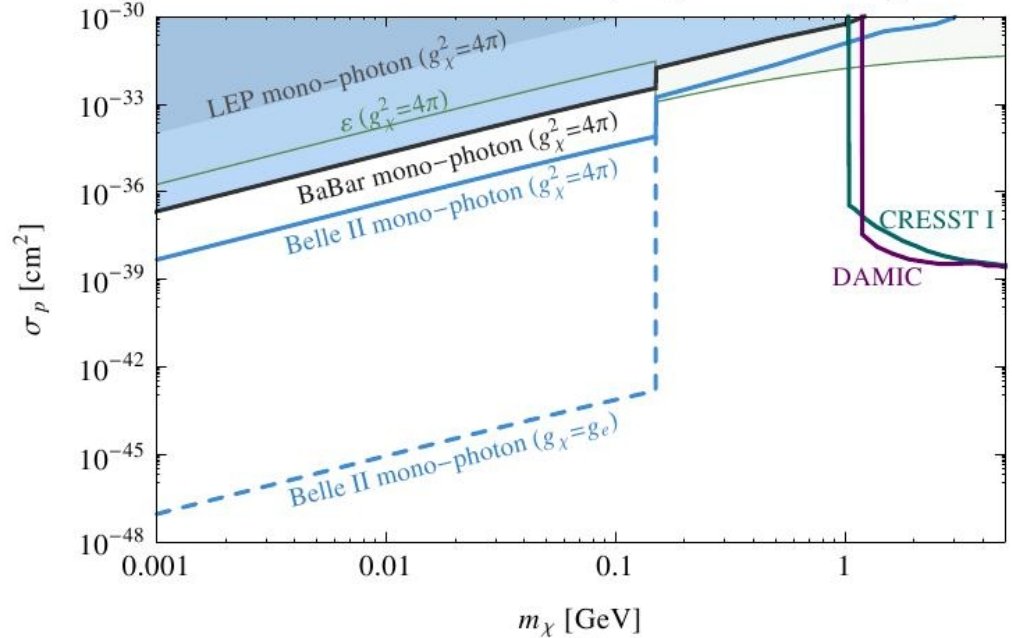

at high energy lepton colliders

monophoton also as DM signal

at high energy $e^+ e^-$ colliders

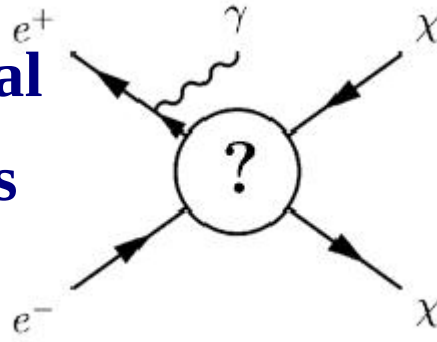

$$\frac{d\sigma(e^+ e^- \rightarrow 2\chi\gamma)}{dx d\cos\theta} \approx \frac{\alpha \kappa_e \sigma_{ann}}{16\pi} \frac{1 + (1-x)^2}{x} \frac{1}{\sin^2\theta} 2^{2J_o} (2S_x + 1)^2 \times \left(\frac{1 - 4M_x^2}{(1-x)s} \right)^{1/2+J_o}$$

with $x = 2 \frac{E_\gamma}{\sqrt{s}}$, S_x spin of the WIMP, κ_e fraction

of annihilation into electrons of the total DM annihilation rate,

$J_o=0$ for s-wave and $J_o=1$ for p-wave annihilation

error bars illustrate a 10% uncertainty

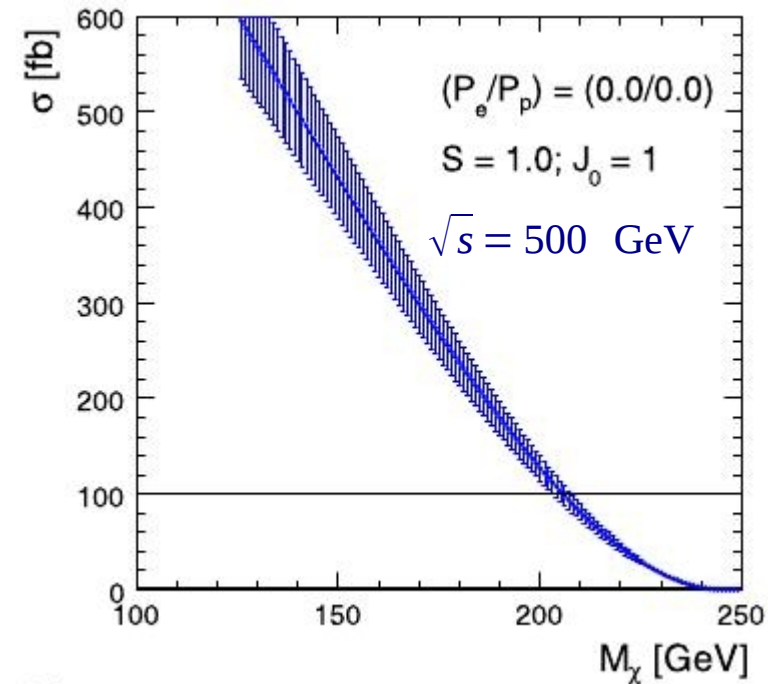
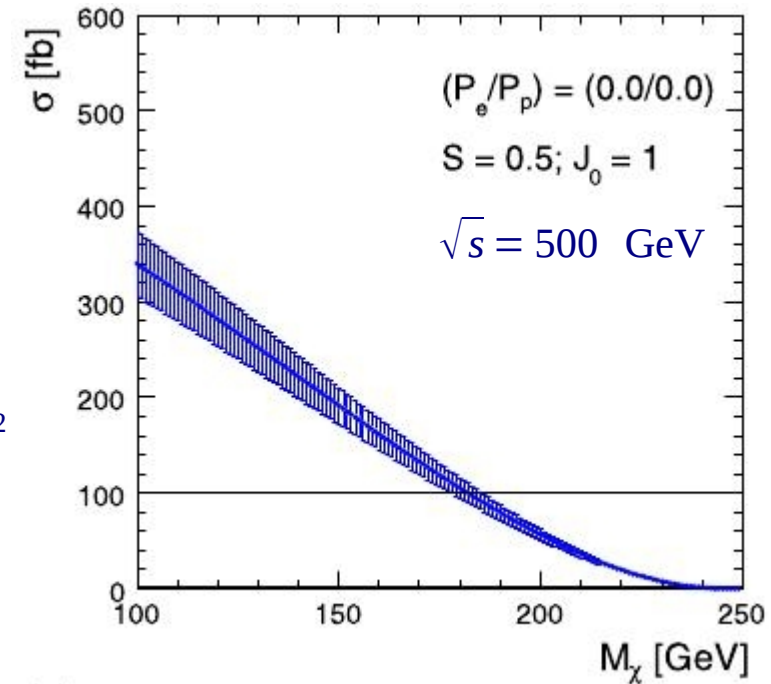

Dark Matter at high energy lepton colliders

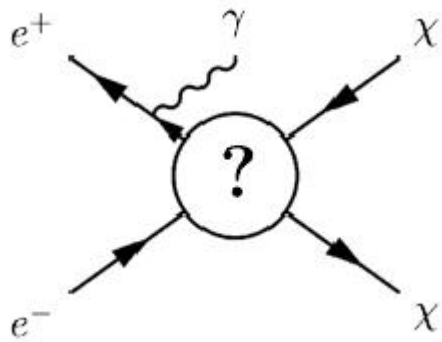

e.g. in MSSM

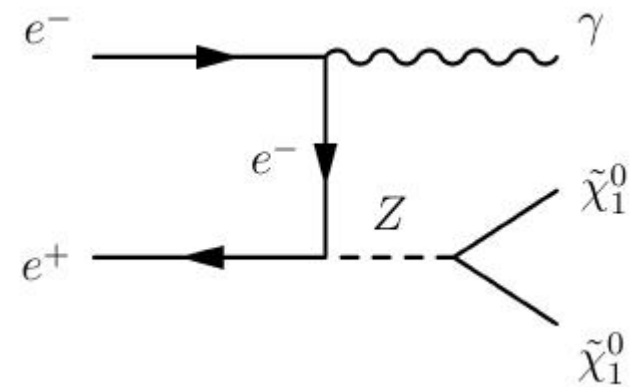
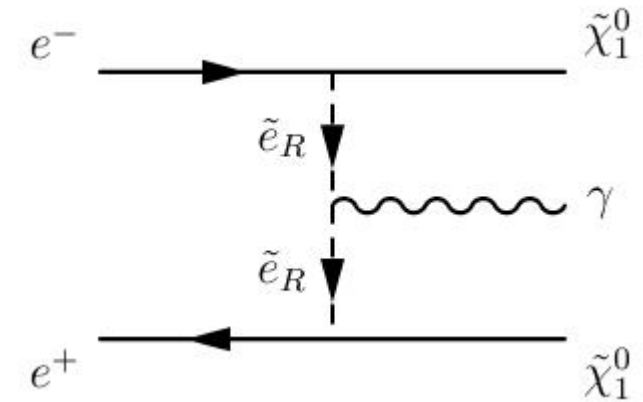
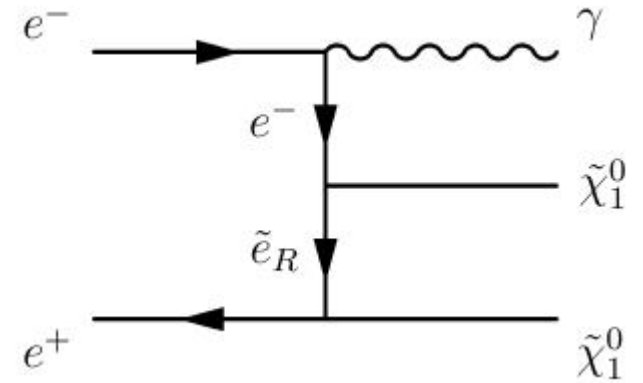
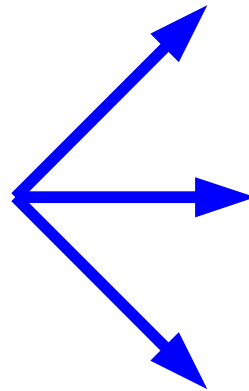

Dark Matter at high energy lepton colliders

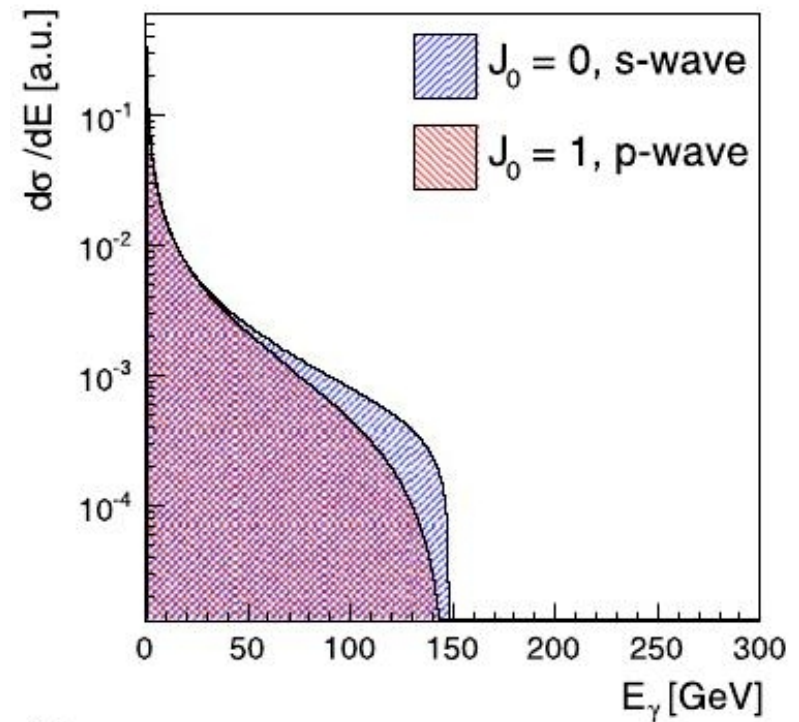
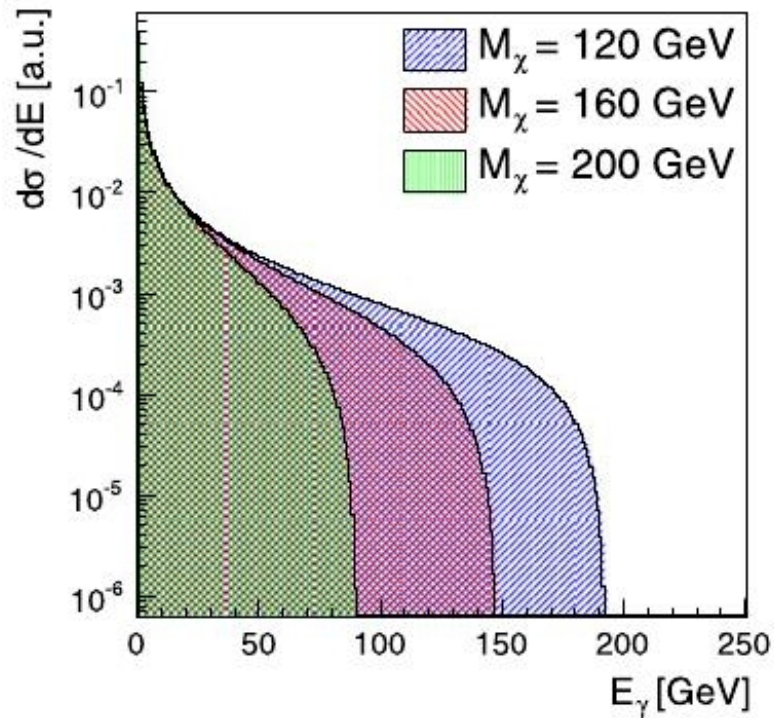

example of photon energy spectra

Dark Matter at high energy lepton colliders

main irreducible background $e^+ e^- \rightarrow \nu \bar{\nu} \gamma$

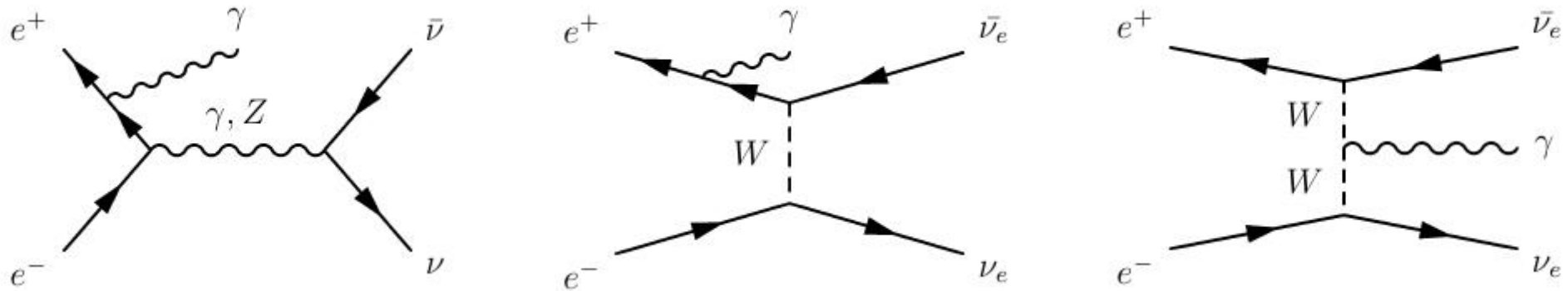

use of beam polarization helps

Process	Cross sections [fb] for $(P_{e^-}; P_{e^+}) =$		
	$(-0.8; +0.3)$	$(+0.0; +0.0)$	$(+0.8; -0.3)$
$\nu \bar{\nu} \gamma$	5821	2575	1263
$\nu \bar{\nu} \gamma \gamma$	782.0	355.4	214
$\nu \bar{\nu} \gamma \gamma \gamma$	55.8	26.2	19
$\gamma \gamma$		11.4×10^3	
$\gamma \gamma \gamma$		1.1×10^3	
$\gamma \gamma \gamma \gamma$		0.1×10^3	
$e^+ e^-$		890×10^3	

Dark Matter at high energy lepton colliders

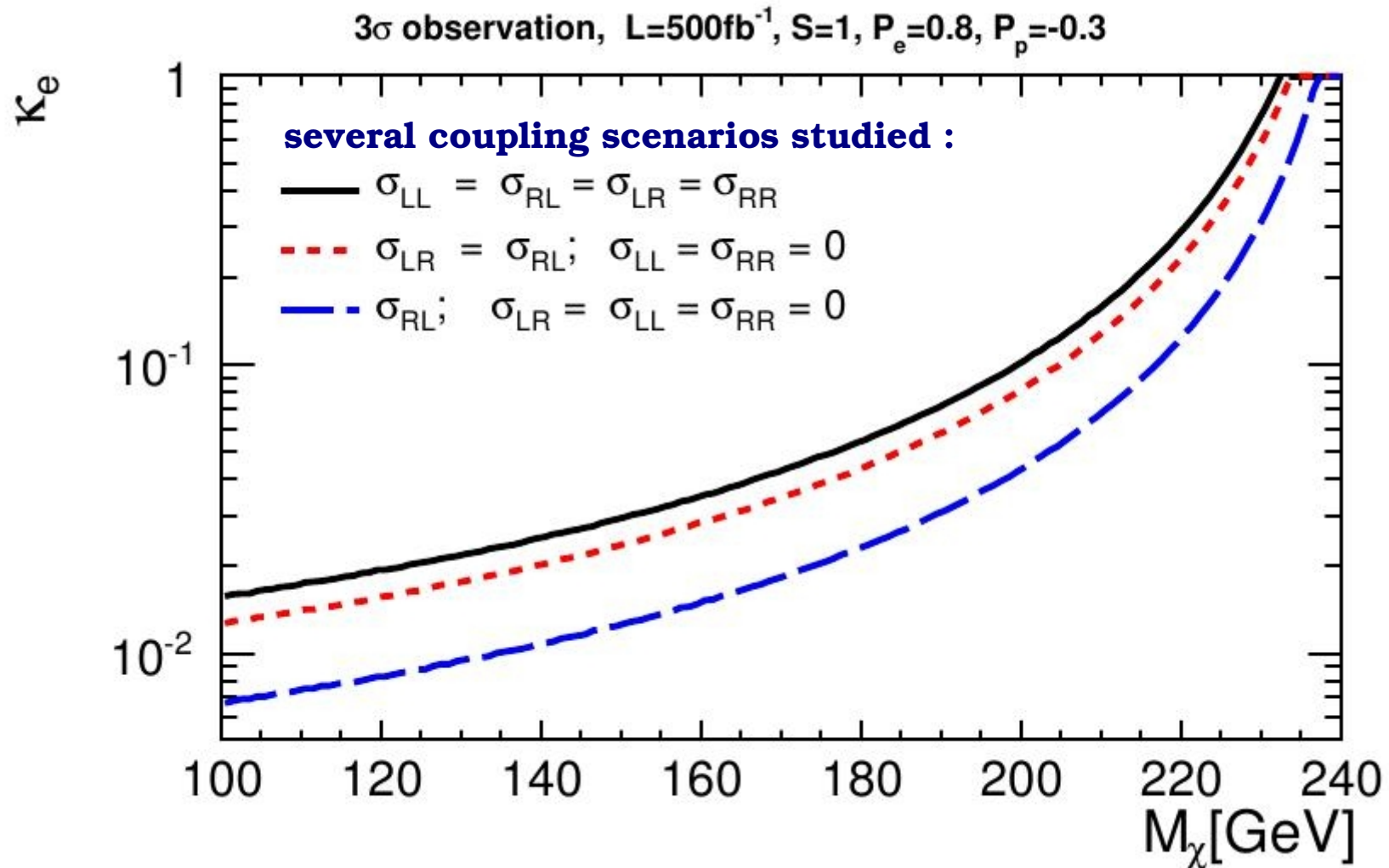

Dark Matter at high energy lepton colliders

relative uncertainty on the reconstructed

WIMP mass (blue syst. and red stat.)

as a function of the true mass

several coupling scenarios studied :

'Equal' : WIMP couplings independent of the helicity of the incoming e^- and e^+

$$\kappa(e_R^-, e_L^+) = \kappa(e_R^-, e_R^+) = \kappa(e_L^-, e_L^+) = \kappa(e_L^-, e_R^+)$$

'Helicity' : couplings conserve helicity and parity

$$\kappa(e_R^-, e_L^+) = \kappa(e_L^-, e_R^+) \quad ; \quad \kappa(e_R^-, e_R^+) = \kappa(e_L^-, e_L^+) = 0$$

'Anti-SM' : WIMP couples only to e_R^- and e_L^+

$$\kappa(e_R^-, e_L^+) \quad \text{all other } \kappa(e^-, e^+) = 0$$

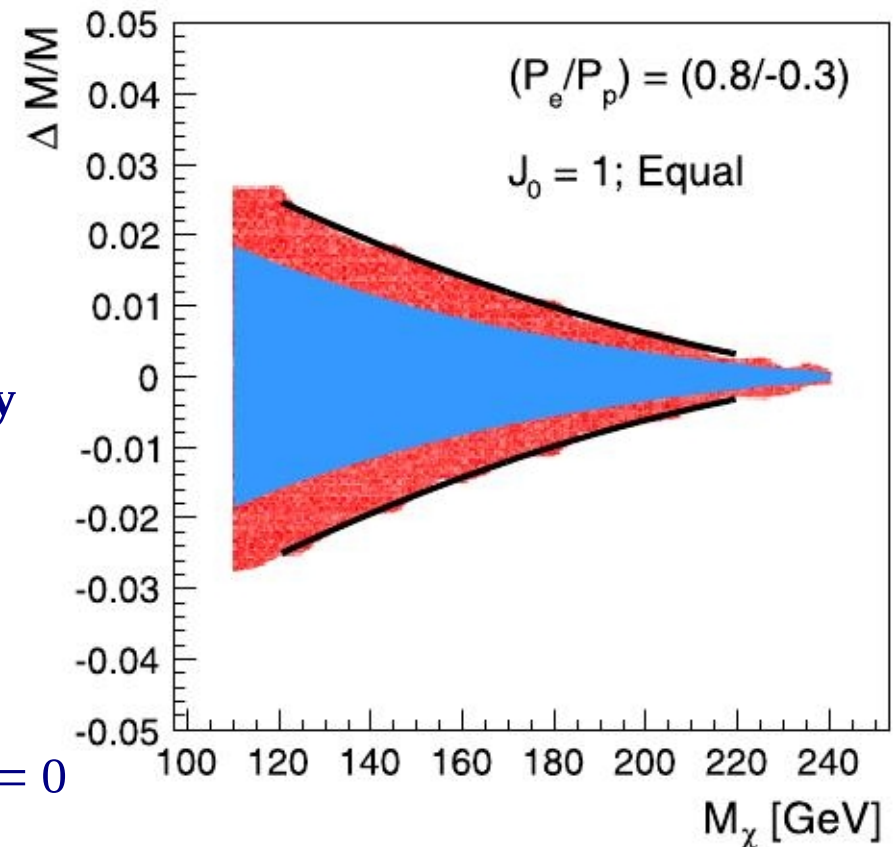

Dark Matter at high energy lepton colliders

$$L_{\text{int}} = \frac{1}{\Lambda^2} O_i$$

$$O_{\text{vector}} = (\bar{\chi} \gamma_\mu \chi) (\bar{l} \gamma^\mu l)$$

$$O_{\text{scalar s-channel}} = (\bar{\chi} \chi) (\bar{l} l)$$

$$O_{\text{axial}} = (\bar{\chi} \gamma_\mu \gamma_5 \chi) (\bar{l} \gamma^\mu \gamma^5 l)$$

$$O_{\text{scalar t-channel}} = (\bar{\chi} l) (\bar{l} \chi)$$

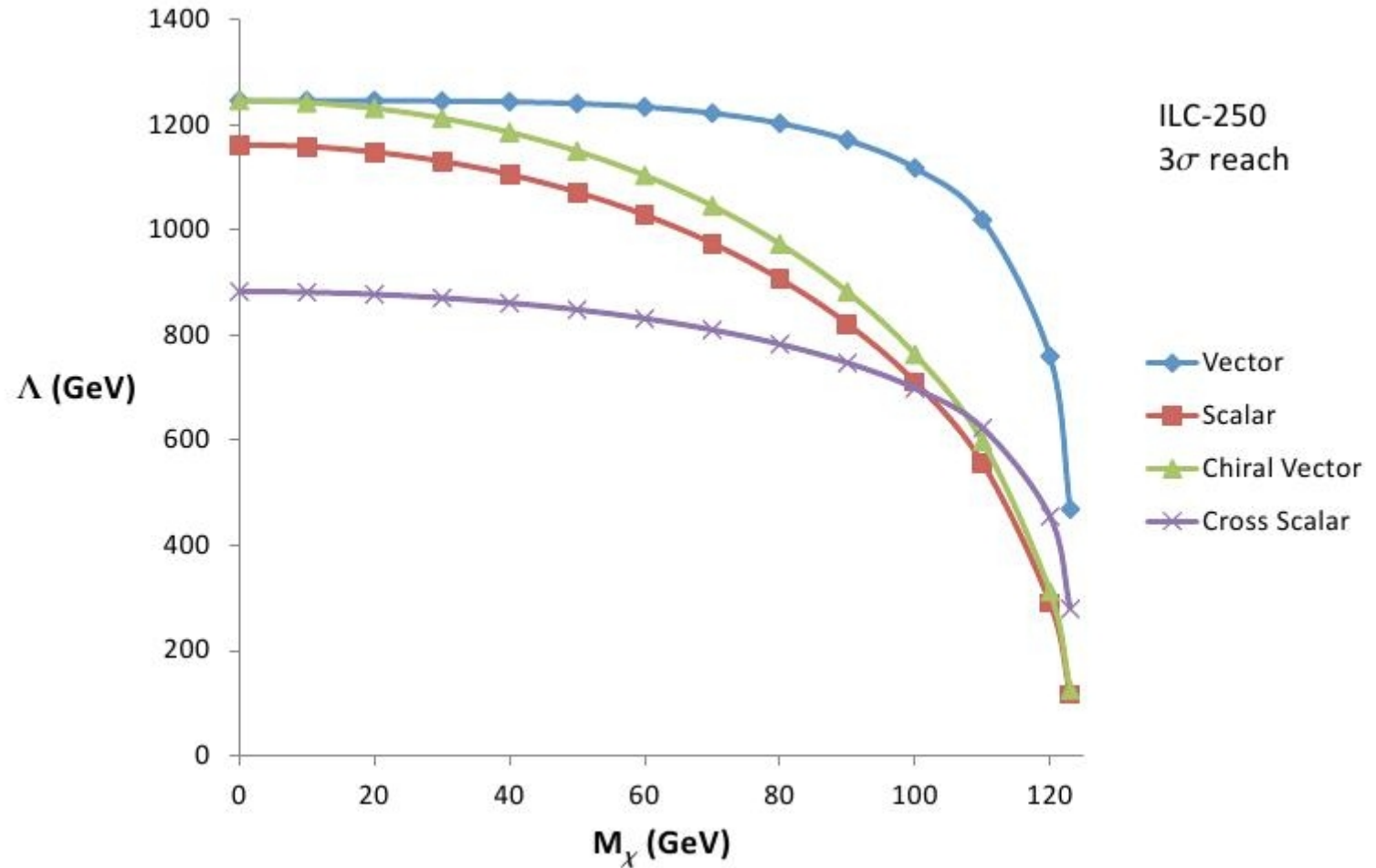

Dark Matter at high energy lepton colliders

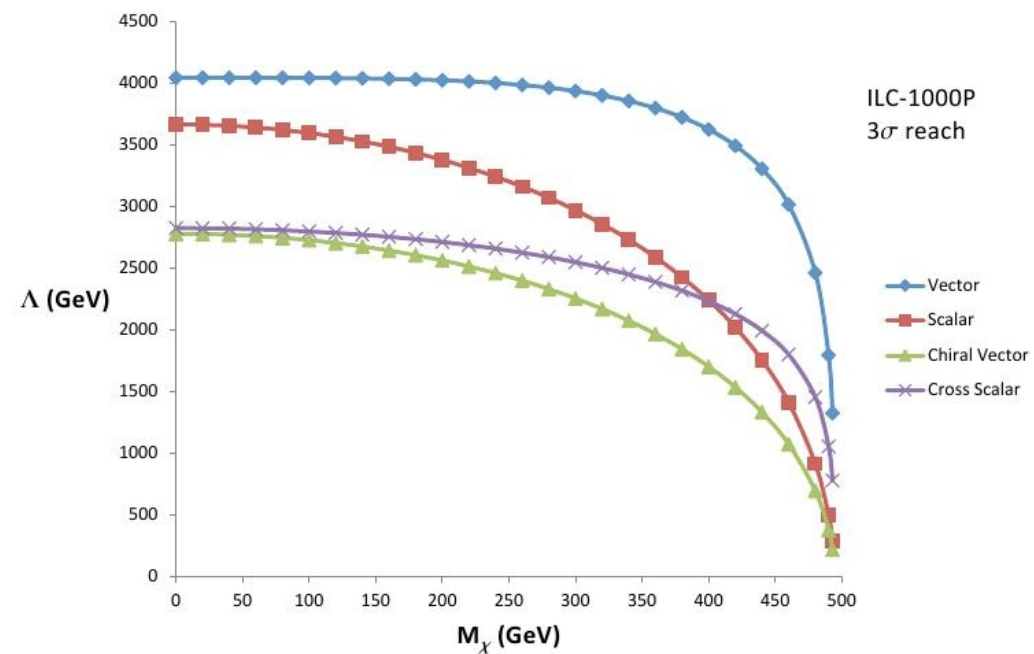
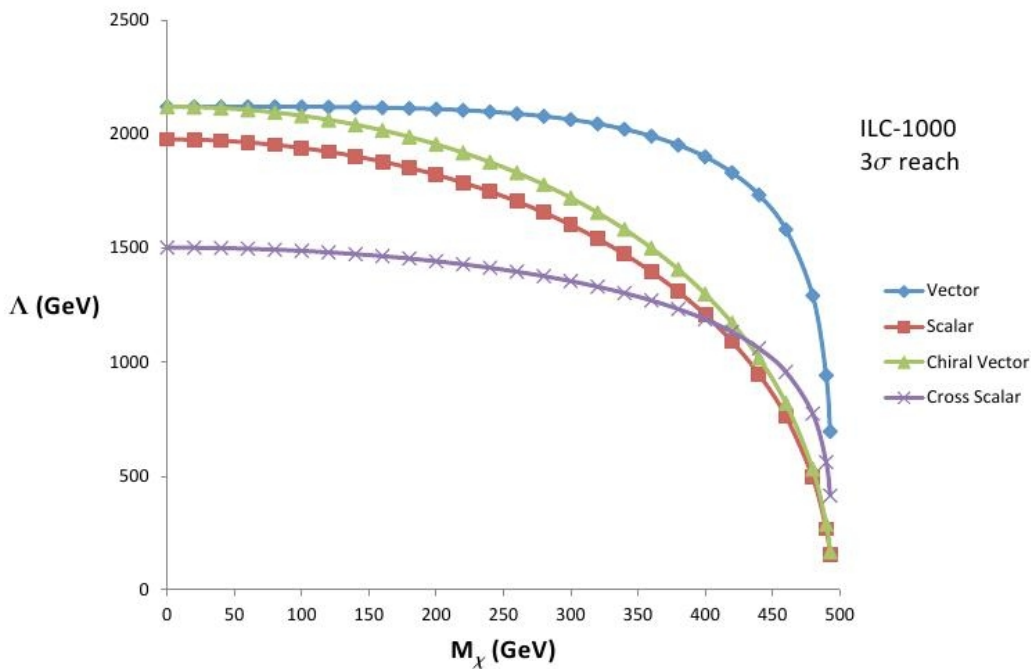
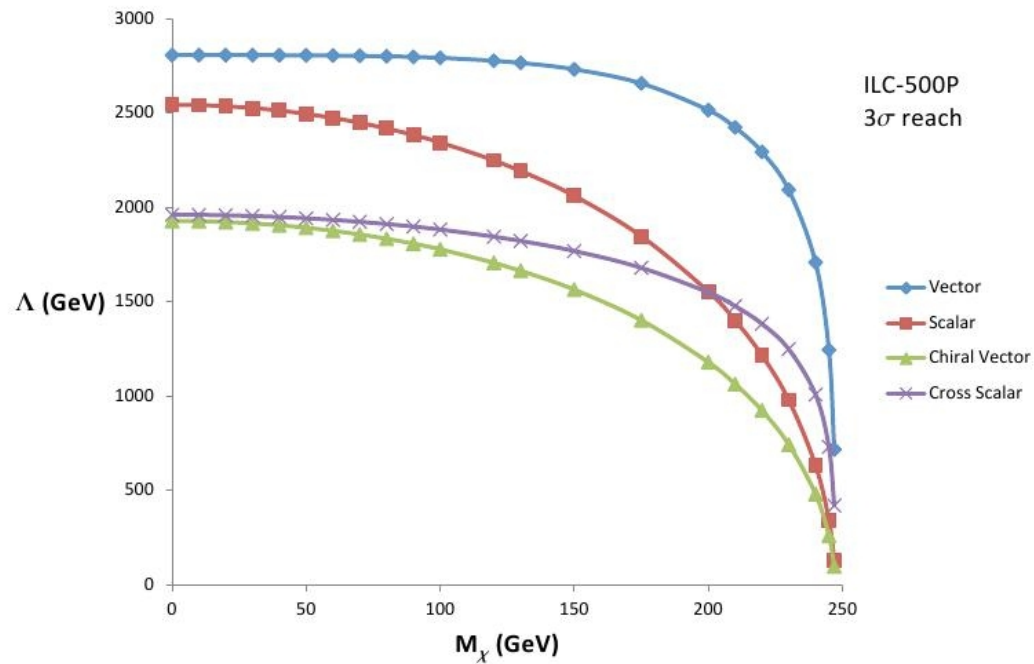
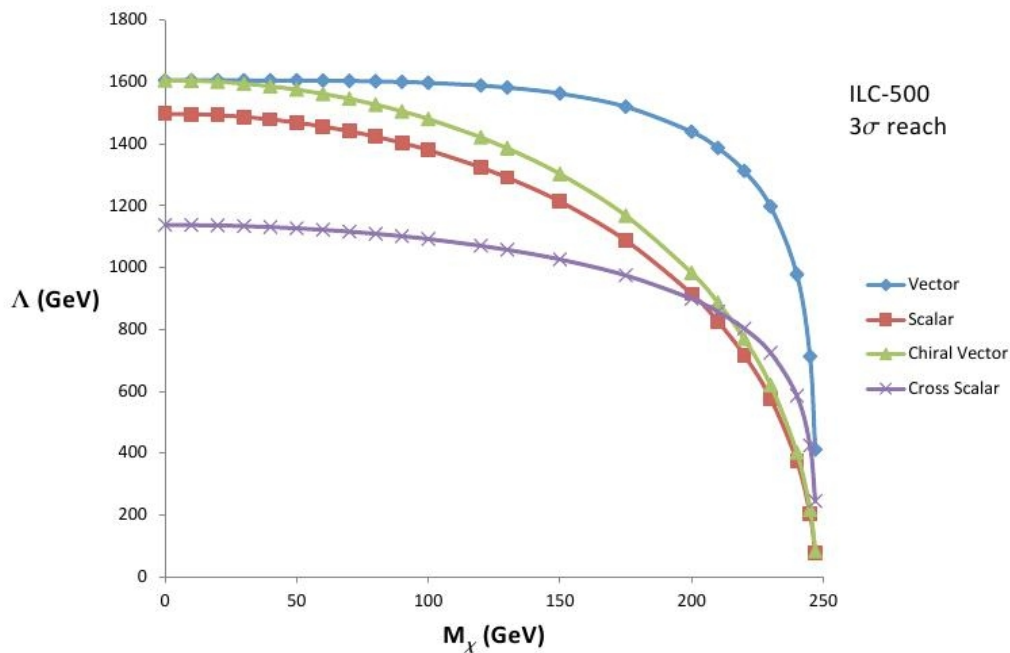

Dark Matter at high energy lepton colliders

VBF type process as DM signal : $e^+ e^- \rightarrow e^+ e^- \chi \chi$

with either scalar or vector mediators
assume DM particle χ is a Dirac fermion

	scalar	vector
e	$i g_{ee\phi,S} \bar{e}e \phi_S$	$i g_{ee\phi,V} \bar{e}\gamma_\mu e \phi_V^\mu$
χ	$i g_{\chi\chi\phi,S} \bar{\chi}\chi \phi_S$	$i g_{\chi\chi\phi,V} \bar{\chi}\gamma_\mu \chi \phi_V^\mu$

different models ($M_* = M_\phi / \sqrt{g_{ee\phi} g_{\chi\chi\phi}}$)

model	mediator mass	mediator spin	WIMP mass	M_*
LSL	8 GeV	0 (scalar)	5 GeV	30 GeV
LVL	8 GeV	1 (vector)	5 GeV	30 GeV
LSH	8 GeV	0 (scalar)	120 GeV	27.4 GeV
LVH	8 GeV	1 (vector)	120 GeV	21 GeV
HSL	200 GeV	0 (scalar)	5 GeV	1250 GeV
HVL	200 GeV	1 (vector)	5 GeV	1250 GeV
HSH	200 GeV	0 (scalar)	120 GeV	332.4 GeV
HVH	200 GeV	1 (vector)	120 GeV	511.8 GeV

model	σ_{unpol}	σ_{++}	σ_{+-}
SM	115.8	49.1	36.4
LSL	1.60	1.79	1.40
LVL	15.07	12.80	17.02
LSH	1.45	1.80	1.10
LVH	9.99	7.64	12.33
HSL	1.17	1.43	0.92
HVL	0.85	0.71	0.89
HSH	1.18	1.45	0.90
HVH	0.85	0.64	0.98

cross sections in femtobarns
with + and - for e^- and e^+
polarization i.e. 80% and 30 %

use MET, $m_{e^+e^-}$, $\phi_{e^+e^-}$, $y_{e^+e^-}$, p_T of hardest lepton and M_{miss} to discriminate DM signal

$M_{\text{miss}} \rightarrow$ provide handle on mass scales

$m_{e^+e^-} \rightarrow$ provide handle on mediator spin

Dark Matter at high energy lepton colliders

level of discrimination of different models for different observables
assuming here realization of LSL (for example)

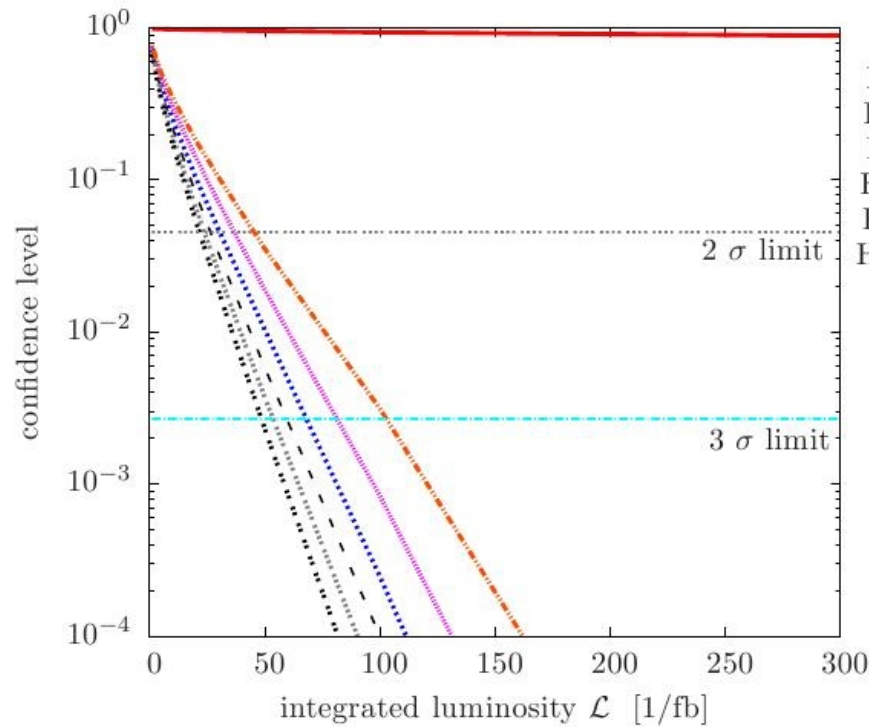

M_{miss}

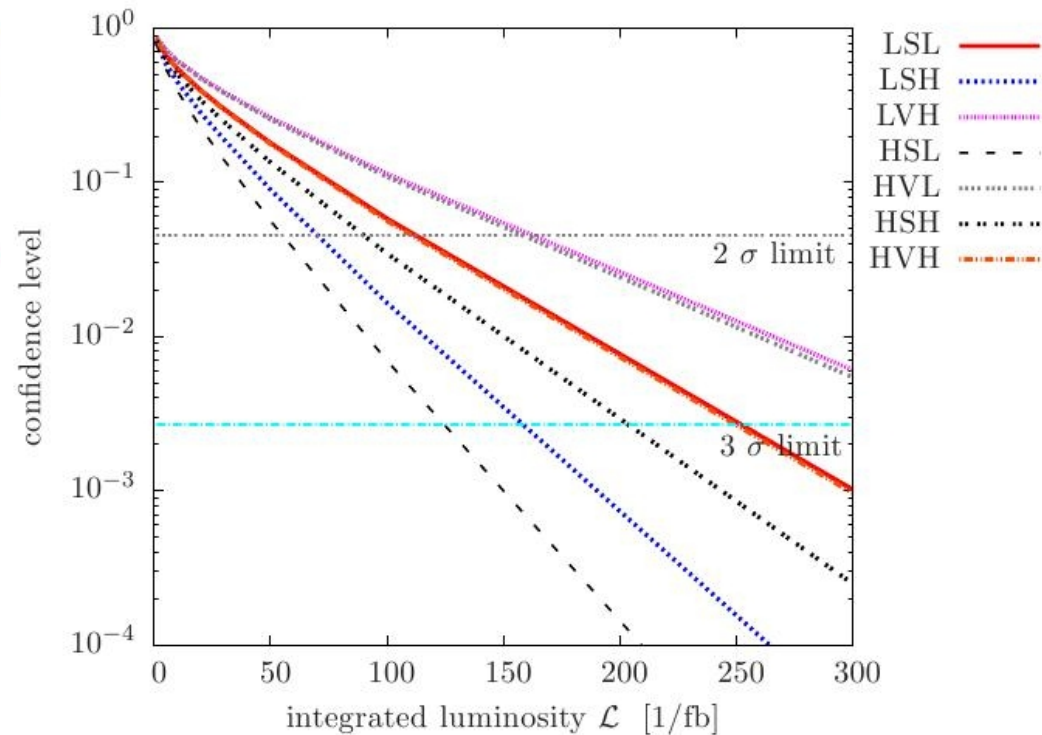

$m_{e^+e^-}$

assuming cross sections to be 2.5 % of the SM background cross section

Wrapping up

DM should be (and is ?) searched for in all possible directions

(colliders **and** non colliders, specific **and** model independent)

- don't give up (yet) on neutralino as a specific DM candidate
 - CMSSM (surprisingly) still alive but anyway far from being the end of the story for SUSY providing viable (neutralino or else) DM candidates (pMSSM and beyond)
- studies of possible Higgs boson decay into invisible particles at ILC (or exotic decays) are not only one extremely important topic per-se but are also very important for DM searches
- specific candidates from extra-dimensions span a large mass spectrum depend on approaches → direct production seems difficult at ILC for heavy DM (e.g. KK photon, KK neutrino)
- recent new approaches such as EFT and ADM only start to be studied for ILC

A large spectrum of activities is ahead of us

not discussed here but would be worth a look:

gravitinos DM, Y. Mambrini et al. → “KKLT” candidate , and /or C. Boehm, P. Fayet → U boson , etc ...

BACKUP SLIDES

Dark Matter

total matter content ρ_M of the energy density in the universe is believed to be

$$\Omega_M \equiv \frac{\rho_M}{\rho_c} \sim 0.3$$

where $\rho_c = 3 H_0^2 m_p^2 \approx 10^{26} \text{ kg/m}^3$ is the critical density, and for baryonic matter :

$$\Omega_B \equiv \frac{\rho_B}{\rho_c} \leq 0.02$$

a lot is missing : under the form of nonbaryonic matter or of a more exotic component

→ dark matter (DM)

from WMAP : $\Omega_{CDM} h^2 = 0.110 \pm 0.006$

where $h^2 = 0.73 + 0.04 - 0.03$ is the scaled Hubble constant

Dark Matter

to which extent a particle of mass m_X can provide the right amount of dark matter ?

suppose this particle is neutral and colorless :

otherwise it would have observable effects through scattering on matter

2 competing effects to modify the abundance of this species:

annihilation

expansion of the universe

the faster the dilution associated with the expansion the less effective the annihilation

this is summarized in a Boltzmann equation giving the evolution of the particle number

density n_X with time

$$\frac{dn_X}{dt} + 3 H n_X = - \langle \sigma_{ann} v \rangle \left(n_X^2 - n_X^{(eq)2} \right)$$

where $\langle \sigma_{ann} v \rangle$ is the thermal average of the $X \bar{X}$ annihilation cross-section times the relative velocity of the 2 particles annihilating, n_X^{eq} is the equilibrium density and H the Hubble parameter

when the temperature drops below m_X the annihilation rate becomes smaller than the expansion rate and there is freezing of the number of particles in a comoving volume

Constrained SUSY – still alive?

The constrained MSSM (CMSSM)
paradigm is “hardly tenable”

At Open Symposium of the European Strategy Preparatory
Group, Krakow, Poland, 10-12 Sept. 2012

Really?

MSSM lagrangian: a reminder (fields content)

superfields		boson fields	fermion fields	
Matter multiplets				
L E^C	leptons	sleptons $\tilde{L} = (\tilde{\nu}_L, \tilde{e}_L^-)$ $\tilde{E} = \tilde{e}_R^+$	leptons (ν_L, e_L^-) e_L^c	
Q U^C D^C	quarks	squarks $\tilde{Q} = (\tilde{u}_L, \tilde{d}_L)$ $\tilde{U} = \tilde{u}_R^*$ $\tilde{D} = \tilde{d}_R^*$	quarks (u_L, d_L) u_L^c d_L^c	
H_1 H_2	Higgs	Higgs (H_1^0, H_1^-) (H_2^+, H_2^0)	Higgsinos $(\tilde{H}_1^0, \tilde{H}_1^-)_L$ $(\tilde{H}_2^+, \tilde{H}_2^0)_L$	charginos $\tilde{X}_{i=1,2}^\pm$
Gauge multiplets				
G		g	\tilde{g} gluino	
V		W^a	\tilde{W}^a wino	
V'		B	\tilde{B} bino	

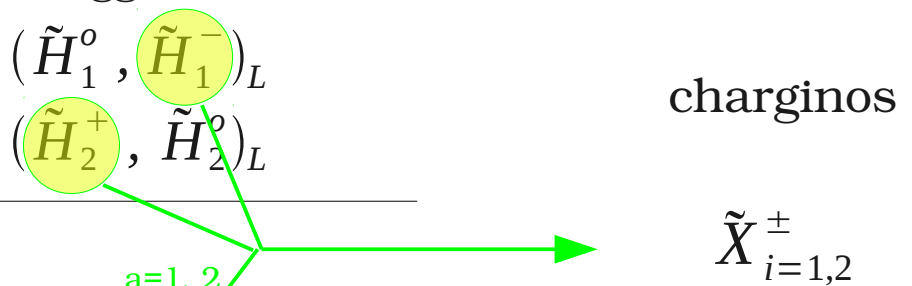

MSSM lagrangian: a reminder (fields content)

superfields		boson fields	fermion fields	
Matter multiplets				
L E^C	leptons	sleptons $\tilde{L} = (\tilde{\nu}_L, \tilde{e}_L^-)$ $\tilde{E} = \tilde{e}_R^+$	leptons (ν_L, e_L^-) e_L^c	
Q U^C D^C	quarks	squarks $\tilde{Q} = (\tilde{u}_L, \tilde{d}_L)$ $\tilde{U} = \tilde{u}_R^*$ $\tilde{D} = \tilde{d}_R^*$	quarks (u_L, d_L) u_L^c d_L^c	
H_1 H_2	Higgs	Higgs (H_1^0, H_1^-) (H_2^+, H_2^0)	Higgsinos $(\tilde{H}_1^0, \tilde{H}_1^-)_L$ $(\tilde{H}_2^+, \tilde{H}_2^0)_L$	neutralinos
<hr/>				
Gauge multiplets				
G V V'		g W^a B	\tilde{g} gluino \tilde{W}^a wino \tilde{B} bino	$\tilde{X}_{i=1,4}^0$

a=1, 2

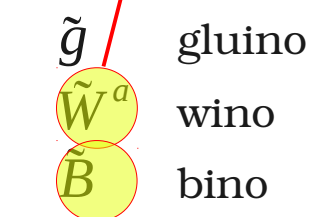

MSSM lagrangian: a reminder

Kinetic terms and gauge interactions (written here without D and F auxiliary fields)

(index i for fermion and sfermion flavours and chirality, index a for vector bosons and gauginos gauge groups)

$$L_{kin} = \boxed{D^\mu \phi^{\dagger i} D_\mu \phi_i + i X^{\dagger i} \bar{\sigma}^\mu D_\mu X_i} - \frac{1}{4} F_{\mu\nu}^a F^{\mu\nu a} + i \lambda^{\dagger a} \bar{\sigma}^\mu D_\mu \lambda^a - \sqrt{2} g \left[(\phi^{\dagger i} T^a X_i) \lambda_a + \lambda_a^\dagger (X^{\dagger i} T^a \phi_i) \right]$$

- kinetic terms for the complex scalar and interactions with the gauge bosons
- kinetic terms for the 2-component fermionic matter fields and interaction with gauge fields

with covariant derivatives

$$D_\mu \phi_i = \partial_\mu \phi_i + i g A_\mu^a (T^a \phi)_i$$

$$D_\mu X_i = \partial_\mu X_i + i g A_\mu^a (T^a X)_i$$

T^a : generators of the gauge group

include trilinear coupling $(A \Psi \Psi)$, $(A \phi \phi)$ and quartic interaction $(A A \phi \phi)$ between scalars and gauge bosons

MSSM lagrangian: a reminder

Kinetic terms and gauge interactions (written here without D and F auxiliary fields)

(index i for fermion and sfermion flavours and chirality, index a for vector bosons and gauginos gauge groups)

$$L_{kin} = D^\mu \phi^{\dagger i} D_\mu \phi_i + i X^{\dagger i} \bar{\sigma}^\mu D_\mu X_i - \frac{1}{4} F_{\mu\nu}^a F^{\mu\nu a} + i \lambda^{\dagger a} \bar{\sigma}^\mu D_\mu \lambda^a - \sqrt{2} g [(\phi^{\dagger i} T^a X_i) \lambda_a + \lambda_a^\dagger (X^{\dagger i} T^a \phi_i)]$$

- contains Yang-Mills field strength

$$F_{\mu\nu}^a = \partial_\mu A_\nu^a - \partial_\nu A_\mu^a - gf^{abc} A_\mu^b A_\nu^c \quad [T^a, T^b] = if^{abc} T^c$$

leading to the kinetic terms of the gauge fields, trilinear interactions (AAA) and quartic interaction of the gauge bosons

- contains kinetic term for the gauginos

with covariant derivative

$$D_\mu \lambda^a = \partial_\mu \lambda^a - gf^{abc} A_\mu^b \lambda^c$$

leading to trilinear interactions of gauginos (A $\lambda\lambda$)

MSSM lagrangian: a reminder

Kinetic terms and gauge interactions (written here without D and F auxiliary fields)

(index **i** for fermion and sfermion flavours and chirality, index **a** for vector bosons and gauginos gauge groups)

$$L_{kin} = D^\mu \phi^{\dagger i} D_\mu \phi_i + i X^{\dagger i} \bar{\sigma}^\mu D_\mu X_i - \frac{1}{4} F_{\mu\nu}^a F^{\mu\nu a} + i \lambda^{\dagger a} \bar{\sigma}^\mu D_\mu \lambda^a - \sqrt{2} g \left[(\phi^{\dagger i} T^a X_i) \lambda_a + \lambda_a^\dagger (X^{\dagger i} T^a \phi_i) \right]$$

- **trilinear interactions** $(\lambda \phi X)$ **between gaugino, scalar and fermion**

MSSM lagrangian: a reminder

potential of the MSSM lagrangian can be derived **from** a function called **superpotential** form constrained by the requirement of invariance under supersymmetry

- polynomial of at most order 3 in the scalar fields with no complex conjugates fields (analytic function of the fields) with a general form (of dimension 3 in mass) :

$$W = \frac{1}{2} M^{ij} \phi_i \phi_j + \frac{1}{6} h^{ijk} \phi_i \phi_j \phi_k \quad \text{determining masses and couplings of matter fields}$$

- in MSSM :

$$W = \epsilon_{ij} (-L^i h_L E^C H_d^j - Q^i h_D D^C H_d^j + Q^i h_U U^C H_u^j + \mu H_u^i H_d^j)$$

$$\epsilon_{ij} = -\epsilon_{ji} \quad (\epsilon_{12} = 1) \quad \text{i,j isospin indices}$$

→ h_L, h_D, h_U are dimensionless Yukawa coupling constants expressed as 3x3 matrices in family space

→ μ Higgs mixing parameter
the only parameter with dimension (mass) in the superpotential

MSSM lagrangian: a reminder

- contribution to the lagrangian for chiral fermions

$$L_{chir} = -\frac{1}{2} \frac{\partial^2 W}{\partial \phi_i \partial \phi_j} X_i X_j + h.c.$$

generates Yukawa interactions and fermion mass terms \longrightarrow for example :

$$L_{chir,e} = -\frac{h_e}{2} \left[(e_L e_L^c) H_d^0 + (e_L^c \tilde{H}_d^0) \tilde{e}_L + (e_L \tilde{H}_d^0) \tilde{e}_L^c - \right. \\ \left. \left[(\nu_e e_L^c) H_d^- - (e_L^c \tilde{H}_d^-) \tilde{\nu}_e - (\nu_e \tilde{H}_d^-) \tilde{e}_L^c \right] + h.c. \right]$$

contains the trilinear Yukawa interaction between fermions, scalars and Higgs or Higgsinos

1st term is the familiar SM Yukawa interaction generating mass for the fermions after electroweak symmetry breaking, other terms correspond to new interactions

- in addition : contribution from the mu-term in the superpotential

$$\mu (\tilde{H}_u^0 \tilde{H}_d^0 - \tilde{H}_u^+ \tilde{H}_d^-) + c.c.$$

providing off-diagonal elements in the mass matrices for the higgsino fermions
physical states will be mixtures of the higgsino fields

MSSM lagrangian: a reminder

- scalar potential including two contributions :

$$F_i = \frac{\partial W}{\partial \phi_i}$$

chiral contribution or F-terms (from equation of motion of auxiliary fields F)

$$D^a = g \phi_i^\dagger T_{ij}^a \phi_j$$

gauge contribution or D-terms (from equation of motion of auxiliary field D)

$$V(\phi) = F^i F_i^\dagger + \frac{1}{2} D^a D_a \quad \text{scalar potential (in compact form)}$$

Full lagrangian density for an unbroken supersymmetry

$$L = L_{kin} + L_{chir} + V(\phi)$$

MSSM lagrangian: a reminder

previous superpotential is not the most general one

additional terms allowed by gauge invariance (and renormalizability)

$$W_{R_p} = \mu_i H_u L_i + \lambda_{ijk} L_i L_j E_k^C + \lambda'_{ijk} L_i Q_j D_k^C - \lambda''_{ijk} U_i^C U_j^C D_k^C$$

violate Lepton number **L** conservation

violate Baryon number **B** conservation

since B and L
can be carried by boson fields

violations can be avoided by introducing a discrete symmetry known as R-parity

i.e. introducing a multiplicatively conserved number

$$R = (-1)^{3B + L + 2S}$$

$$R_{SM} = +1$$

$$R_{SUSY} = -1$$

Field	B	L	S	$3B + L + 2S$
quark	1/3	0	1/2	2
squark	1/3	0	0	1
lepton	0	1	1/2	2
slepton	0	1	0	1

Supersymmetry with R-parity violation together with the phenomenology from the above R-parity violating potential will be addressed in a dedicated lecture

MSSM lagrangian: a reminder

- in unbroken supersymmetry (SUSY) superpartners are expected to be degenerate in mass with the SM particles of the same supermultiplet and massless

Non observation of superpartners requires SUSY to be broken

to avoid quadratic divergences in the radiative corrections of scalar particles masses (i.e. avoid the “return” of the hierarchy problem of the SM)

SUSY breaking must take a specific form i.e. **soft supersymmetry breaking**

➔ **most general terms to be added to the lagrangian**

$$L_{soft} = \sum_{\tilde{q}, \tilde{l}, H_{u,d}} m_{o,i}^2 |\phi_i|^2 - \frac{1}{2} m_{1/2,a} \lambda_a \lambda_a - A_{0,i} W_{3,i} - B \mu H_u H_d$$

the parameters of soft SUSY breaking have positive mass dimension

$m_{o,i}$ mass parameter of the scalar (in principle a matrix in generation space)

$m_{1/2,a}$ mass parameter the gauginos

$A_{0,i}, B$ parameter of dimension of mass (A is called trilinear coupling)

$W_{3,i}$ trilinear terms of the superpotential

Gauginos: reminder

mixing between neutral gaugino and neutral component of higgsinos

occurs after $SU(2)_L \times U(1)_Y$ breaking giving thus rise to neutralinos $\tilde{\chi}^0$

in the basis $\tilde{\chi}^0 = (\tilde{B}, \tilde{W}_3, \tilde{H}_d^0, \tilde{H}_u^0)$ the mass matrix takes the form

$$Y = \begin{pmatrix} M_1 & 0 & -M_Z \cos \beta \sin \theta_W & M_Z \sin \beta \sin \theta_W \\ 0 & M_2 & M_Z \cos \beta \cos \theta_W & -M_Z \sin \beta \cos \theta_W \\ -M_Z \cos \beta \sin \theta_W & M_Z \cos \beta \cos \theta_W & 0 & -\mu \\ M_Z \sin \beta \sin \theta_W & -M_Z \sin \beta \cos \theta_W & -\mu & 0 \end{pmatrix}$$

- 2x2 block with parameters M_1 and M_2 from soft SUSY breaking terms $M_a \lambda \lambda$

- 2x2 block depending on μ from the MSSM lagrangian

- off diagonal terms proportional to M_2 coming from the $\lambda H \tilde{H}$ couplings

Gauginos: reminder

the parameters M_1, M_2, μ in this mass matrix can have arbitrary phase

a redefinition of the phase of \tilde{B}, \tilde{W}_3^0 allows to make both M_1, M_2 real and positive

the symmetric neutralino mass matrix can be diagonalized $Y_{diag} = N^* Y N^\dagger$ by a single unitary matrix N transforming the interaction eigenstates to the mass eigenstates basis of majorana fields $\tilde{\chi}_i^0$

$$\tilde{\chi}_i^0 = N_{i,1} \tilde{B} + N_{i,2} \tilde{W}_3 + N_{i,3} \tilde{H}_d^0 + N_{i,4} \tilde{H}_u^0$$

the squared mass matrix $Y_{diag} Y_{diag}^\dagger = N^* Y Y^\dagger N^T$ is real and positive definite

Y_{diag} can be chosen positive by a suitable definition of the unitary matrix N

the mass matrix can be diagonalized analytically but the resulting formulae are lengthy and not particularly illuminating

eigenvectors and eigenvalues are usually calculated numerically

in MSSM

Neutralinos (i.e. Majorana fermions in MSSM - see later on for Dirac gauginos)

$$\tilde{\chi}_i^o = N_{i,1} \tilde{B} + N_{i,2} \tilde{W}_3 + N_{i,3} \tilde{H}_d^o + N_{i,4} \tilde{H}_u^o$$

writing down the interactions of the neutralino with the Z boson :

$$L_{\tilde{\chi}_1^o \tilde{\chi}_1^o Z} = -\frac{1}{4} \frac{g}{\cos \theta_W} \left(|N_{13}|^2 - |N_{14}|^2 \right) \bar{\tilde{\chi}}_1^o \gamma^\mu \gamma^5 \tilde{\chi}_1^o Z_\mu$$

$$L_{\tilde{\chi}_1^o \tilde{\chi}_m^o Z} = -\frac{1}{4} \frac{g}{\cos \theta_W} Z_\mu \left[\bar{\tilde{\chi}}_1^o \gamma^\mu L \tilde{\chi}_m^o \left(N_{13} N_{m3}^* - N_{14} N_{m4}^* \right) - \bar{\tilde{\chi}}_1^o \gamma^\mu R \tilde{\chi}_m^o \left(N_{13}^* N_{m3} - N_{14}^* N_{m4} \right) \right]$$

In MSSM

the coupling to the neutral Higgs system can be summarized as :

$$L_{\tilde{\chi}_1^o \tilde{\chi}_1^o H} = \frac{g}{2} (N_{12} - \tan \theta_w N_{11}) \left[(\cos \alpha N_{13} - \sin \alpha N_{14}) H - (\sin \alpha N_{13} + \cos \alpha N_{14}) h \right. \\ \left. + i (\sin \beta N_{13} - \cos \beta N_{14}) A \right] \tilde{\chi}_1^o R \tilde{\chi}_1^o + h.c$$

we see that such couplings vanish when the lightest neutralino is purely gaugino

$$N_{13} = N_{14} = 0 \quad \text{or purely higgsino} \quad N_{11} = N_{12} = 0$$

the coupling to quarks and squarks are given by :

$$L_{\tilde{\chi}_1^o q \tilde{q}} = - \bar{q}_{iL} \tilde{\chi}_1^o \left(X_i \tilde{q}_{iL} + Z_i^q \tilde{q}_{iR} \right) - \bar{q}_{iR} \tilde{\chi}_1^o \left(Y_i^* \tilde{q}_{iR} + Z_i^q \tilde{q}_{iL} \right)$$

where (i=1,2,3 being a family index) :

$$X_i = -g \sqrt{2} \left[t_i^3 N_{12} + \frac{y_i}{2} \tan \theta_w N_{11} \right] \qquad Z_i^u = -\frac{g}{\sqrt{2}} \frac{m_{ui}}{M_w} \frac{N_{14}^*}{\sin \theta_w}$$

$$Y_i = -g \sqrt{2} q_i N_{11} \tan \theta_w \qquad Z_i^d = -\frac{g}{\sqrt{2}} \frac{m_{ui}}{M_w} \frac{N_{13}^*}{\cos \theta_w}$$

In MSSM

the coupling to the charginos and W reads :

$$L_{\tilde{\chi}_1^0 \tilde{\chi}_r^\pm W^\mp} = -g \tilde{\chi}_1^0 \gamma^\mu \left[\left(N_{12} Z_{Lr1}^* - \frac{1}{\sqrt{2}} N_{14} Z_{Lr2}^* \right) L + \left(N_{12}^* Z_{Rr1}^* + \frac{1}{\sqrt{2}} N_{13}^* Z_{Rr2}^* \right) R \right] \tilde{\chi}_r^\pm W_\mu^\mp + h.c.$$

where the Z matrices are defined by :

$$\begin{pmatrix} \tilde{\chi}_{1L}^+ \\ \tilde{\chi}_{2L}^+ \end{pmatrix} = Z_L \begin{pmatrix} \tilde{W}_L^+ \\ \tilde{H}_u^+ \end{pmatrix} \quad \begin{pmatrix} \tilde{\chi}_{1R}^+ \\ \tilde{\chi}_{2R}^+ \end{pmatrix} = Z_L \begin{pmatrix} \tilde{W}_R^+ \\ \tilde{H}_d^{-c} \end{pmatrix} \quad Z_R M_C Z_L^* = \begin{pmatrix} m_{\tilde{\chi}_1^\pm} & 0 \\ 0 & m_{\tilde{\chi}_2^\pm} \end{pmatrix}$$

such that $L_C = -m_{\tilde{\chi}_1^\pm} \tilde{\chi}_{1R}^+ \tilde{\chi}_{1L}^- - m_{\tilde{\chi}_2^\pm} \tilde{\chi}_{2R}^+ \tilde{\chi}_{2L}^-$ and one also has :

$$Z_{L,R} = \begin{pmatrix} \cos \Phi_{L,R} & \sin \Phi_{L,R} \\ -\sin \Phi_{L,R} & \cos \Phi_{L,R} \end{pmatrix}$$

$$\tan 2\Phi_L = 2 M_W \sqrt{2} \frac{\mu \cos \beta + M_2 \sin \beta}{\mu^2 - M_2^2 - 2 M_W^2 \cos 2\beta}$$

$$\tan 2\Phi_R = 2 M_W \sqrt{2} \frac{\mu \sin \beta + M_2 \cos \beta}{\mu^2 - M_2^2 + 2 M_W^2 \cos 2\beta}$$

3rd generation squarks

for stop and sbottom squarks the squared mass matrix take then the form

$$M_{\tilde{q}}^2 = \begin{pmatrix} m_{\tilde{q}_L}^2 & a_q m_q \\ a_q m_q & m_{\tilde{q}_R}^2 \end{pmatrix} = (R^{\tilde{q}})^\dagger \begin{pmatrix} m_{\tilde{q}_1}^2 & 0 \\ 0 & m_{\tilde{q}_2}^2 \end{pmatrix} R^{\tilde{q}}$$

with

$$m_{\tilde{q}_L}^2 = M_{\tilde{Q}}^2 + M_Z^2 \cos 2\beta \left(I_{3L}^q - Q_q \sin^2 \theta_W \right) + m_q^2$$

$$m_{\tilde{q}_R}^2 = M_{[\tilde{U}, \tilde{D}]}^2 + Q_q M_Z^2 \cos 2\beta \sin^2 \theta_W + m_q^2$$

$$a_q = A_q - \mu \{ \cot \beta, \tan \beta \}$$

for { up, down } type squarks respectively

$M_{\tilde{Q}}, M_{\tilde{U}}, M_{\tilde{D}}$ are soft Susy breaking masses and A_q are trilinear couplings

3rd generation squarks

stops are expected to be highly mixed due to the large top quark mass
sbottoms are also expected to be mixed if $\tan \beta$ is large

weak eigenstates \tilde{q}_L, \tilde{q}_R are related to mass eigenstates \tilde{q}_1, \tilde{q}_2 by :

$$\begin{pmatrix} \tilde{q}_1 \\ \tilde{q}_2 \end{pmatrix} = R^{\tilde{q}} \begin{pmatrix} \tilde{q}_L \\ \tilde{q}_R \end{pmatrix} \quad \text{with} \quad R^{\tilde{q}} = \begin{pmatrix} \cos \theta_{\tilde{q}} & \sin \theta_{\tilde{q}} \\ -\sin \theta_{\tilde{q}} & \cos \theta_{\tilde{q}} \end{pmatrix}$$

the mass eigenvalues are :

$$m_{\tilde{q}_{1,2}}^2 = \frac{1}{2} \left(m_{\tilde{q}_L}^2 + m_{\tilde{q}_R}^2 \mp \sqrt{\left(m_{\tilde{q}_L}^2 - m_{\tilde{q}_R}^2 \right)^2 + 4 a_q^2 m_q^2} \right)$$

and the mixing angles :

$$\cos \theta_{\tilde{q}} = \frac{-a_q m_q}{\sqrt{\left(m_{\tilde{q}_L}^2 - m_{\tilde{q}_1}^2 \right)^2 + 4 a_q^2 m_q^2}} \quad \sin \theta_{\tilde{q}} = \frac{m_{\tilde{q}_L}^2 - m_{\tilde{q}_1}^2}{\sqrt{\left(m_{\tilde{q}_L}^2 - m_{\tilde{q}_1}^2 \right)^2 + 4 a_q^2 m_q^2}}$$

3rd generation slepton

the mass matrix of the charged slepton is completely analogous to that of squarks

$$M_{\tilde{l}}^2 = \begin{pmatrix} m_{\tilde{l}_L}^2 & a_l m_l \\ a_l m_l & m_{\tilde{l}_R}^2 \end{pmatrix}$$

with

$$m_{\tilde{l}_L}^2 = M_{\tilde{L}}^2 - M_Z^2 \cos 2\beta \left(\frac{1}{2} - \sin^2 \theta_W \right) + m_l^2$$

$$m_{\tilde{l}_R}^2 = M_{\tilde{E}}^2 - M_Z^2 \cos 2\beta \sin^2 \theta_W + m_l^2$$

$$a_l = A_l - \mu \tan \beta$$

from RG evolution one expects $M_{\tilde{E}}^2 < M_{\tilde{L}}^2$ and hence $m_{\tilde{l}_R} < m_{\tilde{l}_L}$

3rd generation slepton

for selectrons and smuons the “left” and “right” states $\tilde{e}_{L,R}$, $\tilde{\mu}_{L,R}$ are also the mass eigenstates

for staus however analogous arguments apply as for sbottom

if $\tan \beta$ is large enough $\tilde{\tau}_L$ and $\tilde{\tau}_R$ will mix to mass eigenstates

$$\begin{pmatrix} \tilde{\tau}_1 \\ \tilde{\tau}_2 \end{pmatrix} = R^{\tilde{\tau}} \begin{pmatrix} \tilde{\tau}_L \\ \tilde{\tau}_R \end{pmatrix} \quad R^{\tilde{\tau}} = \begin{pmatrix} \cos \theta_{\tilde{\tau}} & \sin \theta_{\tilde{\tau}} \\ -\sin \theta_{\tilde{\tau}} & \cos \theta_{\tilde{\tau}} \end{pmatrix}$$

$$m_{\tilde{\tau}_{1,2}}^2 = \frac{1}{2} \left(m_{\tilde{\tau}_L}^2 + m_{\tilde{\tau}_R}^2 \mp \sqrt{\left(m_{\tilde{\tau}_L}^2 - m_{\tilde{\tau}_R}^2 \right)^2 + 4a_\tau^2 m_\tau^2} \right)$$

$$\cos \theta_{\tilde{\tau}} = \frac{-a_\tau m_\tau}{\sqrt{\left(m_{\tilde{\tau}_L}^2 - m_{\tilde{\tau}_1}^2 \right)^2 + 4a_\tau^2 m_\tau^2}} \quad \sin \theta_{\tilde{\tau}} = \frac{m_{\tilde{\tau}_L}^2 - m_{\tilde{\tau}_1}^2}{\sqrt{\left(m_{\tilde{\tau}_L}^2 - m_{\tilde{\tau}_1}^2 \right)^2 + 4a_\tau^2 m_\tau^2}}$$

Mass constraints on lightest Neutralino

Table 25. Summary of mass limits for supersymmetric particles and their validity conditions. In each line of the table ΔM is the mass difference between the corresponding sparticle and the LSP. All masses and ΔM values are in GeV/c^2 . CMSSM refers to a model with gauge and sfermion mass unification, where μ however is a free parameter (see Sect. 2). Neutralino mass limits should be lowered by $1 \text{ GeV}/c^2$ if the radiative corrections of [51] are taken into account

Particle	Validity conditions	Mass limit (GeV/c^2)
\tilde{e}_R	$\tan\beta=1.5, \mu=-200, \Delta M>15$	94
	CMSSM, $\Delta M>10$	94
$\tilde{\mu}_R$	$\text{BR}(\tilde{\mu} \rightarrow \mu \tilde{\chi}^0)=1, \Delta M>5$	88
	CMSSM, $\Delta M>10$	94
$\tilde{\tau}$	$\text{BR}(\tilde{\tau} \rightarrow \tau \tilde{\chi}^0)=1, \Delta M \geq m_\tau$	26
$\tilde{\tau}_R$	$\text{BR}(\tilde{\tau} \rightarrow \tau \tilde{\chi}^0)=1, \Delta M>15, \text{ no mixing}$	85
$\tilde{\tau}_{min}$	$\text{BR}(\tilde{\tau} \rightarrow \tau \tilde{\chi}^0)=1, \Delta M>15, \text{ minimal cross-section}$	82
$\tilde{\nu}$	CMSSM, $(M_{\tilde{e}_R} - M_{\tilde{\chi}^0})>10$	94
\tilde{b}	$\text{BR}(\tilde{b} \rightarrow b \tilde{\chi}^0)=1, \Delta M>7, \text{ no mixing}$	93
	$\text{BR}(\tilde{b} \rightarrow b \tilde{\chi}^0)=1, \Delta M>7, \text{ minimal cross-section}$	76
\tilde{t}	$\text{BR}(\tilde{t} \rightarrow c \tilde{\chi}^0)=1, \Delta M>10, \text{ no mixing}$	96
	$\text{BR}(\tilde{t} \rightarrow c \tilde{\chi}^0)=1, \Delta M>2, \text{ no mixing}$	75
	$\text{BR}(\tilde{t} \rightarrow c \tilde{\chi}^0)=1, \Delta M>10, \text{ minimal cross-section}$	92
	$\text{BR}(\tilde{t} \rightarrow c \tilde{\chi}^0)=1, \Delta M>2, \text{ minimal cross-section}$	71
$\tilde{\chi}^\pm$	$m_{\tilde{\nu}}>1000, \Delta M>10, M_1 \approx 0.5 M_2,$	102.7
	$M_{\tilde{f}} > M_{\tilde{\chi}^\pm}, \Delta M>3$	97
	$M_{\tilde{f}} > M_{\tilde{\chi}^\pm}, \text{ any } \Delta M, M_1 \approx 0.5 M_2$	75
	$m_{\tilde{\nu}}>300, \mu \geq M_2, \text{ no gaugino mass unification, any } \Delta M$	70
	CMSSM, $\Delta M>3, \text{ any } m_0, \text{ no mixing or } \Delta M(\tilde{\tau}-\tilde{\chi}^0)>6$	94
CMSSM, any $m_0, \text{ any } M_2, \tan\beta < 40, \text{ mixing } A_\tau=A_b=A_t=0$	90	
$\tilde{\chi}^0$	CMSSM, high $m_0, \tan\beta > 1, \text{ maximal mixing in } \tilde{t} \text{ sector}$	49
	CMSSM, any $m_0, \tan\beta < 40 \text{ no mixing or } \Delta M(\tilde{\tau}-\tilde{\chi}^0)>6$	46
	CMSSM, any $m_0, \tan\beta < 40, \text{ mixing } A_\tau=A_b=A_t=0$	46
	CMSSM, any $m_0, 1 < \tan\beta < 40, \text{ mix. } A_\tau=A_b=0, A_t = \sqrt{6} \text{ TeV}/c^2$	49

$m_{\tilde{\chi}_1^0}$ also includes searches for pair produced 'higher' neutralinos in multi-lepton, multi-jets (with and without γ) channels

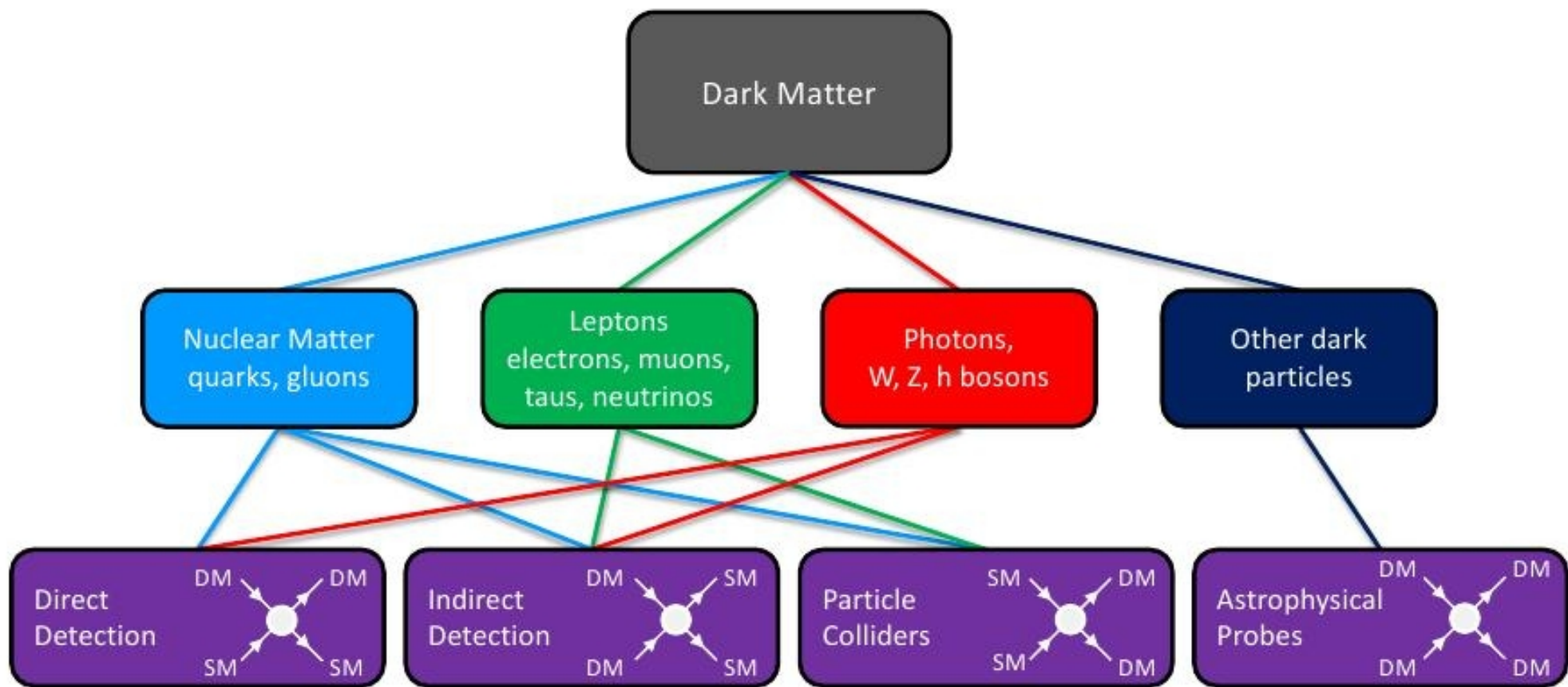

dark matter particle may have non-gravitational interactions with one or more of 4 categories of particles

these interactions may then be probed by 4 complementary approaches

Some Dark Matter candidates

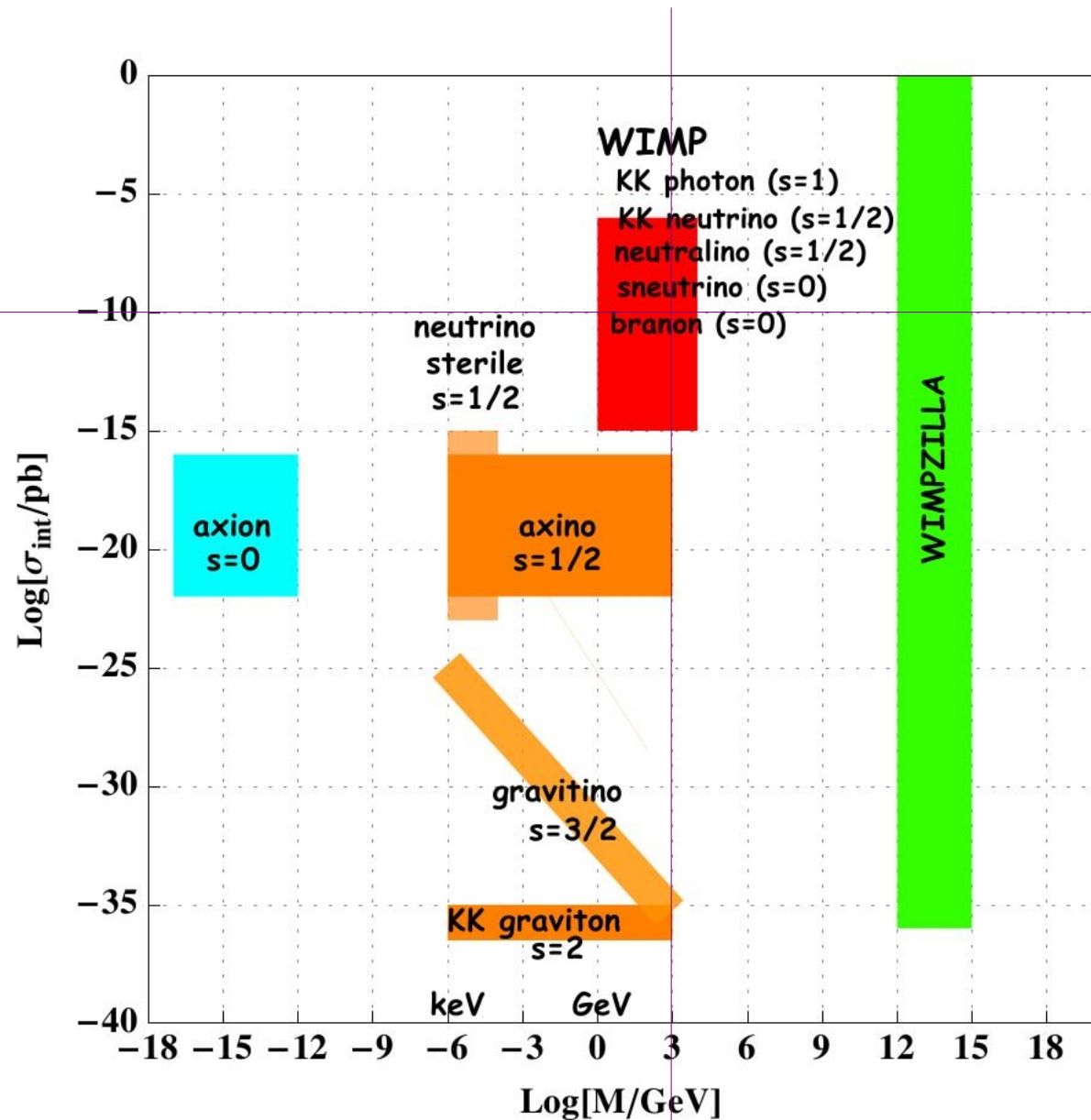

not yet explored
(below Xenon 100 limit)

below 1 TeV (out of reach for ILC)

Some Dark Matter candidates

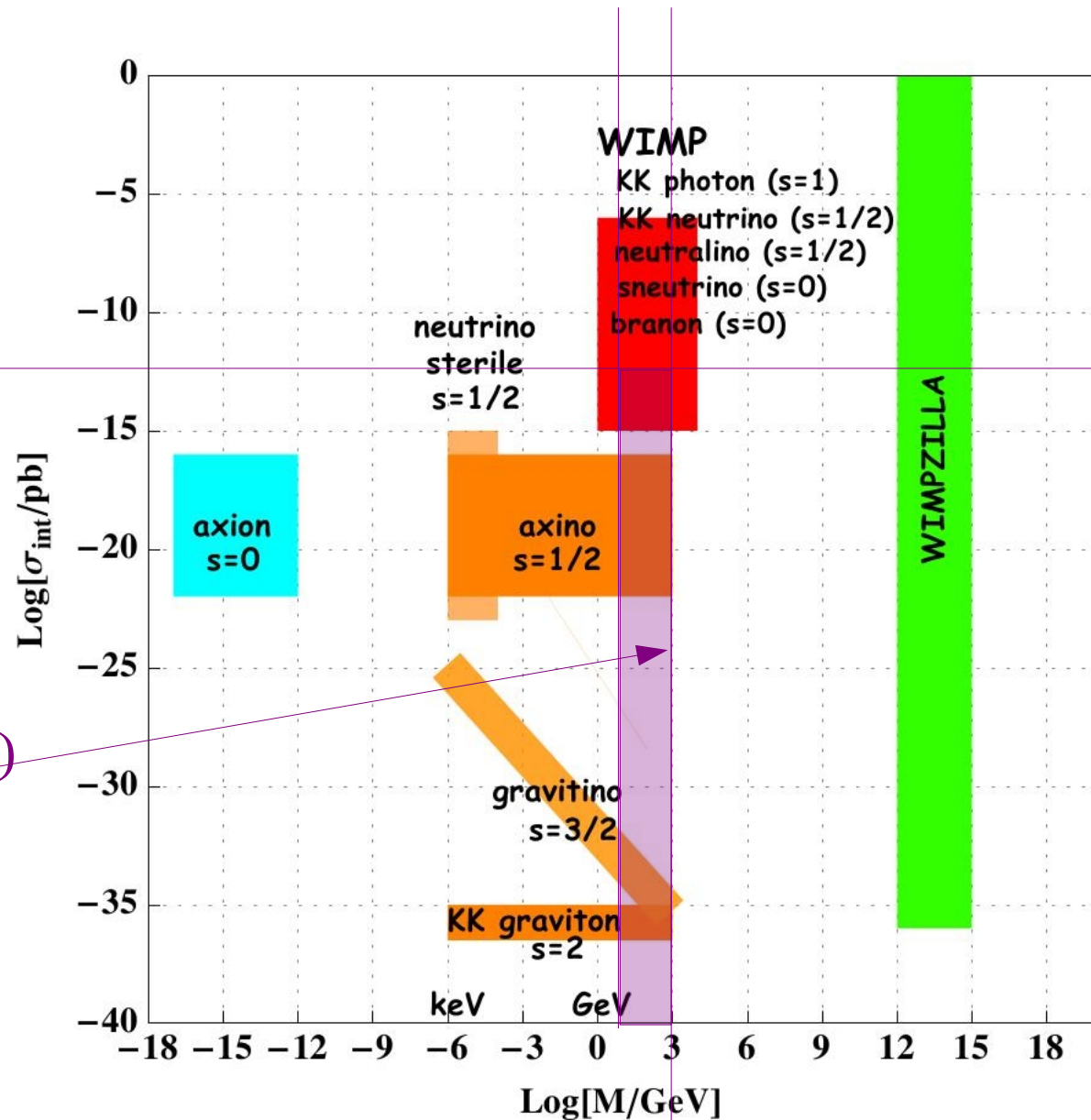

less than 1 event
per ton per year (XENON)

below 1 TeV (out of reach for ILC)

Some Dark Matter candidates

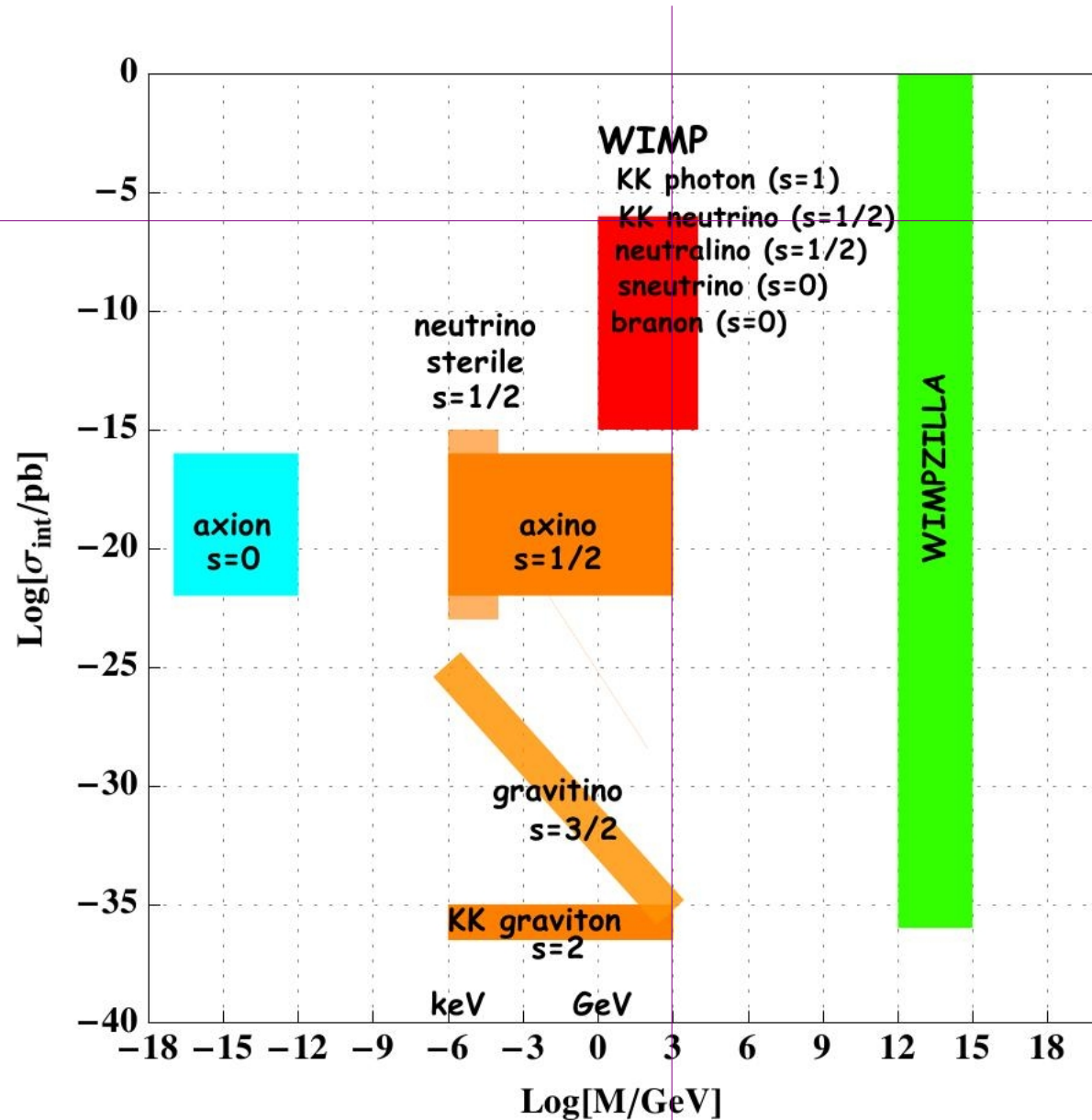

not yet explored
(below LHC with EFT)
(how low in mass?)

below 1 TeV (out of reach for ILC)

Dark Matter

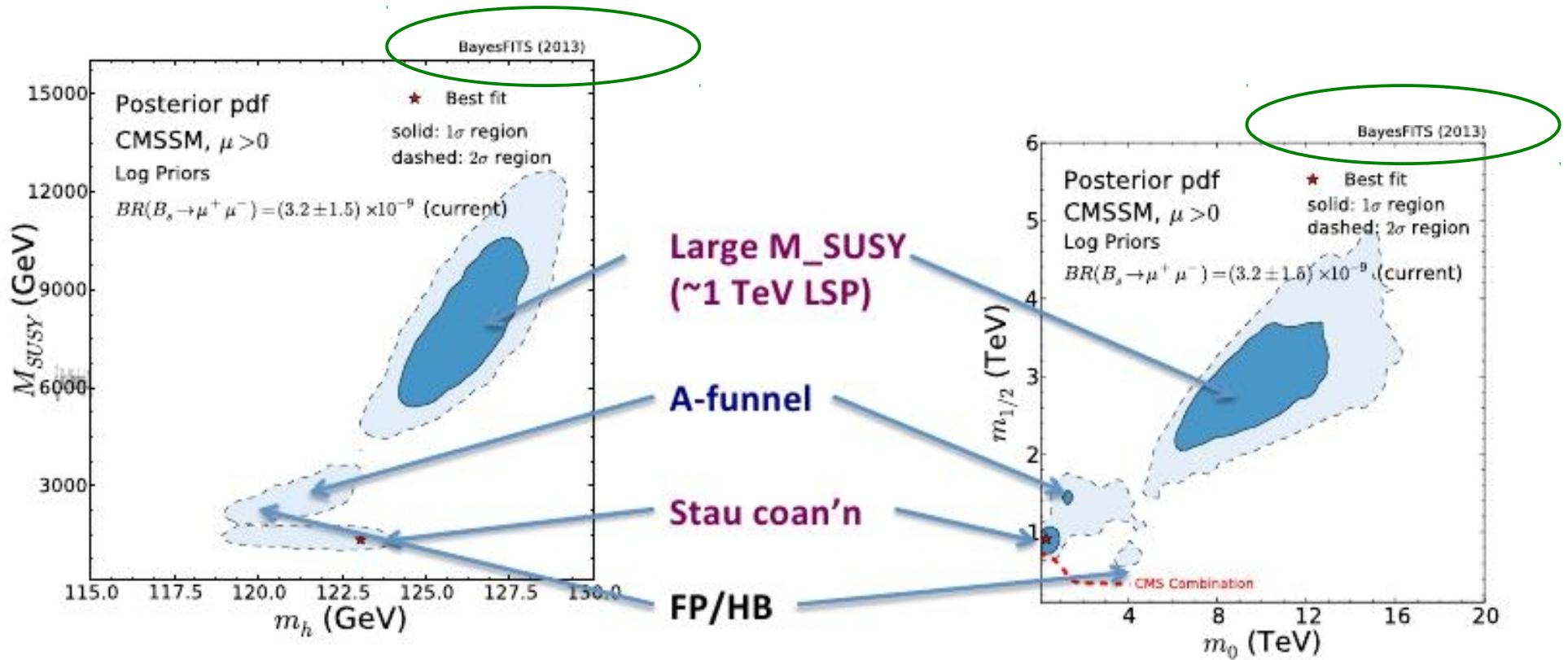

Dark Matter : beyond CMSSM \rightarrow pMSSM

example 2 : 'phenomenological MSSM' pMSSM

Parameter	Description	Prior Range
$\tan \beta$	Ratio of the scalar doublet vevs	[1, 60]
μ	Higgs-Higgsino mass parameter	[-3, 3] TeV
M_A	Pseudo-scalar Higgs mass	[0.3, 3] TeV
M_1	Bino mass	[-0.5, 0.5] TeV
M_2	Wino mass	[-1, 1] TeV
M_3	Gluino mass	[0.8, 3] TeV
$m_{\tilde{q}_L}$	First/second generation Q_L squark	[0, 3] TeV
$m_{\tilde{u}_R}$	First/second generation U_R squark	[0, 3] TeV
$m_{\tilde{d}_R}$	First/second generation D_R squark	[0, 3] TeV
$m_{\tilde{\ell}_L}$	First/second generation L_L slepton	[0, 3] TeV
$m_{\tilde{e}_R}$	First/second generation E_R slepton	[0, 3] TeV
$m_{\tilde{Q}_{3L}}$	Third generation Q_L squark	[0, 3] TeV
$m_{\tilde{t}_R}$	Third generation U_R squark	[0, 3] TeV
$m_{\tilde{b}_R}$	Third generation D_R squark	[0, 3] TeV
$m_{\tilde{L}_{3L}}$	Third generation L_L slepton	[0, 3] TeV
$m_{\tilde{\tau}_R}$	Third generation E_R slepton	[0, 3] TeV
A_t	Trilinear coupling for top quark	[-10, 10] TeV
A_b	Trilinear coupling for bottom quark	[-10, 10] TeV
A_τ	Trilinear coupling for τ -lepton	[-10, 10] TeV

Dark Matter : beyond CMSSM \rightarrow pMSSM

WMAP allowed points are circled
 top : without DM density rescaling
 bottom : with DM density rescaling

i.e. in case of multi DM scenario

\rightarrow neutralino DM will only be a fraction of the total observed DM density

\rightarrow one must scale the neutralino DM density

Xsection depends linearly on DM density

\rightarrow use rescaling factor $r_\chi = \Omega_{\tilde{\chi}_1^0} / \Omega_{\text{observed}}$

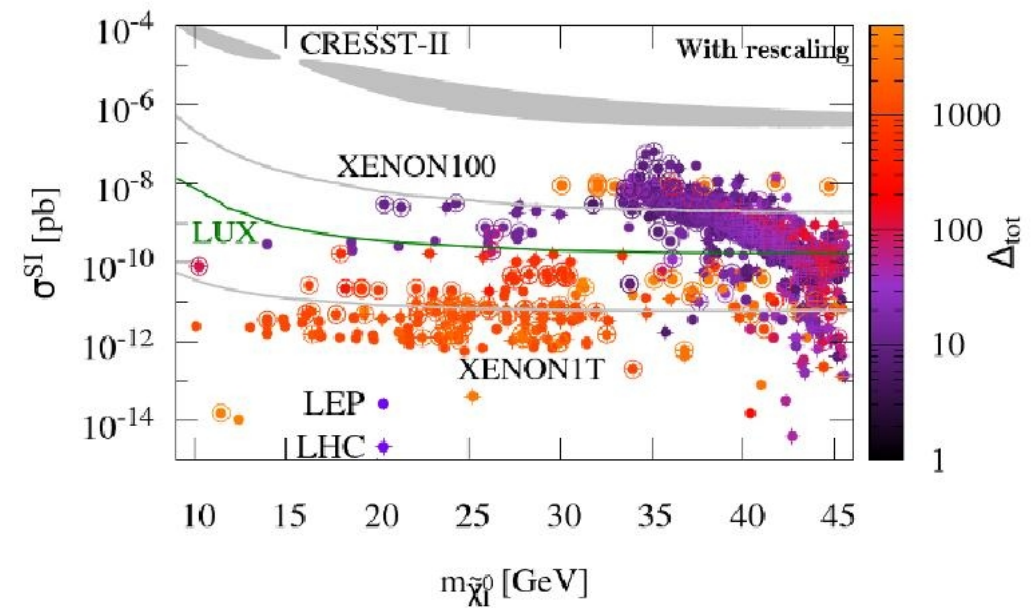
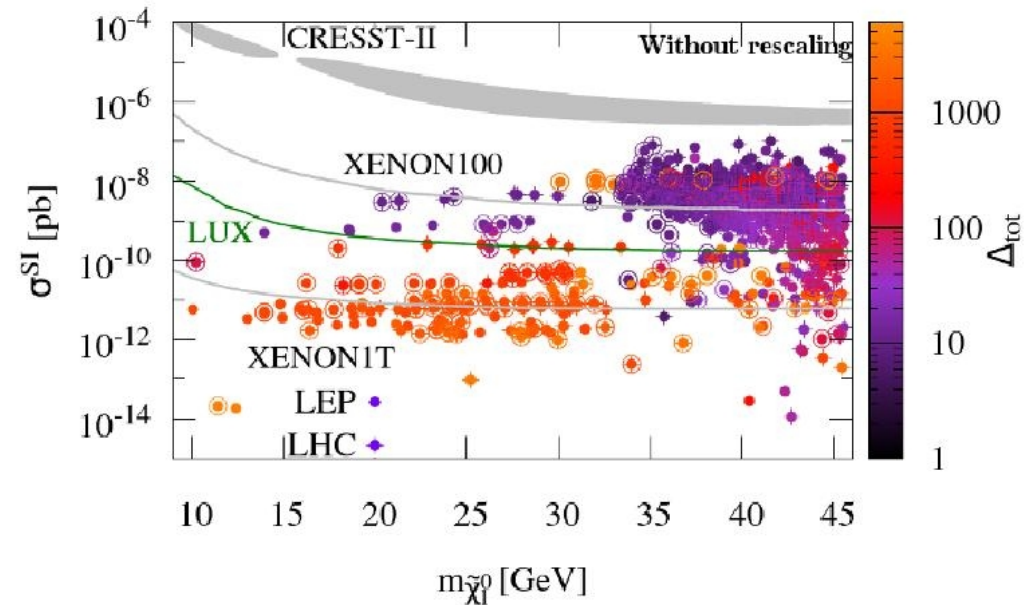

Dark Matter : beyond CMSSM \rightarrow pMSSM

we have the well know relation : $\frac{m_Z^2}{2} = \frac{m_{H_d}^2 - m_{H_u}^2 \tan^2 \beta}{\tan^2 \beta - 1} - \mu^2$

a way to quantify the degree of EW fine tuning is by using log derivatives :

$$\Delta p_i = \left| \frac{\partial \ln m_Z^2(p_i)}{\partial \ln p_i} \right| = \left| \frac{p_i}{m_Z^2} \frac{\partial m_Z^2}{\partial p_i} \right| \quad \text{where : } p_i = \left\{ \mu^2, B\mu, m_{H_u}^2, m_{H_d}^2 \right\}$$

are the parameters that determine the observable m_Z at tree level

the total measure of EWFT is defined as :

$$\Delta_{\text{tot}} = \sqrt{(\Delta \mu^2)^2 + (\Delta B\mu)^2 + (\Delta m_{H_u}^2)^2 + (\Delta m_{H_d}^2)^2}$$

$$\Delta \mu^2 = \frac{4\mu^2}{m_Z^2} \left(1 + \frac{m_A^2 + m_Z^2}{m_A^2} \tan^2 2\beta \right) \quad \Delta B\mu = \left(1 + \frac{m_A^2}{m_Z^2} \right) \tan^2 2\beta$$

$$\Delta m_{H_u}^2 = \left| \frac{1}{2} \cos 2\beta + \frac{m_A^2}{m_Z^2} \cos^2 \beta - \frac{\mu^2}{m_Z^2} \right| \left(1 - \frac{1}{\cos 2\beta} + \frac{m_A^2 + m_Z^2}{m_A^2} \tan^2 2\beta \right)$$

$$\Delta m_{H_d}^2 = \left| -\frac{1}{2} \cos 2\beta + \frac{m_A^2}{m_Z^2} \sin^2 \beta - \frac{\mu^2}{m_Z^2} \right| \left(1 + \frac{1}{\cos 2\beta} + \frac{m_A^2 + m_Z^2}{m_A^2} \tan^2 2\beta \right)$$

Dark Matter : beyond CMSSM \rightarrow pMSSM (more)

$$\xi = \frac{\Omega h^2}{0.1189}$$

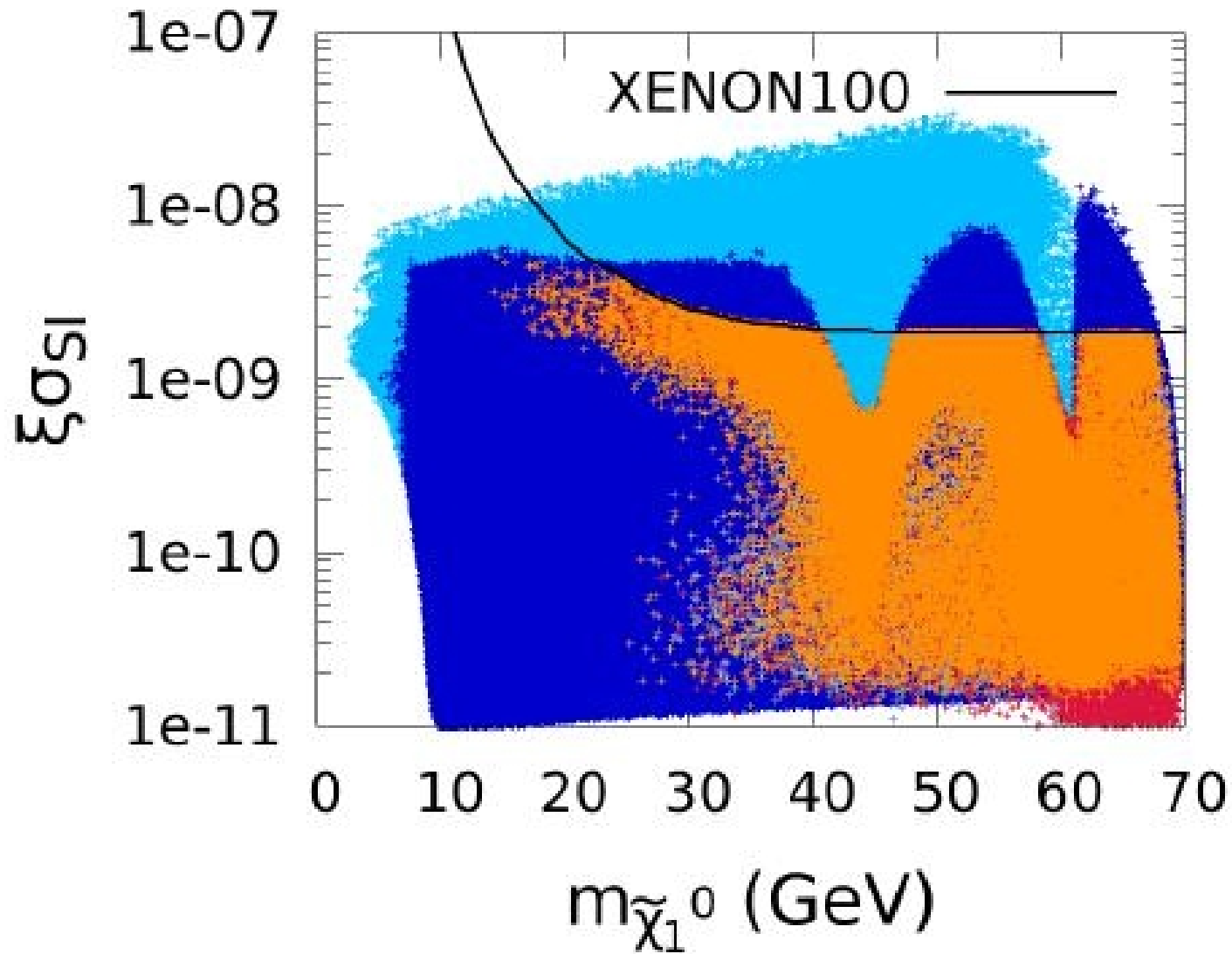

Neutralino DM with light staus

The End of the CMSSM Coannihilation Strip is Nigh

Matthew Citron¹, John Ellis^{2,3}, Feng Luo², Jad Marrouche¹,
Keith A. Olive^{4,5} and Kees J. de Vries¹

A recent global fit to the CMSSM incorporating current constraints on supersymmetry, including missing transverse energy searches at the LHC, $\text{BR}(B_s \rightarrow \mu^+ \mu^-)$ and the direct XENON100 search for dark matter, favours points towards the end of the stau-neutralino ($\tilde{\tau}_1 - \chi$) coannihilation strip with relatively large $m_{1/2}$ and $10 \lesssim \tan \beta \lesssim 40$ and points in the H/A rapid-annihilation funnel with $\tan \beta \sim 50$. The coannihilation points typically have $m_{\tilde{\tau}_1} - m_\chi \lesssim 5$ GeV, and a significant fraction, including the most-favoured point, has $m_{\tilde{\tau}_1} - m_\chi < m_\tau$. In such a case, the $\tilde{\tau}_1$ lifetime would be so long that the $\tilde{\tau}_1$ would be detectable as a long-lived massive charged particle that may decay inside or outside the apparatus. We show that CMSSM scenarios close to the tip of the coannihilation strip for $\tan \beta \lesssim 40$ are already excluded by LHC searches for massive charged particles, and discuss the prospects for their detection in the CMS and ATLAS detectors via time-of-flight measurements, anomalous heavy ionization or decays into one or more soft charged particles.

1) M. Citron, J. Ellis, F. Luo, J. Marrouche, K. A. Olive, K. J. de Vries, [arXiv:1212.2886](#)

2) A. Pierce, N. R. Shah, K. Freese, [arXiv:1309.7351](#)

Neutralino DM with light staus

Neutralino Dark Matter with Light Staus

Aaron Pierce, Nausheen R. Shah, and Katherine Freese¹

Abstract

In spite of rapid experimental progress, windows for light superparticles remain. One possibility is a $\mathcal{O}(100 \text{ GeV})$ tau slepton whose t -channel exchange can give the correct thermal relic abundance for a relatively light neutralino. We pedagogically review how this region arises and identify two distinct scenarios that will be tested soon on multiple fronts. In the first, the neutralino has a significant down-type higgsino fraction and relatively large rates at direct detection experiments are expected. In the second, there is large mixing between two relatively light staus, which could lead to a significant excess in the Higgs boson branching ratio to photons. In addition, electroweak superpartners are sufficiently light that direct searches should be effective.

1) M. Citron, J. Ellis, F. Luo, J. Marrouche, K. A. Olive, K. J. de Vries, [arXiv:1212.2886](#)

2) A. Pierce, N. R. Shah, K. Freese, [arXiv:1309.7351](#)

Dark Matter : Dirac gauginos (beyond N=1 ?)

effective LSP (Dirac neutralino)-nucleon elastic scattering X section

scenario : $M_{2D} = 1.5 M_{1D}$, $\mu = 1 \text{ TeV}$, $M_{\tilde{f}_L} = \text{TeV}$ and RH slepton mass adjusted so that $\Omega h^2 = 0.11$

$$M_1 = M'_1 = M_2 = M'_2 = 0, \lambda_S = \frac{\sqrt{2}}{2} g', \lambda_T = \frac{\sqrt{2}}{2} g, \tan \beta = 10$$

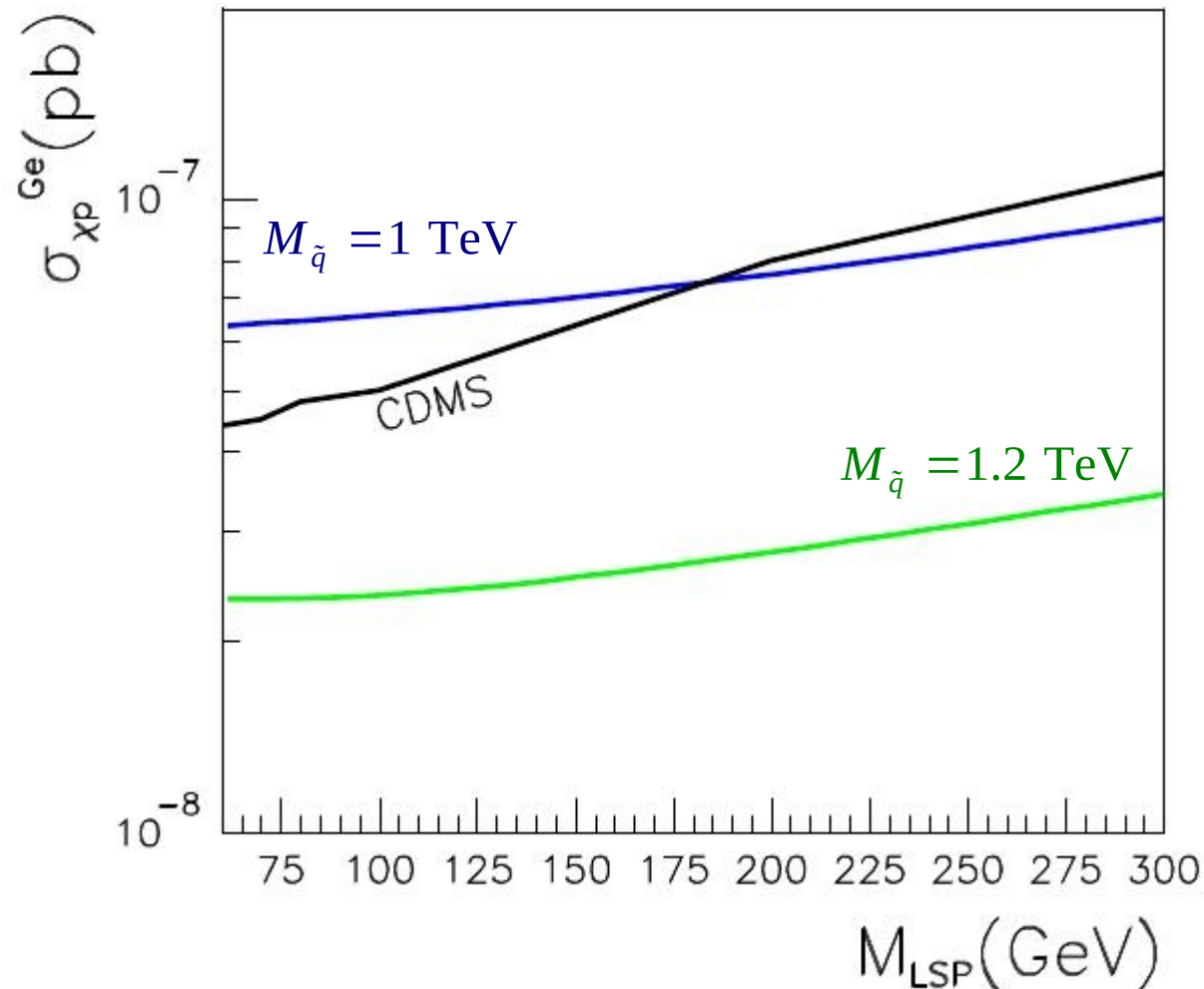

Branon Dark Matter

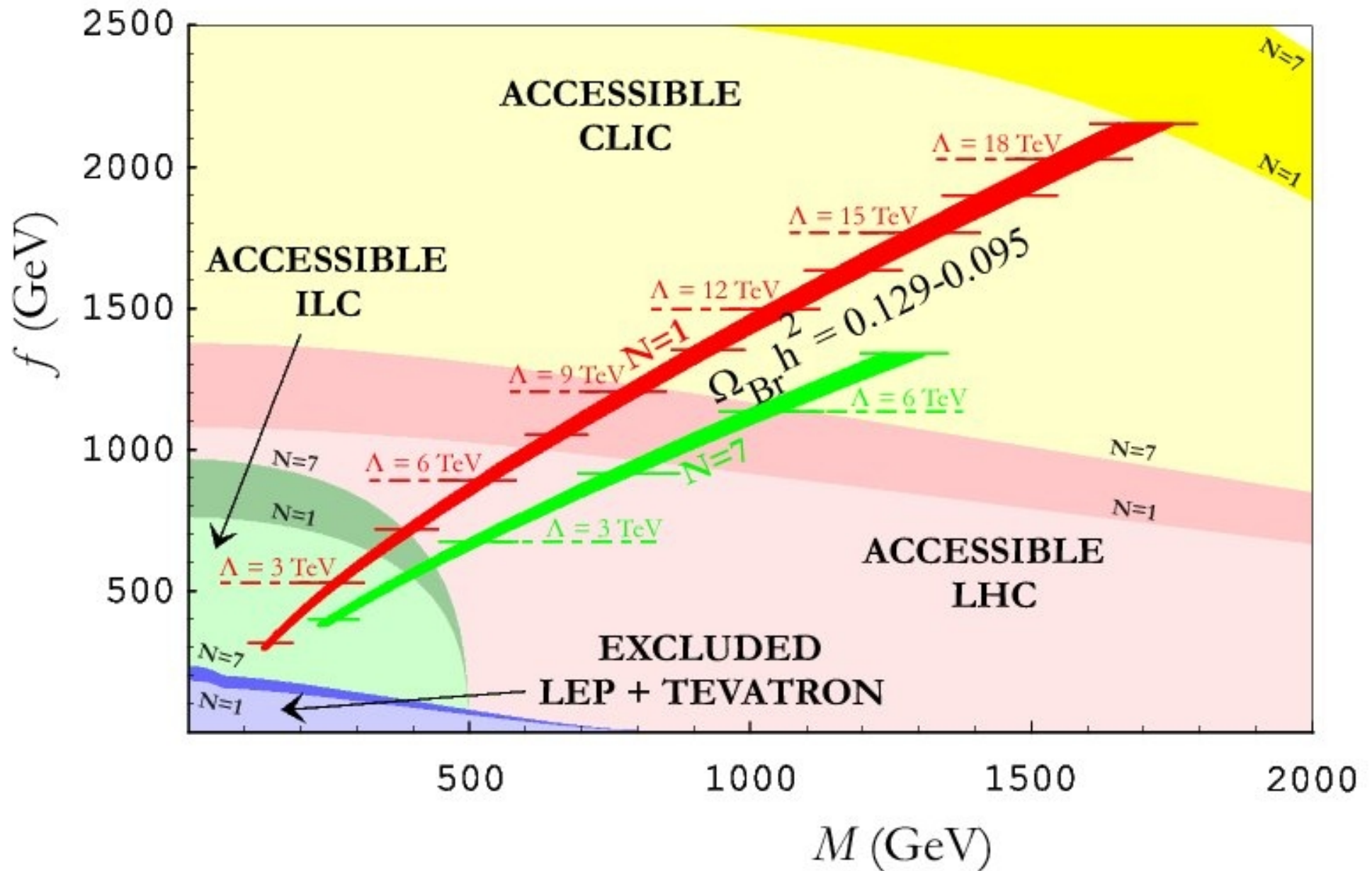

Asymmetric Dark Matter

flat directions

presence of numerous flat directions in the scalar potential of susy theories
i.e. valleys where the potential vanishes and thus where global susy is not broken

flat directions are lifted when susy is broken in particular by scalar mass terms
if a scalar mass term turns negative \rightarrow leads to instabilities which :

- can be exploited in order to spontaneously break electroweak symmetry
- but also need to be taken careed of not to break $U(1)$ QED or $SU(3)$ color as well

the need to avoid instabilities of some potentially dangerous flat directions
is generally used as a constraint in model building

having this in mind, flat directions can however also be useful for some
phenomenological purpose such as the generation of the baryon asymmetry
via the Affleck Dine mechanism

Asymmetric Dark Matter

Affleck Dine (AD) mechanisms

it makes use of the presence of numerous flat directions in the scalar potential of supersymmetric theories

indeed, let us consider one of these flat directions, labelled by the field Φ

- assume that the fundamental high energy theory, characterized by a scale M violates baryon number as for example grand unified theories
- at high energies, that is at an early stage of the evolution of the Universe, the field Φ sits along the flat direction at an arbitrary value $\Phi_0 \sim M$
- as temperature lowers, one reaches the energy scale associated with susy breaking
- the degeneracy associated with the flat direction is lifted and the field direction acquires a nontrivial structure $V(\Phi)$
- there is a priori no reason to have Φ_0 as a minimum of $V(\Phi)$
- hence the field Φ starts oscillating around the minimum of $V(\Phi)$ with a frequency of the order of its mass m_Φ

Asymmetric Dark Matter

Affleck Dine (AD) mechanisms

in this way one fulfills the 3 Sakharov requirements :

- baryon number violation from the fundamental theory
- CP violation through the CP-violating phases ϕ of the soft terms
- departure from equilibrium because of the oscillations

one generates some net baryon number

$$n_B \sim \phi m_\phi |A(t)|^2 \left(\frac{\Phi_o^2}{M^2} \right)$$

where $A(t)$ is the amplitude of oscillations at time t

Asymmetric Dark Matter

Affleck Dine (AD) mechanisms

going one step further including inflation in the picture

in classic AD inflation induces supersymmetry breaking terms proportional to the Hubble parameter H that drive a B-L carrying field ϕ to take a non-zero vev

$$V_{\text{soft}} = \sum_{\Phi} \left(a_{\Phi} m^2 + b_{\Phi} H^2 \right) |\Phi|^2$$

ADogenesis extend the generation of B-L to a simultaneous generation of B-L and D making use of supersymmetric flat directions that carry both global quantum numbers

ADM and conventional EFT approaches

$\Delta\mathcal{L}$	Int.	Suppression
$\mathcal{O}_s^\phi : \frac{1}{\Lambda} \phi^\dagger \phi \bar{f} f$	SI	1
$\mathcal{O}_v^\phi : \frac{1}{\Lambda^2} \phi^\dagger \partial^\mu \phi \bar{f} \gamma_\mu f$	SI	1
$\mathcal{O}_{va}^\phi : \frac{1}{\Lambda^2} \phi^\dagger \partial^\mu \phi \bar{f} \gamma_\mu \gamma^5 f$	SD	v^2
$\mathcal{O}_p^\phi : \frac{1}{\Lambda} \phi^\dagger \phi \bar{f} i \gamma^5 f$	SD	q^2
$\mathcal{O}_s^\psi : \frac{1}{\Lambda^2} \bar{\psi} \psi \bar{f} f$	SI	1
$\mathcal{O}_v^\psi : \frac{1}{\Lambda^2} \bar{\psi} \gamma^\mu \psi \bar{f} \gamma_\mu f$	SI	1
$\mathcal{O}_a^\psi : \frac{1}{\Lambda^2} \bar{\psi} \gamma^\mu \gamma^5 \psi \bar{f} \gamma_\mu \gamma^5 f$	SD	1
$\mathcal{O}_t^\psi : \frac{1}{\Lambda^2} \bar{\psi} \sigma^{\mu\nu} \psi \bar{f} \sigma_{\mu\nu} f$	SD	1
$\mathcal{O}_p^\psi : \frac{1}{\Lambda^2} \bar{\psi} \gamma^5 \psi \bar{f} \gamma^5 f$	SD	q^4
$\mathcal{O}_{va}^\psi : \frac{1}{\Lambda^2} \bar{\psi} \gamma^\mu \psi \bar{f} \gamma_\mu \gamma^5 f$	SD	v^2, q^2
$\mathcal{O}_{pt}^\psi : \frac{1}{\Lambda^2} \bar{\psi} i \sigma^{\mu\nu} \gamma^5 \psi \bar{f} \sigma_{\mu\nu} f$	SI	q^2
$\mathcal{O}_{ps}^\psi : \frac{1}{\Lambda^2} \bar{\psi} i \gamma^5 \psi \bar{f} f$	SI	q^2
$\mathcal{O}_{sp}^\psi : \frac{1}{\Lambda^2} \bar{\psi} \psi \bar{f} i \gamma^5 f$	SD	q^2
$\mathcal{O}_{av}^\psi : \frac{1}{\Lambda^2} \bar{\psi} \gamma^\mu \gamma^5 \psi \bar{f} \gamma_\mu f$	SI SD	v^2 q^2
$\hat{\mathcal{O}}_s^\phi : \frac{m_q}{\Lambda^2} \phi^\dagger \phi \bar{f} f$	SI	1
$\hat{\mathcal{O}}_s^\psi : \frac{m_q}{\Lambda^3} \bar{\psi} \psi \bar{f} f$	SI	1
$\hat{\mathcal{O}}_p^\psi : \frac{m_q}{\Lambda^3} \bar{\psi} \gamma^5 \psi \bar{f} \gamma^5 f$	SD	q^4

ADM and conventional EFT approaches

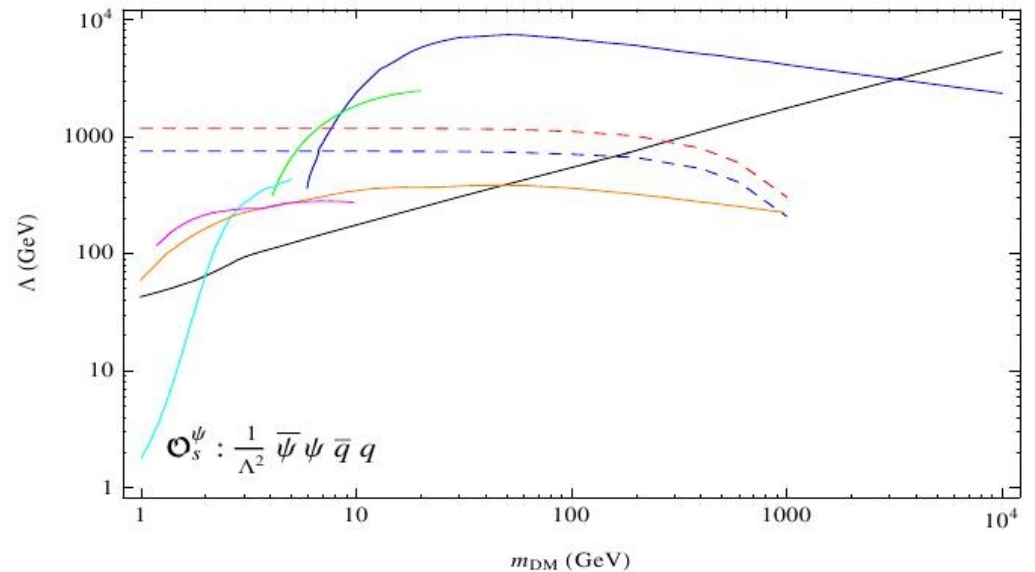
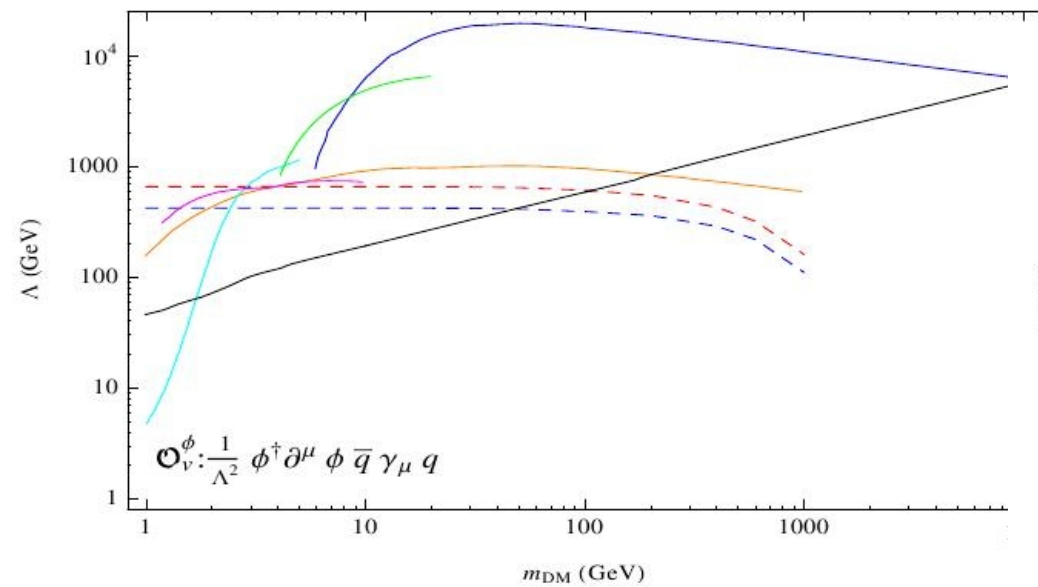
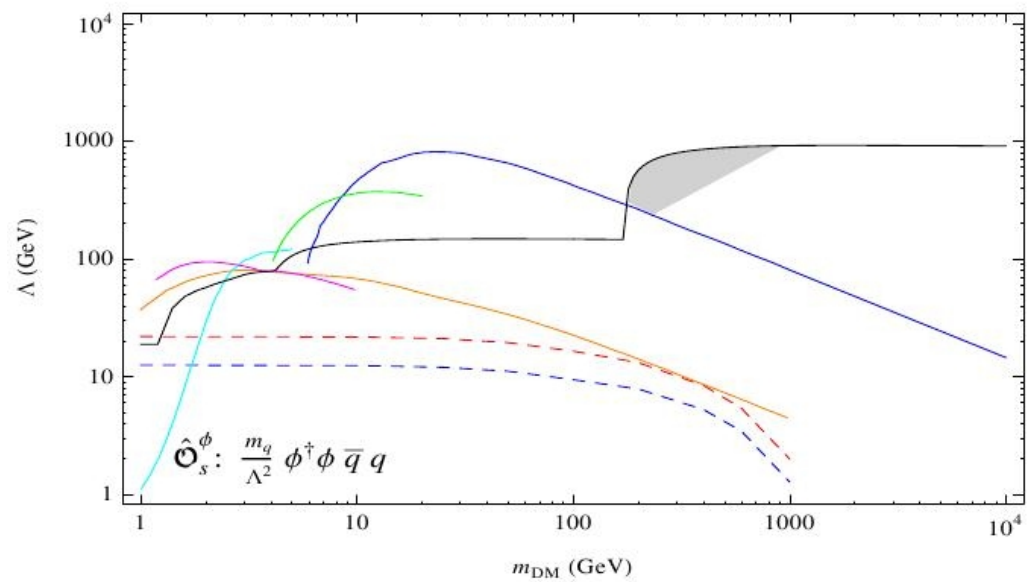
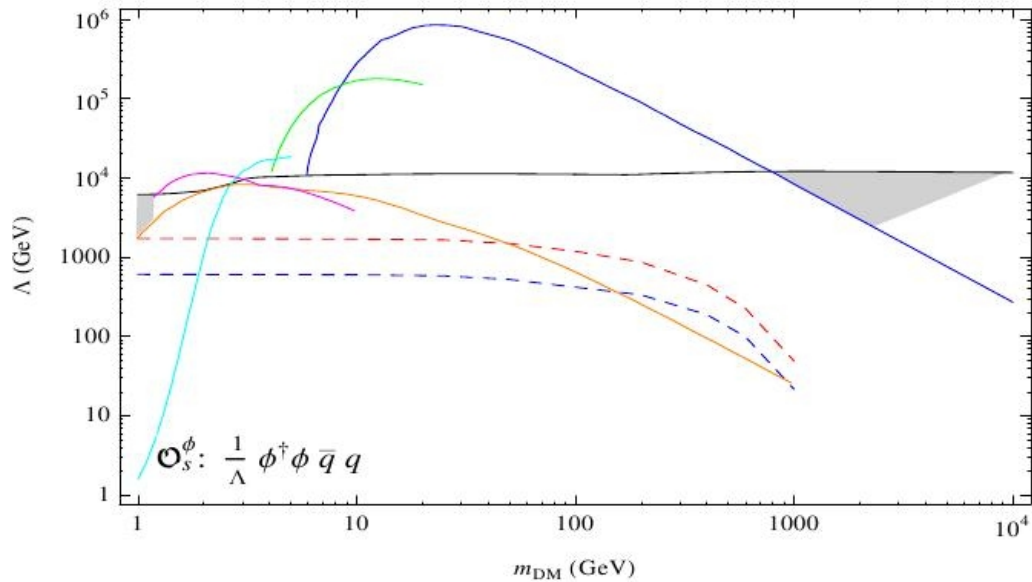

ADM and conventional EFT approaches

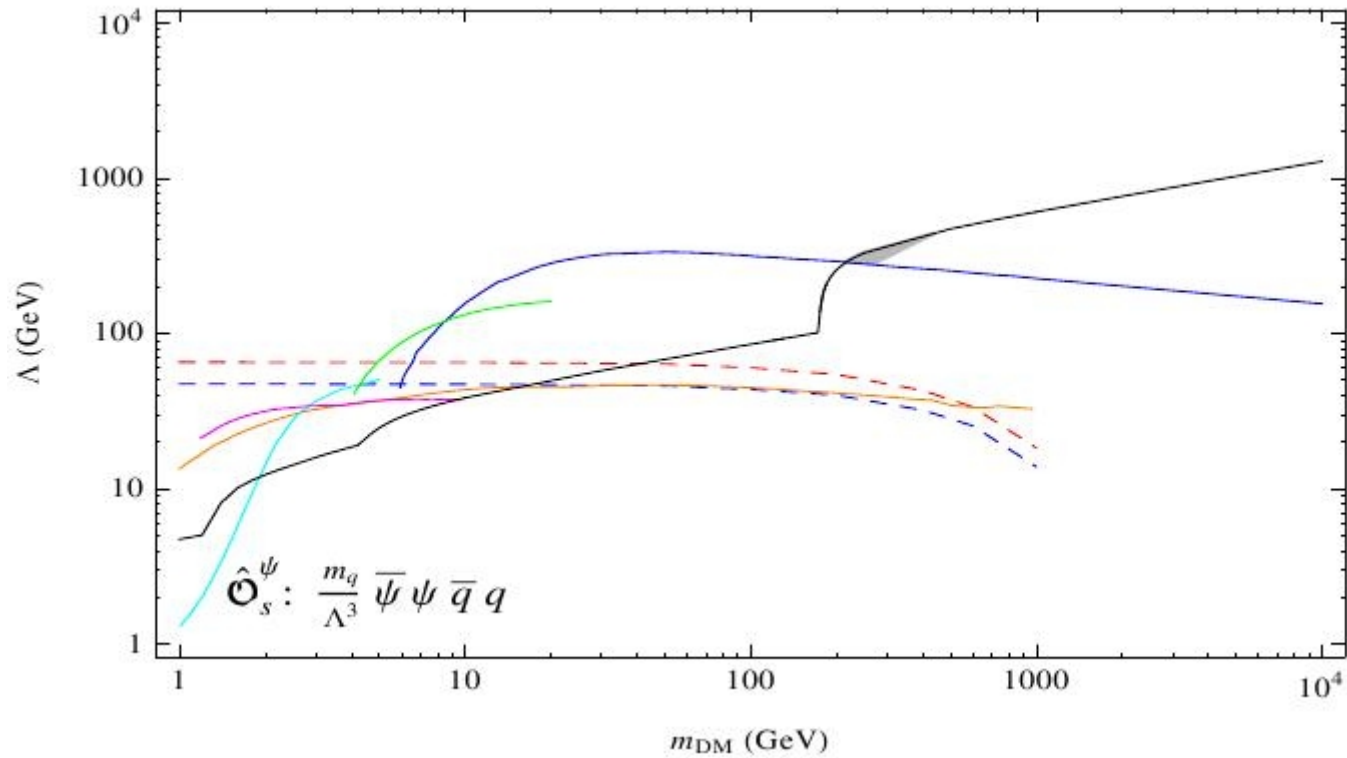

ADM and conventional EFT approaches

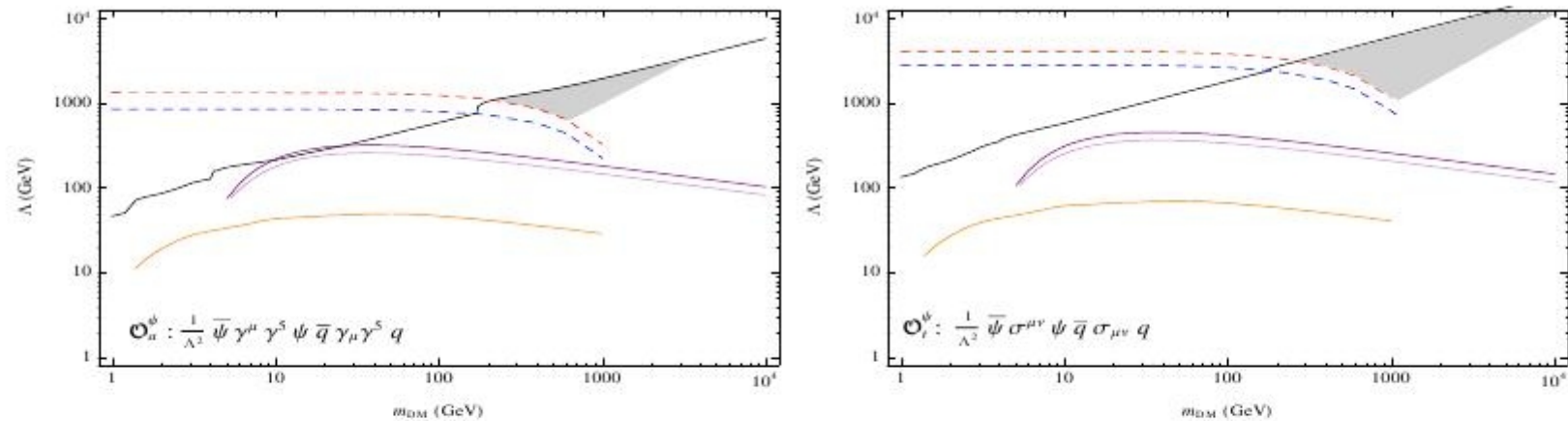

Figure 2. Limits on Λ for operators with spin-dependent direct detection cross-sections, viable parameter regions are shaded. Constraints are from Simple (Stage 2: light purple; Combined: dark purple), CRESST (orange), ATLAS 1 fb^{-1} (red, dashed) and CMS 4.67 fb^{-1} (blue, dashed).

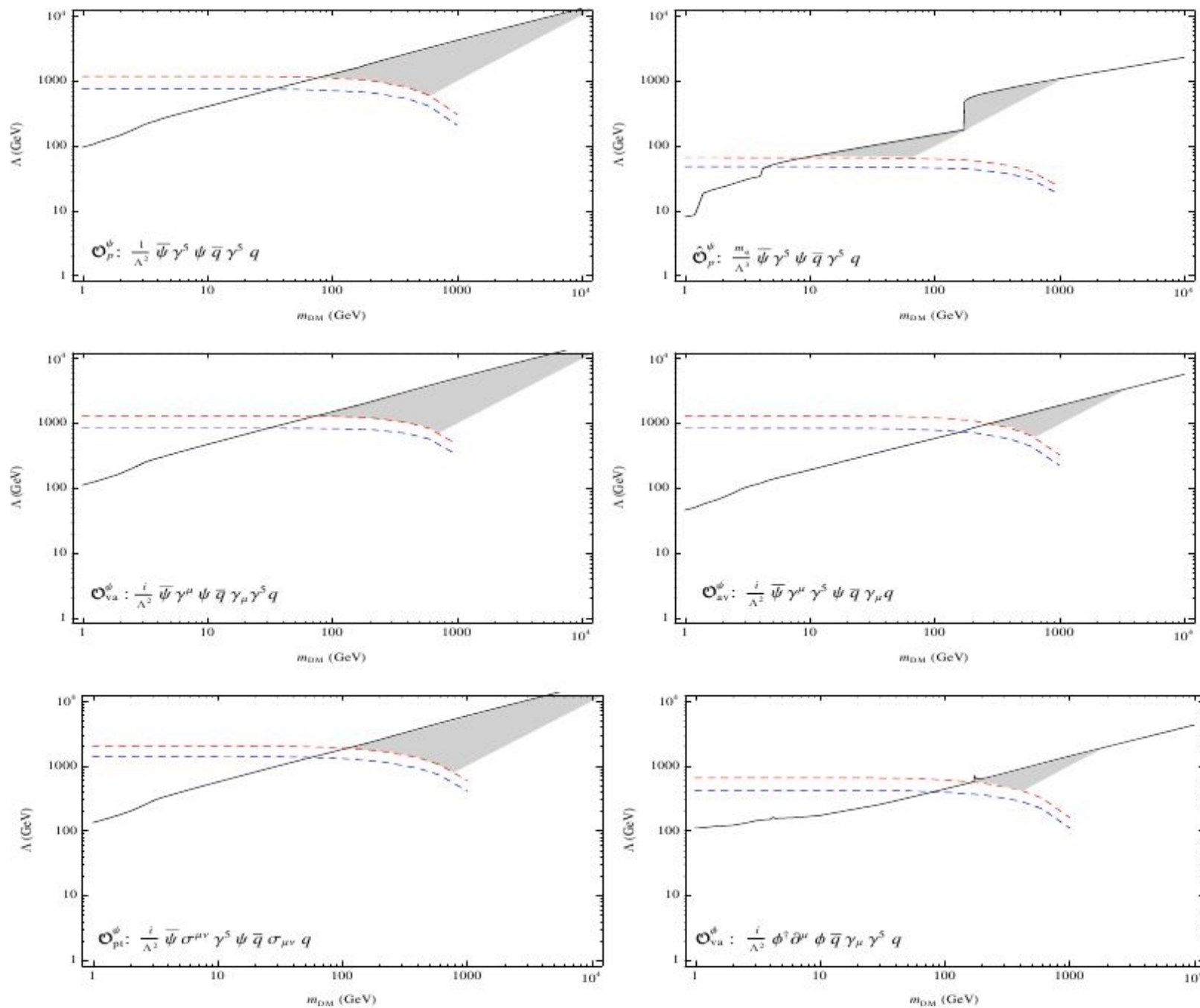

Figure 3. Limits on Λ for operators with v or q suppressed direct detection cross-sections, viable parameter regions are shaded. Limits are from ATLAS 1 fb^{-1} (red, dashed) and CMS 4.67 fb^{-1} (blue, dashed). The interesting ADM range $m_{\text{DM}} \lesssim 10 \text{ GeV}$ is excluded in all cases and, with the exception of the $\frac{m_q}{\Lambda^3} \bar{\psi} \gamma^5 \psi \bar{q} \gamma^5 q$ operator, this exclusion extends up to $m_{\text{DM}} \lesssim 100 \text{ GeV}$.

Asymmetric Dark Matter

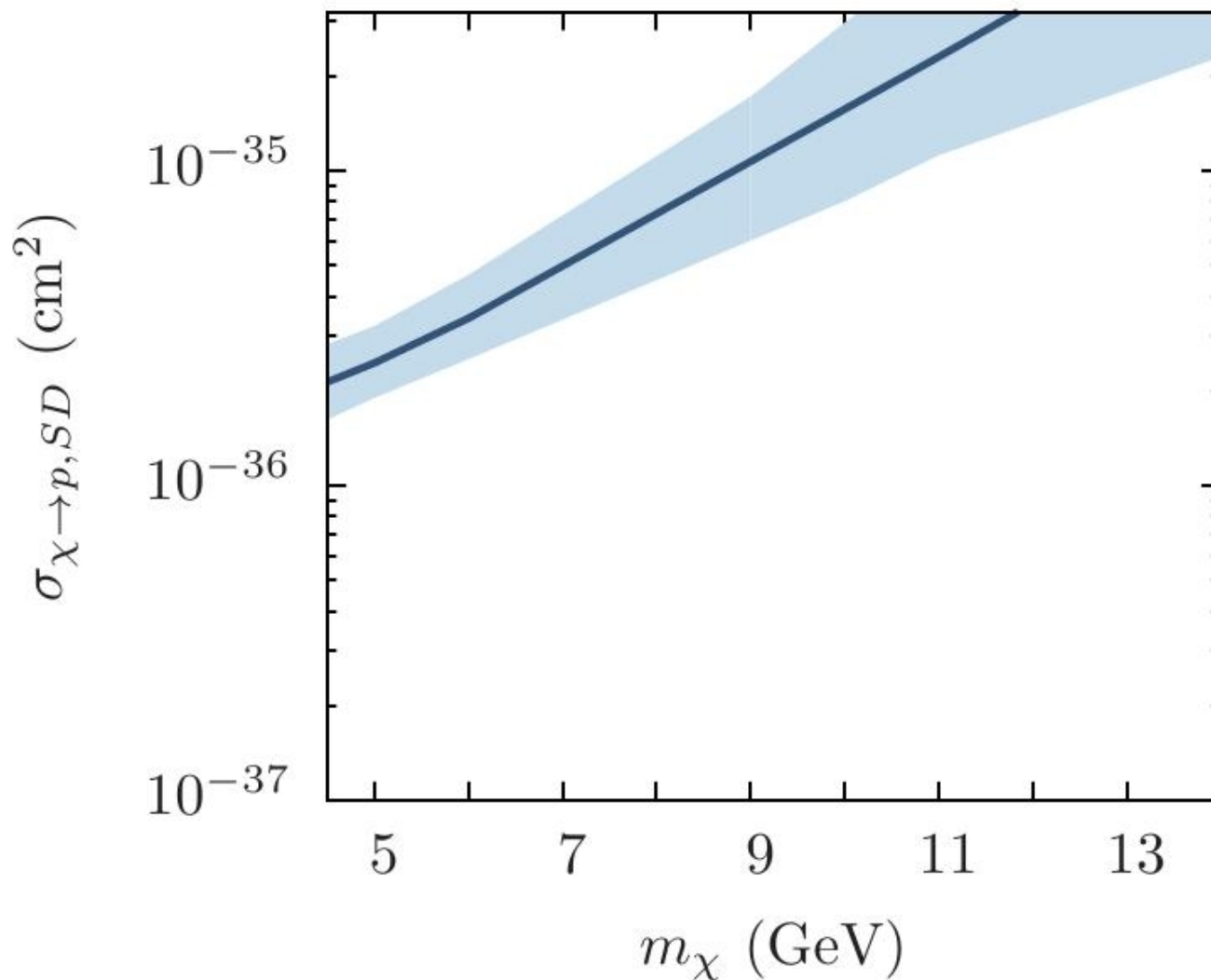

Figure 1. Upper limits for the WIMP-proton spin-dependent scattering cross section as a function of the WIMP mass from an asteroseismic analysis of the star α Cen B. Asymmetric DM particles with properties above the blue line produce a strong impact on the core of the star, leading to a mean small frequency separation more than 2σ away from the observations. The filled region shows the uncertainty in the modelling when the observational errors are taken into account. A density of $\rho_\chi = 0.4 \text{ GeV cm}^{-3}$ was assumed. Figure adapted from Ref. [50].