



Vertex Detector Mechanics

Bill Cooper
Fermilab



Issues

- Radiation lengths per layer
- Creep of carbon fiber laminate structures
- Overhang of B-layer sensors, particularly for thinner sensors
- Thermal bowing
- Barrels alone versus barrels / disks
- Longer barrels
- Sensor support during wire-bonding / bump-bonding
 - What are requirements for thin (20 μm) sensors?
 - I won't say more on this.
- Required air / gas flow for cooling
 - Would less flow work?
- Beam tube design
 - Can IR be reduced near $Z = 0$?
- EMI (task force to evaluate)
- Lorentz forces (no new ideas on this)



Barrel Radiation Lengths (Normal Incidence)

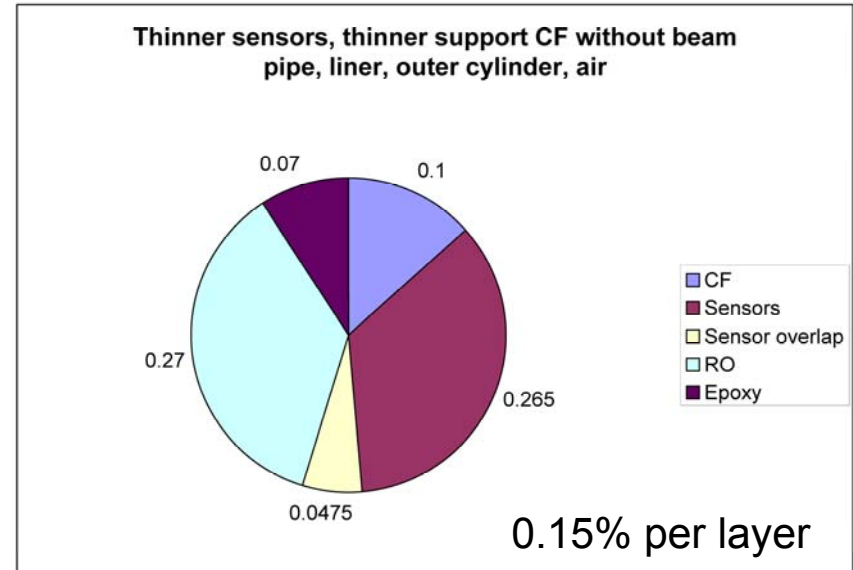
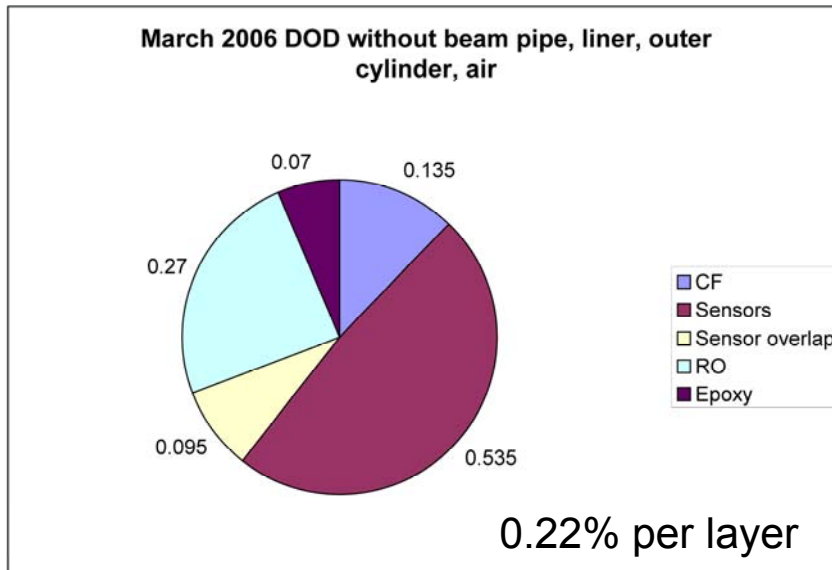
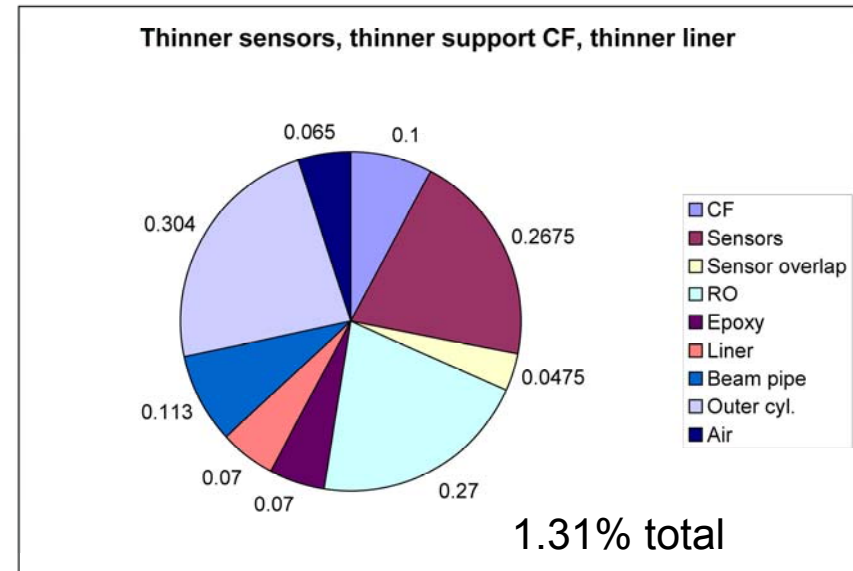
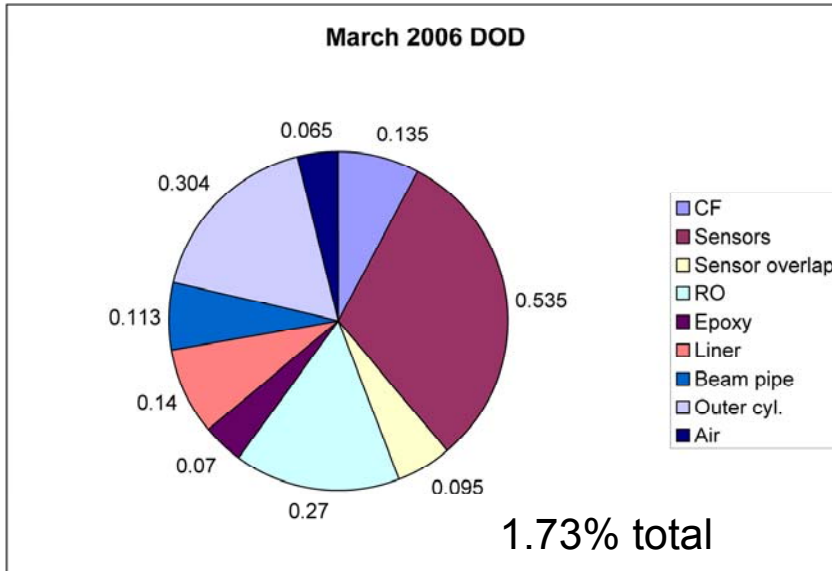



Where should we go?

- For a given beam tube and liner, what is the dependence of physics performance on radiation lengths per layer?
 - What is the basis for 0.1% of a radiation length?
- How does the radial spacing of adjacent ladders impact physics?
- With thinner sensors, contributions from readout and cabling can become dominant.
 - Can readout and cabling be defined better?
- Halving readout, cabling, and sensor overlap contributions (with 50 μm sensors) would get us to 0.12% per layer.
- Epoxy contribution assumes full coverage.
 - In all likelihood, that can be reduced by a factor of > 5 .
- How significant is the 0.3% from the outer support cylinder?
- We need to look at the disks.
 - Material reductions in the barrels should apply to disks, also.



CF Creep

- The design of VXD structures is deflection, rather than stress, limited.
 - Most material stresses are quite low → creep not likely to be significant.
 - D0 L0 support structures were measured in December 2004 and again in April 2005.
 - Load tests were reproducible at the 2-3 μm level.
 - Shape reproduced within the precision of the coordinate measuring machine ($\sim 3 \mu\text{m}$).

Deflection versus Z with 50, 100, 150 gram central loads, 10 μm divisions

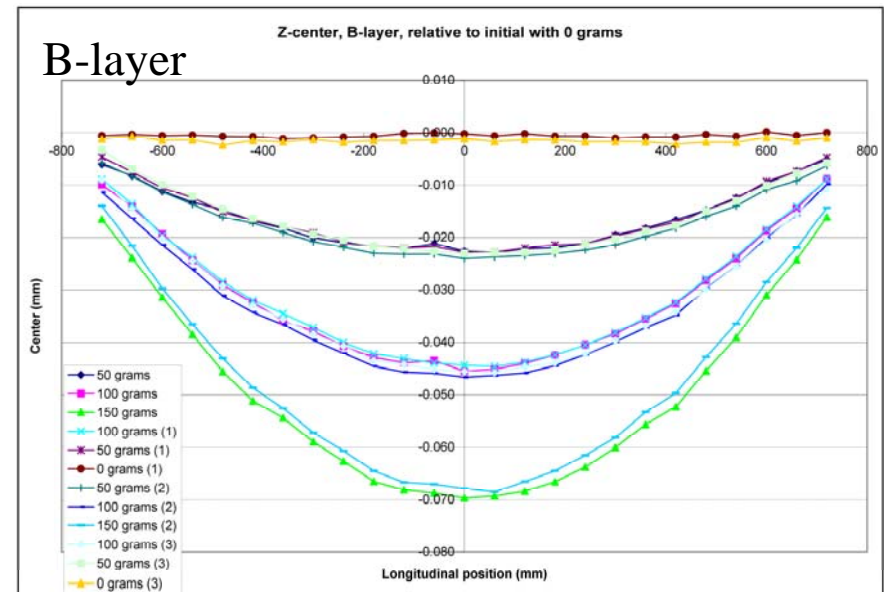
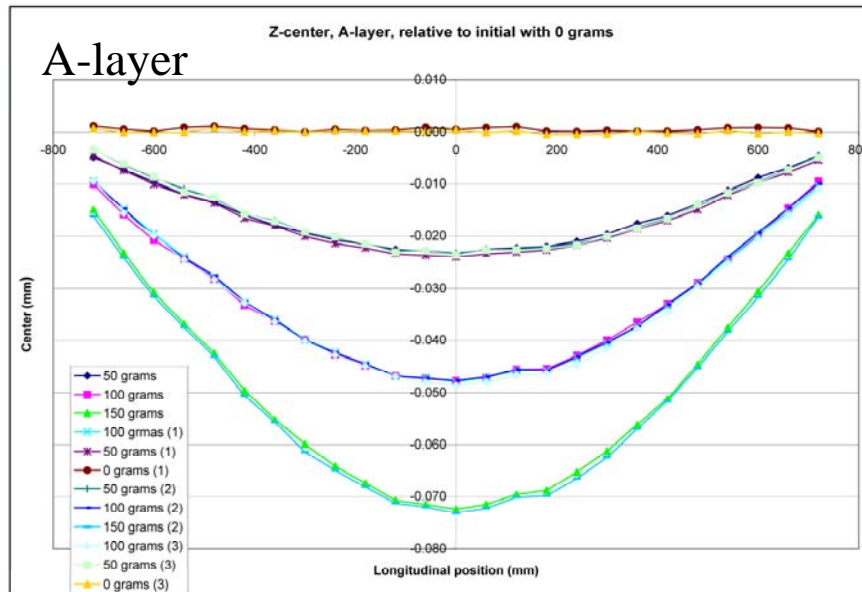



Overhanging Portion of Sensor

- B-layer sensors
 - Overhang ~ 3.3 mm
 - SiD assumption has been 0.1 mm sensor thickness
 - Others are interested in a thickness as low as 0.02 mm
 - The plot shows that thermal and humidity distortions plus sensor flatness as fabricated and mounted are the real issues, not gravity.

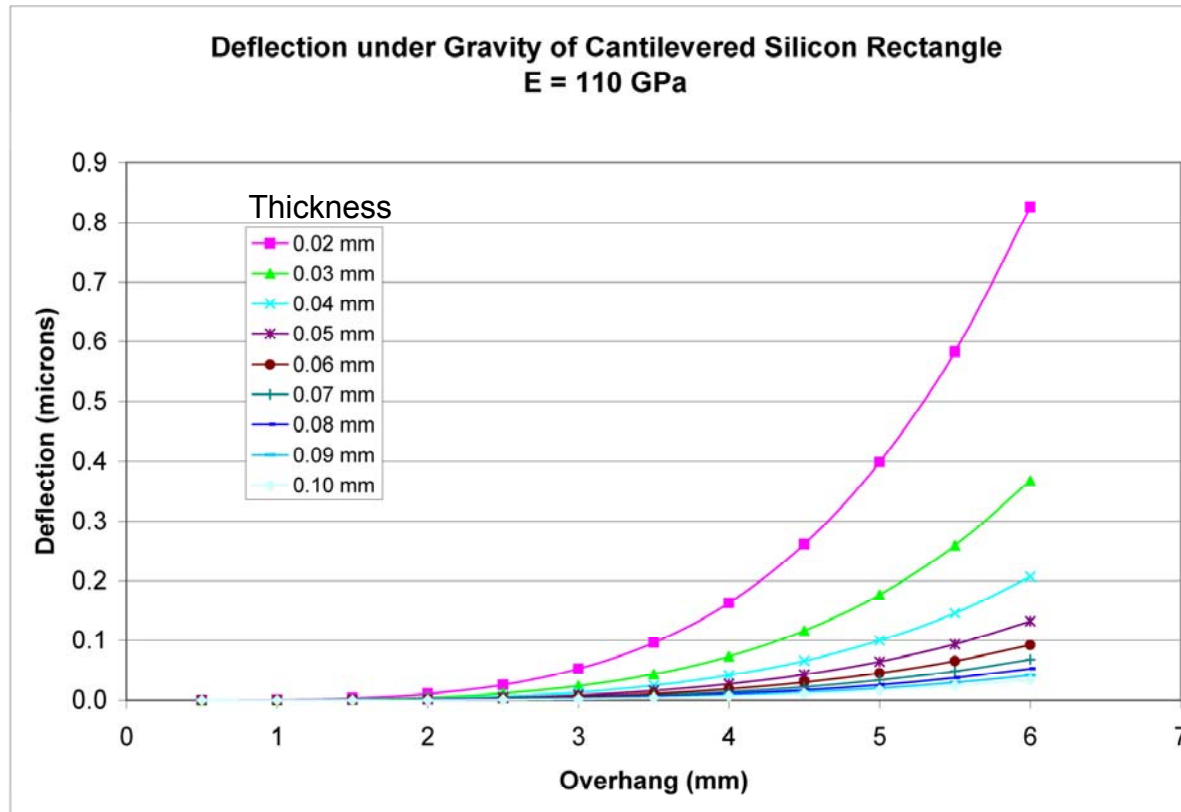



Representative Material Properties

- In general, we are interested in maximizing stiffness and minimizing the number of radiation lengths of a support structure.
- For beam-like deflection of a flat plate of fixed thickness, width, and length, deflection with gravity acting normal to the surface varies linearly with density and inversely with elastic modulus.
- We are also interested in controlling thermal distortions by minimizing differences in CTE.
- The table below suggests the choice of CF with portions removed.
- Behavior of a combined structure is more complicated.

Material	Silicon	Beryllium	CF	¼ CF
Density (g/cm ³)	2.33	1.848	1.56	0.39
Elastic modulus (GPa)	131	290	228	57
Radiation length average (cm)	9.37	35.43	24	96
Relative deflection	1	0.36	0.38	0.38
Relative number of radiation lengths (average)	1	0.26	0.39	0.10
CTE (ppm/°C)	2.6	11.6	-0.6	-0.6

CF modulus and CTE depend on the lay-up

•  • CF and CF Laminate Properties per Mitsubishi

Continuous fiber: 2K type

1.Fiber properties (Typical data)

GRADE	Tensile Strength		Tensile Modulus		Elongation	Density	Yield		Thermal Conductivity	Filament Diameter	Filament Count
	MPa	KSI	GPa	MSI	%	g/cm ³	g/1,000m	Yard/lb	W/m·K	μ	-
K1352U	3600	530	620	90	0.6	2.12	270	1800	140	10	2000
K1392U	3700	540	760	110	0.5	2.15	270	1800	210	10	2000
K13B2U	3800	550	830	120	0.5	2.16	270	1800	260	10	2000
K13C2U	3800	550	900	130	0.4	2.20	270	1800	620	10	2000
K13D2U	3700	535	935	135	0.4	2.20	365	1340	800	11	2000
K13A1L	3700	540	790	114	0.5	2.15	66	7500	220	7	1000



2.Laminate properties (Measured by MCC)

GRADE	Longitudinal											Transverse			
	Tensile Strength		Tensile Modulus		Compressive Strength		Compressive Modulus		Shear		CTE (Temp. 50-125°C)	Tensile Strength		Tensile Modulus	
	MPa	KSI	GPa	MSI	MPa	KSI	GPa	MSI	MPa	KSI	×10 ⁻⁶ /K	MPa	KSI	MPa	KSI
K1352U	2000	280	380	55	450	65	250	46	75	11	-1.1	40	5.5	6200	900
K1392U	2100	300	460	67	400	58	420	61	70	10	-1.2	35	5.0	6000	870
K13B2U	2200	310	490	71	380	55	450	65	60	9	-1.2	30	4.0	5500	800
K13C2U	2200	310	560	81	380	55	560	81	50	7	-1.2	30	4.0	5400	780
K13D2U	2000	290	560	81	350	50	560	81	40	6	.	30	4.0	5100	740





Elastic Properties of K13D2U/Epoxy Prepreg

Mark E. Tuttle, University of Washington
tuttle@u.washington.edu

http://d0server1.fnal.gov/projects/run2b/silicon/mechanical/UW/Elastic_Properties_of_Pre-preg.ppt

K13D2U properties were studied quite carefully in 2002. For later structures, we chose K13C2U, which has similar properties and is easier to handle.



Finite Element Analysis (FEA)

- An initial model was developed by Colin Daly (University of Washington) to represent the barrel 1 carbon fiber (CF) support structure, sensors, and epoxy which holds sensors in place.
- All sensors are on the outer surface of the carbon fiber (CF).
- A & B layers have been placed leaving 0.54 mm from the edge of an A-layer sensor to the surface of a B-layer sensor.
- All barrel 1 sensors are shown 9.6 mm wide (9.1 mm active).
- B-layer sensors overhang CF ~3.3 mm.

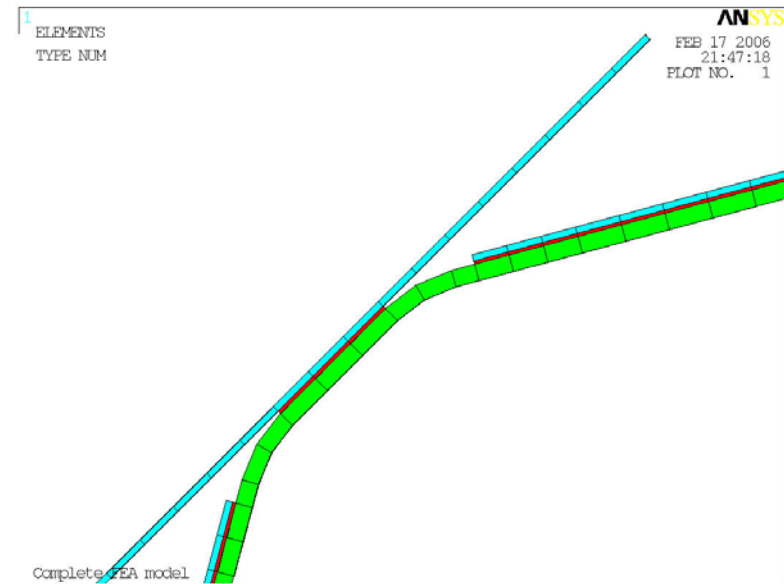
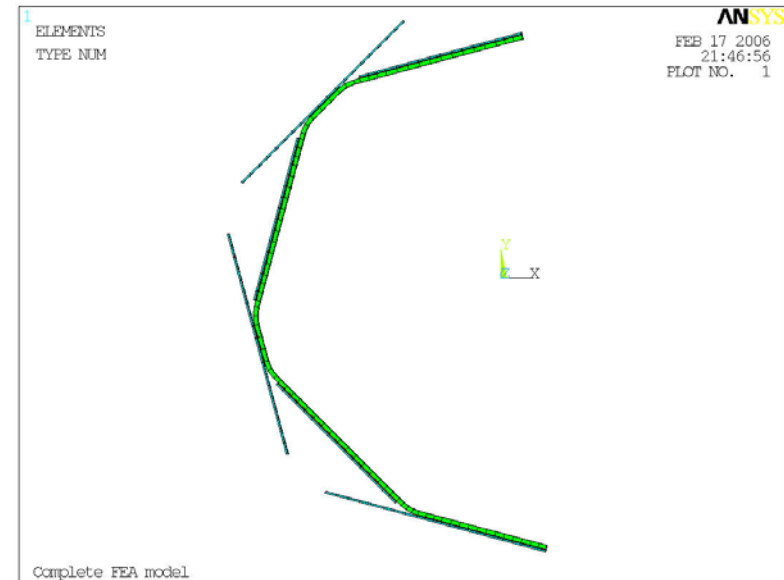



SiD Half Barrel (Innermost Barrel)

- 3 layers of K13C pre-preg (had been 4 layers)
- Composite thickness = 0.195 mm
- 0/90/0 degree lay-up
- CF strut width = 2 mm
- Sensor width for this barrel = 9.6 mm (could change)
- 0.1 mm silicon
- 0.05 mm epoxy
- End rings included

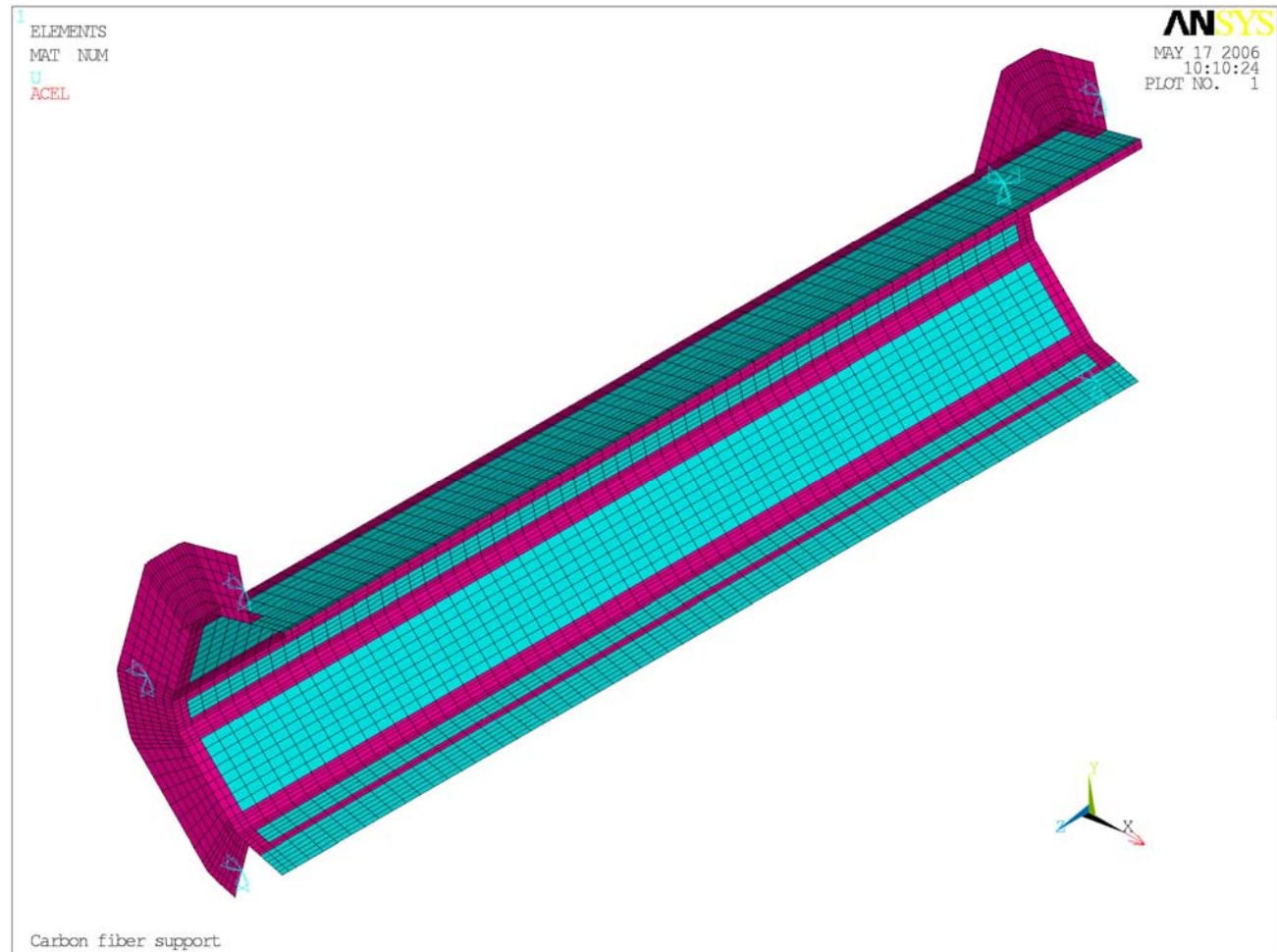



SiD Half Barrel (Innermost Barrel)

- Deflection with gravity acting vertically = 1.6 μm
- Demonstrates the benefits of a support structure with larger transverse dimensions
- Innermost barrel tests beam-like deflections
- Next to outermost barrel will test out-of-round deflections (not done yet)

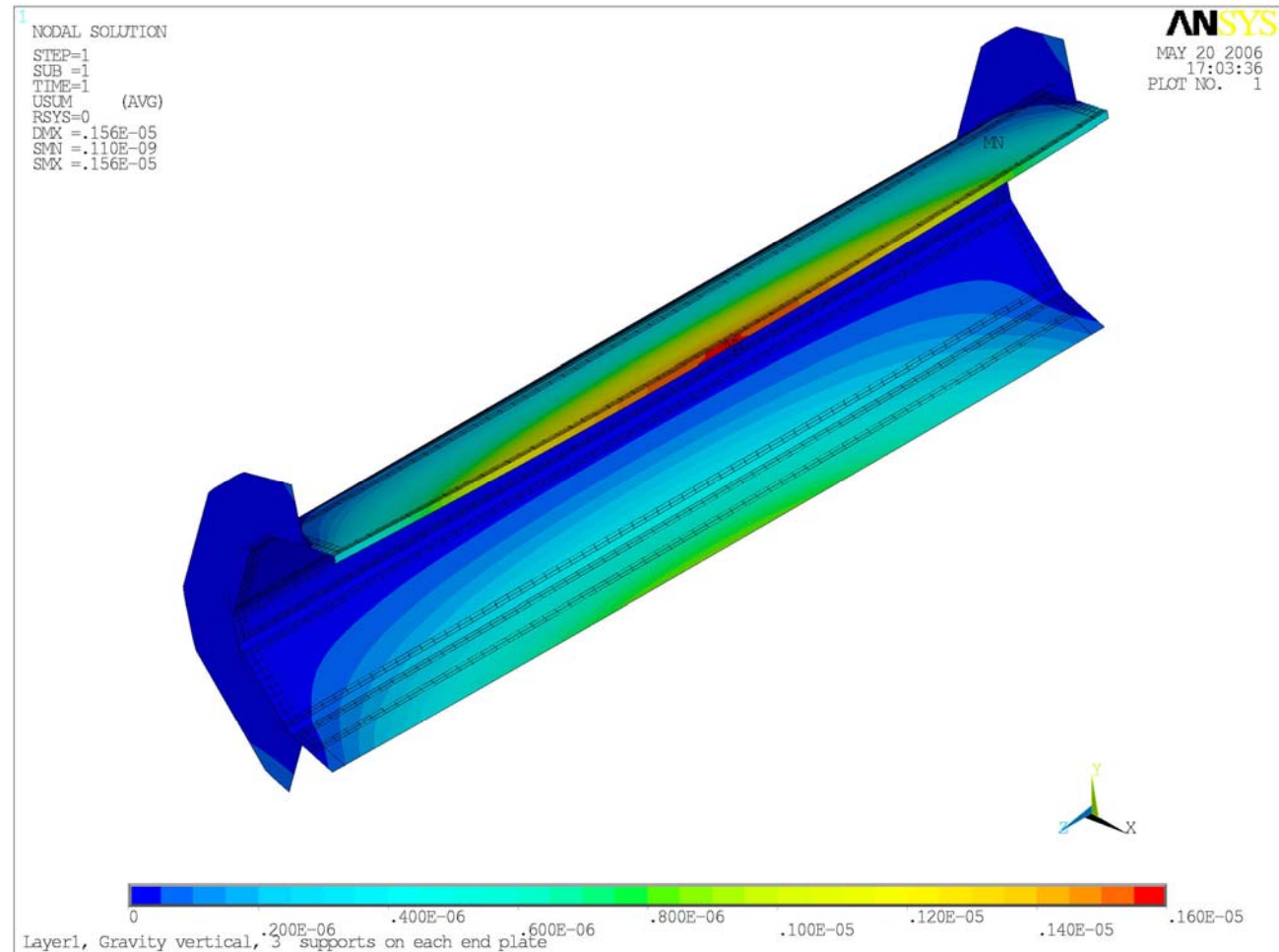



SiD Half Barrel (Innermost Barrel)

- Deflection with gravity acting horizontally = $0.5 \mu\text{m}$
- Suggests a split at equator works better
 - A surprise to some of us
- The good results suggest that uncontrolled loading from cables and fibers at the ends may not be so much of a problem.
- Lorentz force loadings have been raised as a possible concern.

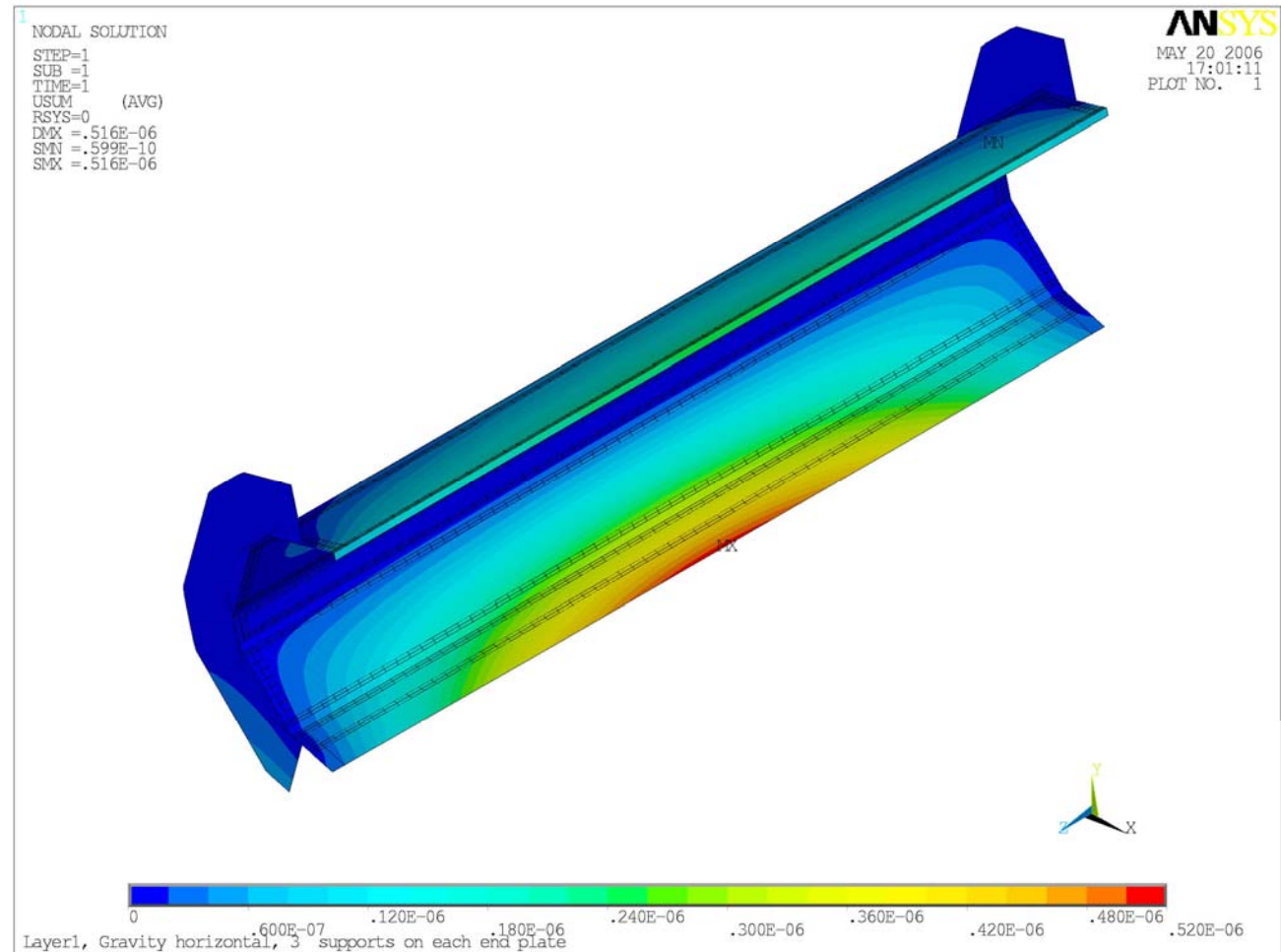



Thermal Distortions

- Finite element analysis of thermal bowing is just beginning.
- An initial analysis indicates we will need to pay attention.
- Measures adopted in attaching sensors to beryllium substrates (local glue “towers”) will be evaluated.
 - Thermal mismatch to CF ~ a factor of 3 less than to CF



Barrels Alone versus Barrels / Disks

- Barrel lengths suggested were 250 mm (LDC) and 130, 200 mm (GLD).
 - GLD length may work with 8" wafers if length is shortened slightly (not said during Ringberg workshop).
- GLD concept showed three double layers with ~ 2 mm spacing between sub-layers (20, 22, 32, 34, 48, 50 mm radius in one of three concepts).
 - Sub-layers are two surfaces of a ladder.
 - Separated by foam or similar material
 - Disks included in GLD concept.

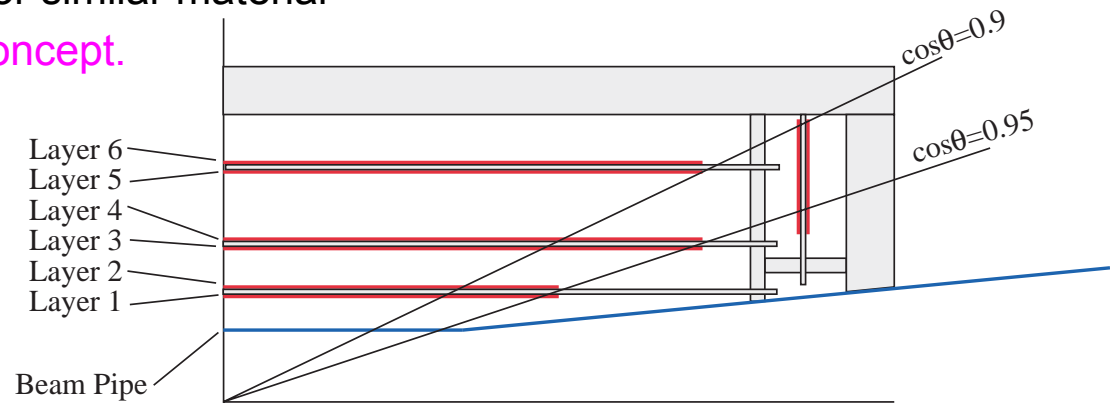

- Two basic issues for long ladders:
 - Trade-off between deflection and the number of radiation lengths represented by ladder spacers
 - Longitudinal overlap between sensors if multiple sensors are needed
 - LDC will investigate



SiD VXD Elevation View

- 5-layer pixel barrel: $Z = \pm 62.5$ mm; 14 mm $< R < 61$ mm
- 4 pixel disks per end: $Z = \pm 72, \pm 92, \pm 123, \pm 172$ mm; $R < 71$ mm
- 3 forward disks per end: $Z = \pm 208, \pm 542, \pm 833$ mm; $R < 166$ mm
 - Could be pixels or pairs of micro-strips
- Coverage extends to $\cos(\theta) = \pm 0.99$.

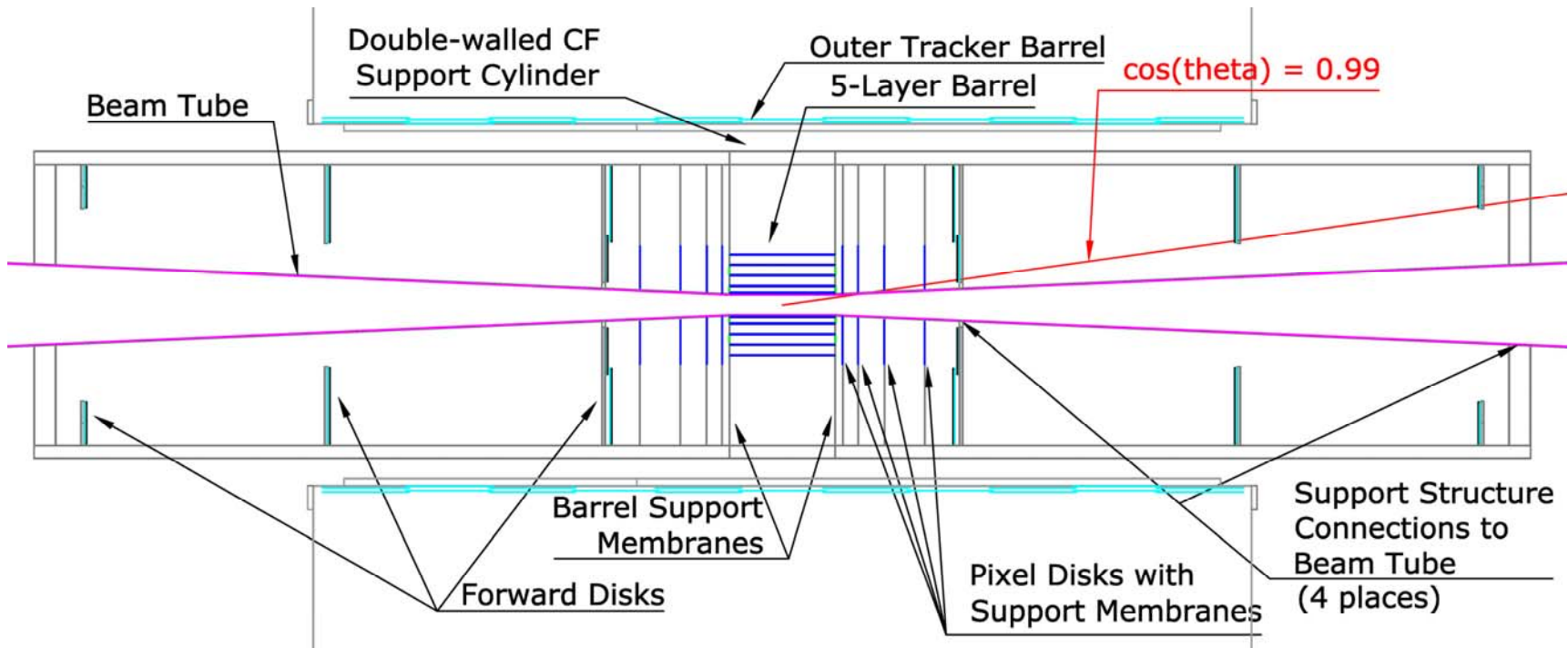



Beam Pipe Deflections

- For these calculations, an all-beryllium beam pipe was assumed.
 - Wall thickness of 0.25 mm was assumed in the central, straight portion.
- The radius of conical portions was assumed to increase with $dR/dZ = 17/351$.
 - Wall thickness in the conical portions was chosen to correspond to collapse at slightly over 2 Bar external pressure.
- An inner detector mass of 500 g was assumed to be simply supported from the beam pipe at $Z = \pm 900$ mm.

Inner detector weight contributes ~ 0.008 mm.

Maximum stress ~ 20 MPa

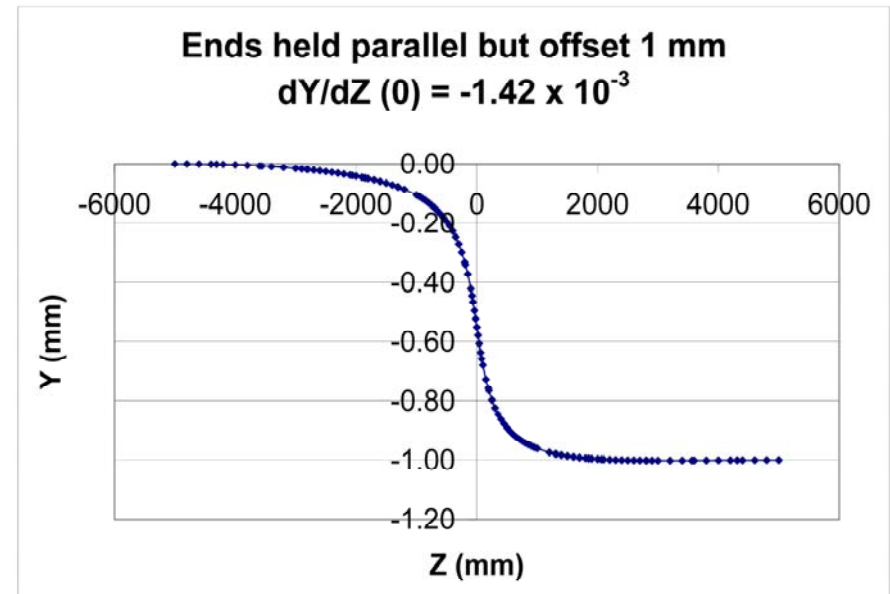
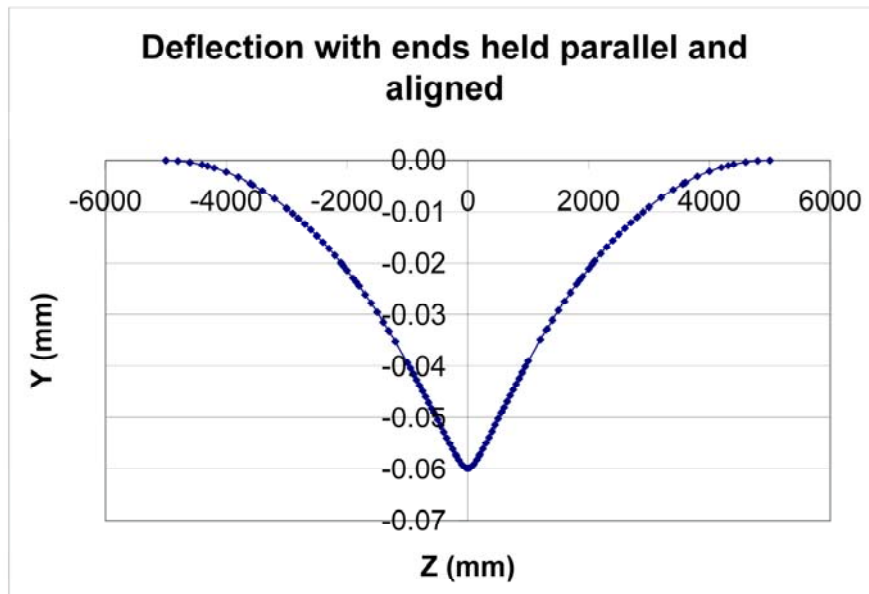

Beam Pipe Deflections

- A basic assumption has been that the beam pipe would be guided, not just simply supported, at its ends.
- If one insists that the beam pipe be simply supported (for example to allow bellows), then the outer support cylinder for the vertex detector could be extended to ± 1.85 m.
- Connect to beam pipe at ± 1.85 m and ± 0.90 m (not optimized).

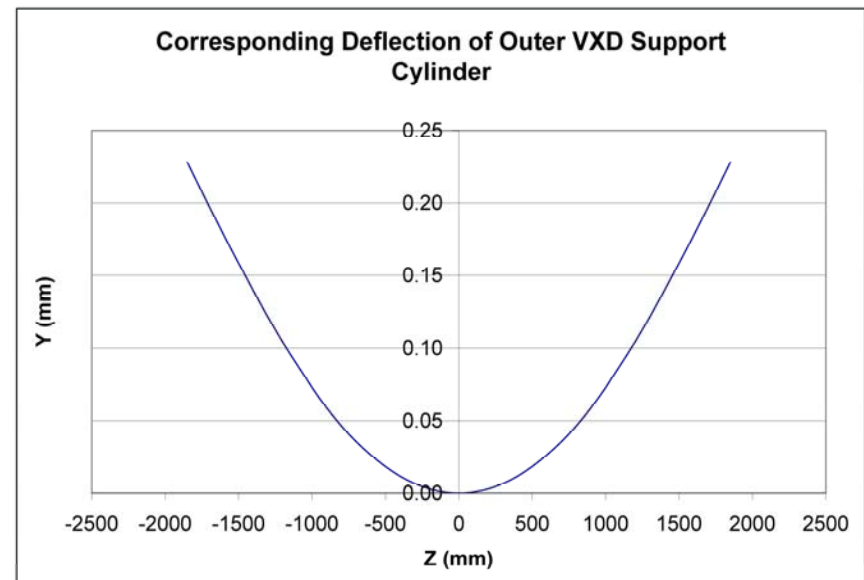
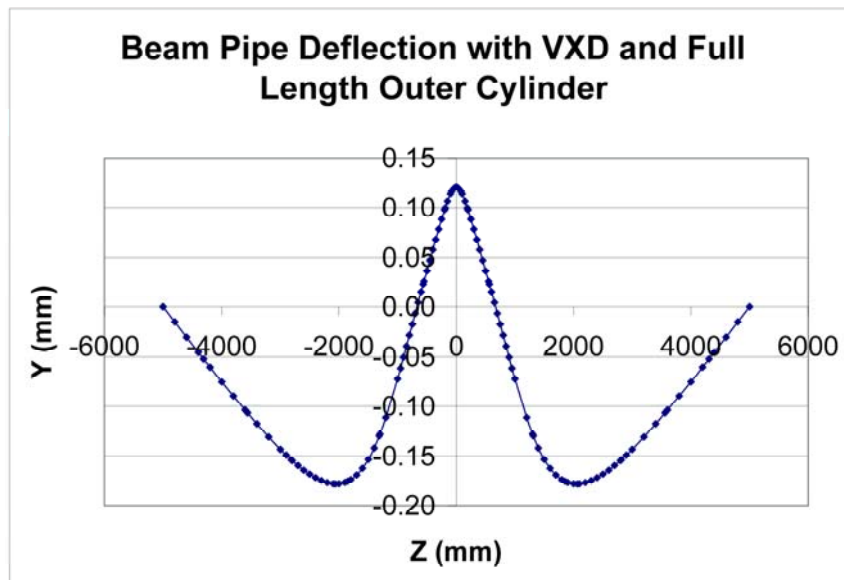

- Calculations remain to be made with a beam pipe which is partially of denser material, such as stainless steel. **Could raise issues!**

VXD Barrel Cooling

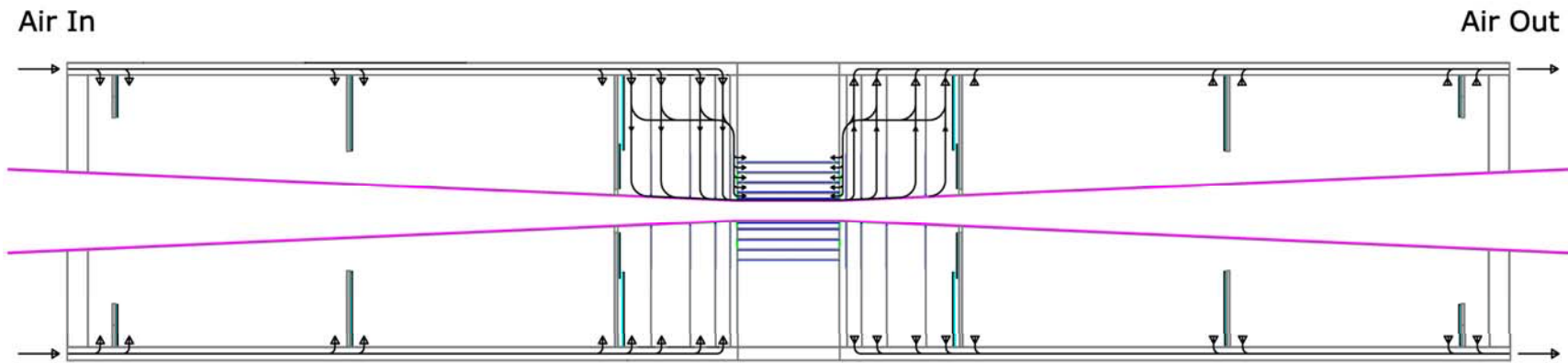

- Dry air was assumed to enter the barrel at a temperature of -15°C .
- We assumed no heat transfer from the beam pipe to the innermost layer, that is, the beam pipe would have thermal intercepts.
- A total power dissipation of 20 watts was assumed for the barrel.
 - Based upon the results, that seems reasonable.

Cooling performance as a function of Reynold's number

Reynold's number	Total barrel flow (g/s)	Ave. ΔT air ($^{\circ}\text{C}$)	Max sensor T ($^{\circ}\text{C}$)
800	9.0	2.21	-2.44
1200	13.5	1.47	-4.61
1800	20.2	0.98	-6.36

- Flow rates are conservative with respect to temperature variation within the barrel with power on / off for individual sensors.



VXD Barrel Cooling

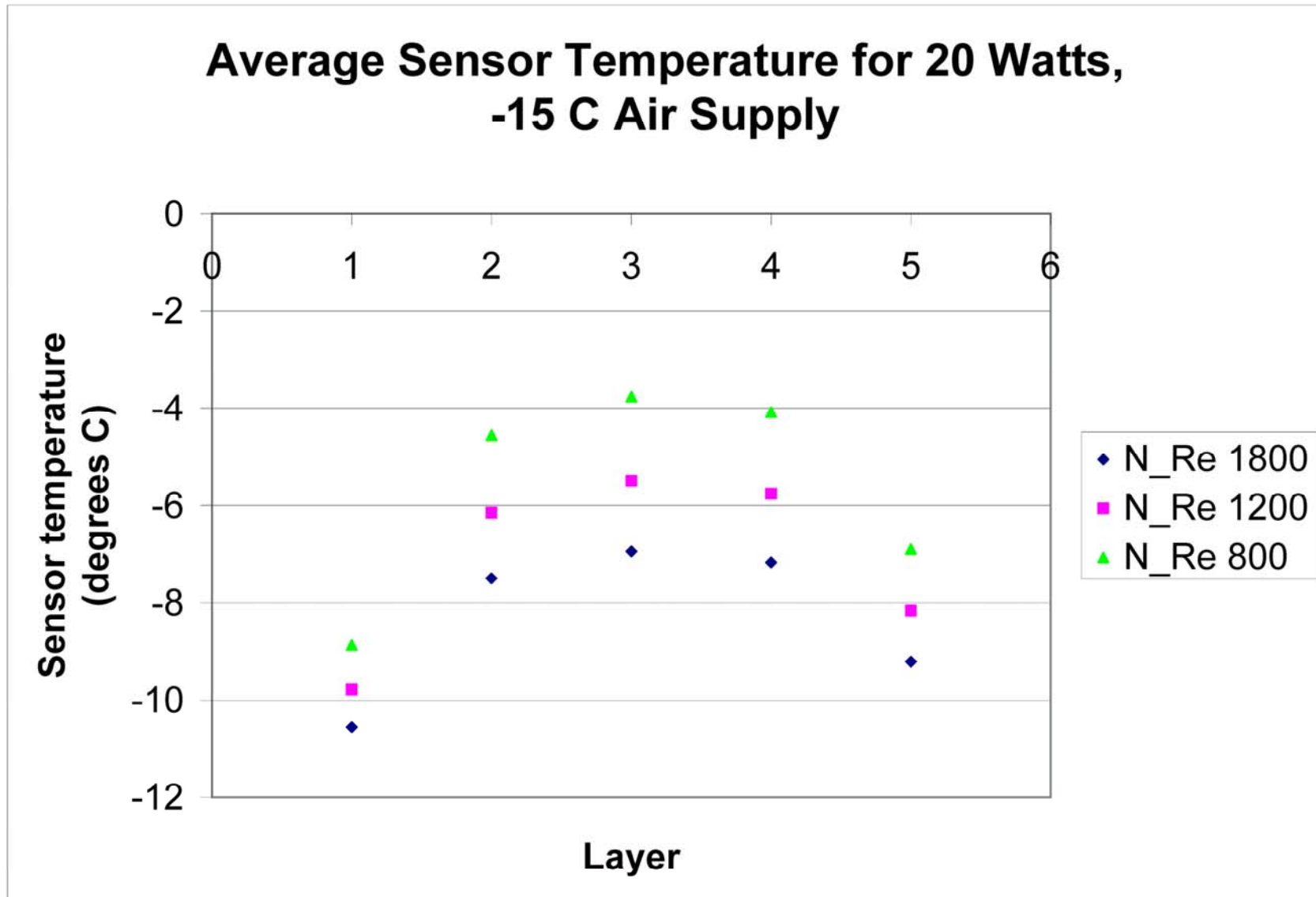



VXD Barrel Cooling

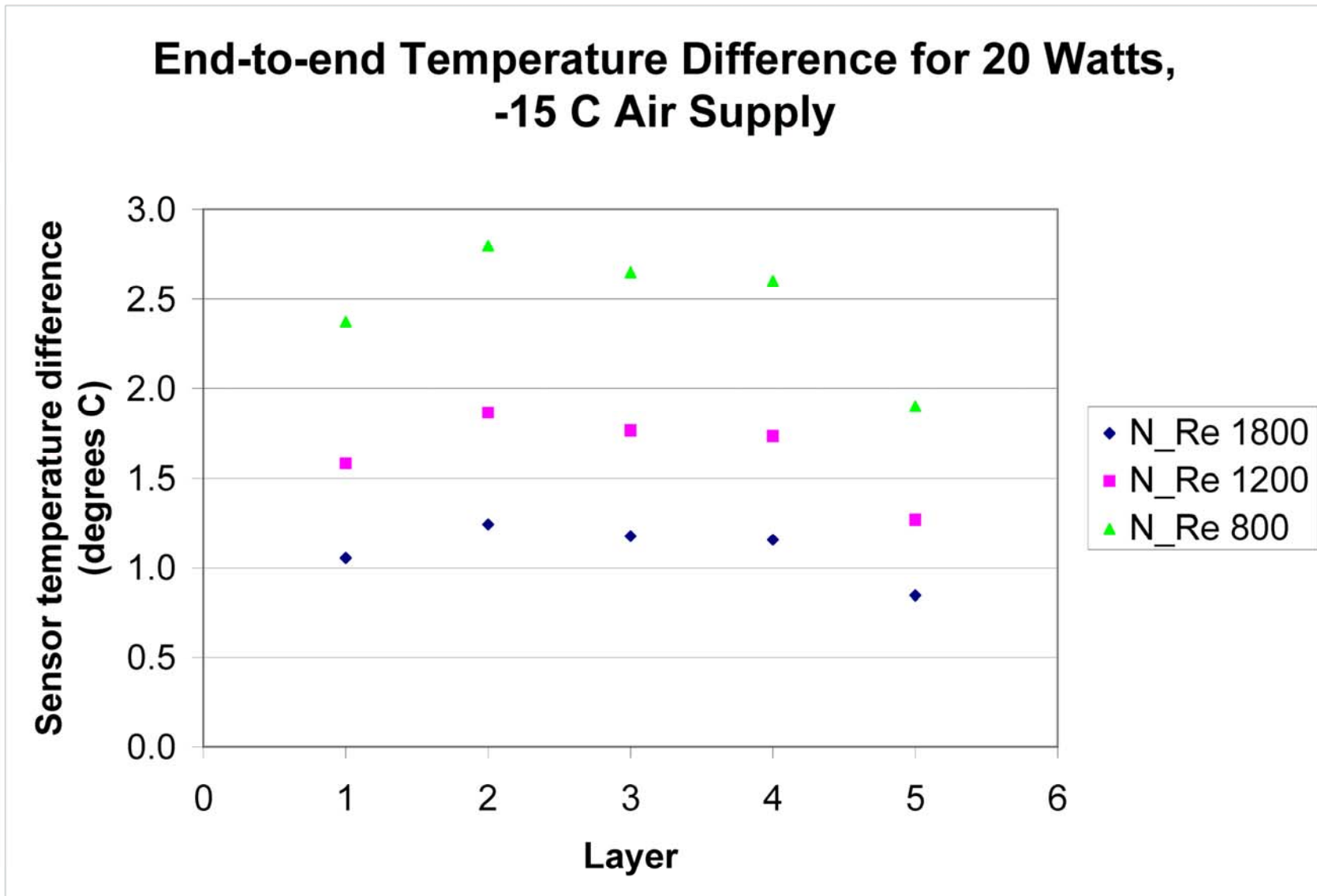



Comments

- Great interest in 3-D devices described by Ray Yarema. The methods described could apply to many of the sensor concepts.
- Considerable interest in ladders
 - Ladder R&D fits the resources of many facilities.
 - Time will tell how well ladders would work.
 - Effort seemed to be just beginning on ladder support within a barrel.
- Quite a few comments on the SiD design
 - Some issues to address, but no show-stoppers so far



Back-up Slides Follow



Detector Open / Full Access to Inner Detector

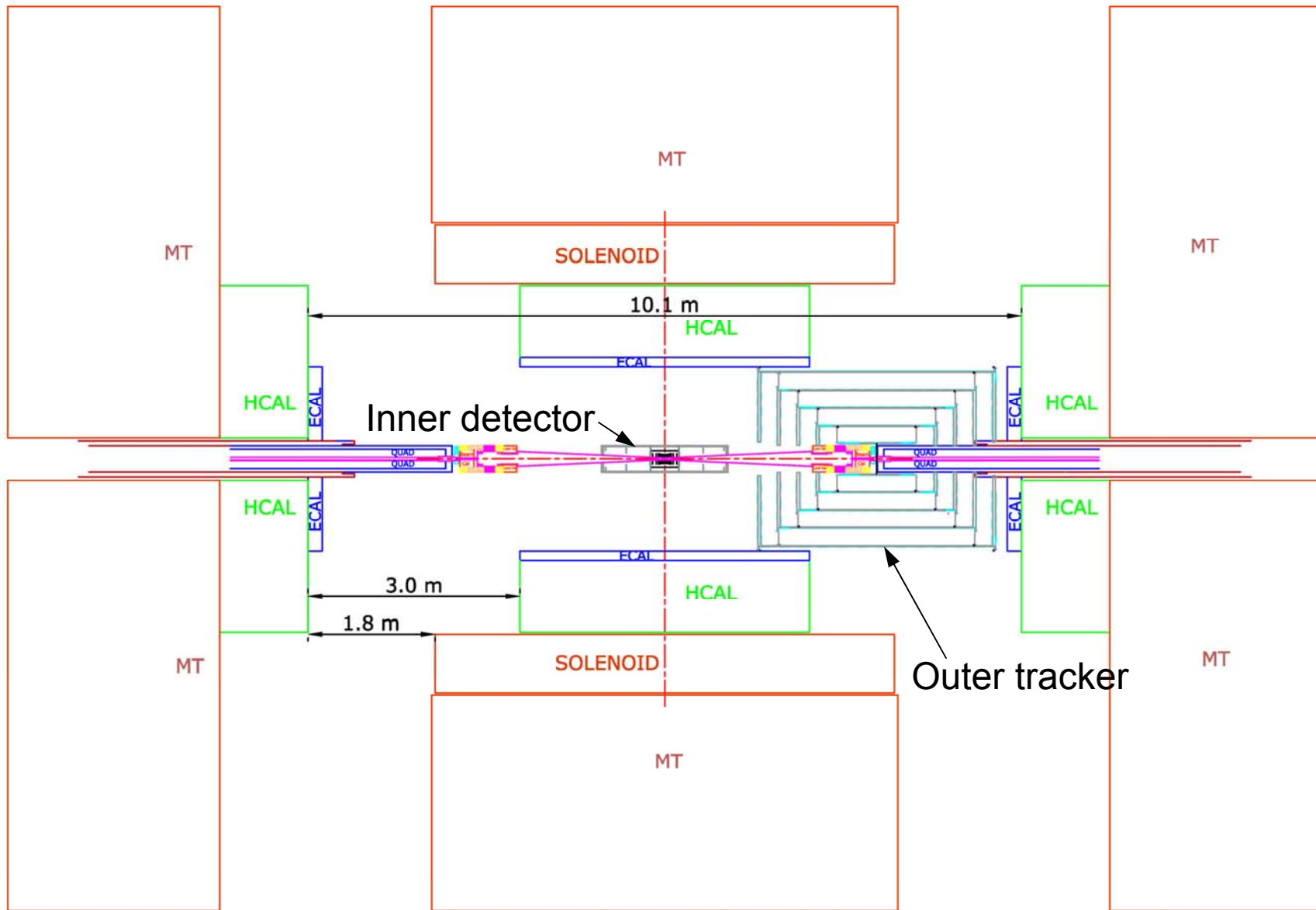



Silicon Tracking Layout (In Progress)

- Outer tracker (micro-strips)
 - 5 barrel layers
 - Measure R-Phi
 - 4 disks per end
 - OR = 1.25 m
 - IR = 0.2 m
 - Supported from ECAL
- Inner detector
 - VXD (pixels)
 - 5 barrel layers
 - 4 disks per end
 - Three additional “forward” disks extend angular coverage of the outer tracker to $\cos(\theta) = 0.99$
 - Supported from conical portions of beam pipe

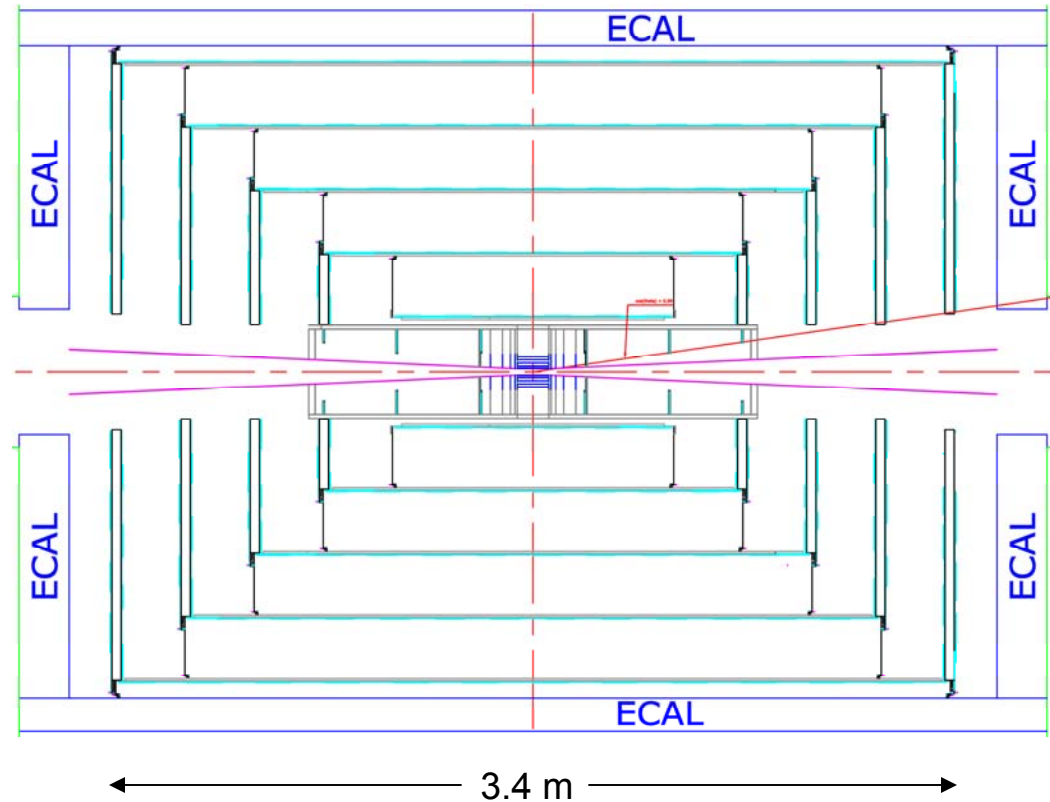

- Lengths of outer tracker barrels have been adjusted to reduce the extent to which material aligns with a ray from the origin.
- Outer tracker disks could be shallow cones to increase stiffness in Z while reducing material.



Tracking Philosophy

- Vertex detector
 - Provides high-precision measurements of tracks and vertices
 - $\sim 3 \mu\text{m}$ vertex resolution
 - Provides an initial measurement of momentum
- Outer silicon detector
 - Measures P_T
 - In combination with a track direction from the vertex detector, provides P
 - Connects tracks to calorimetry

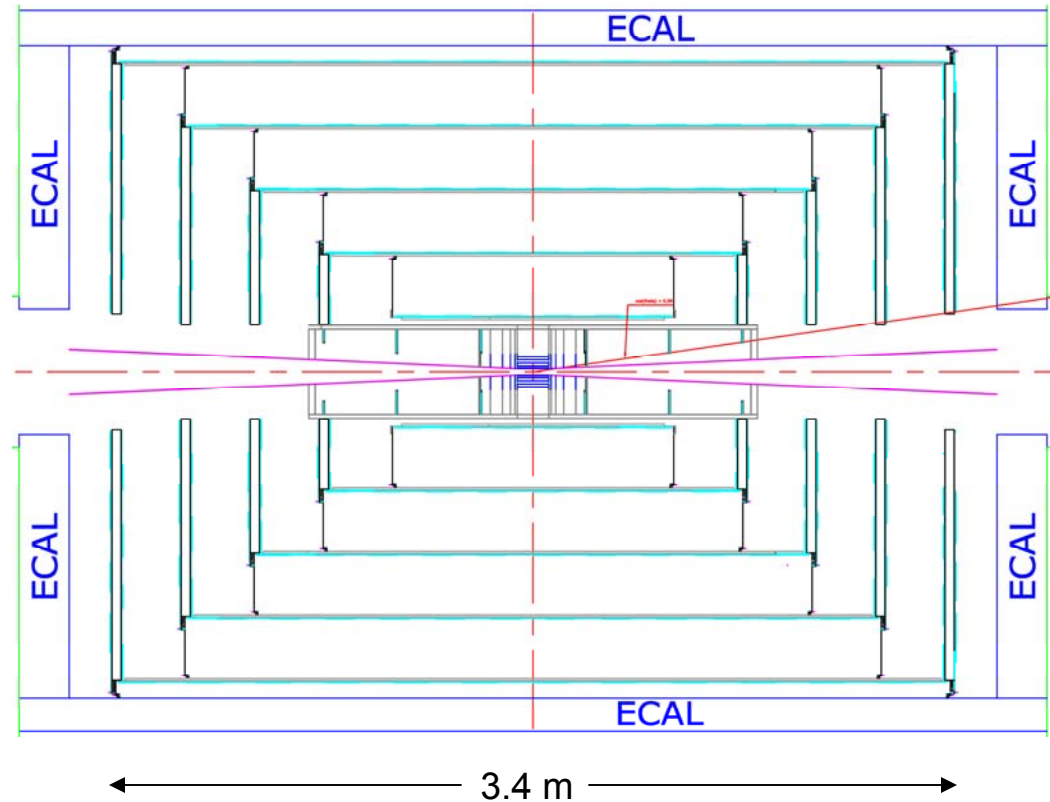

- Calorimetry
 - Measures E
 - PFA to improve resolution
 - Allows tracking backward into outer tracker



Tracking Philosophy

- Disks extend outer tracker and vertex detector coverage in forward and backward directions.
- Geometry has been chosen to provide full overlap for straight rays.

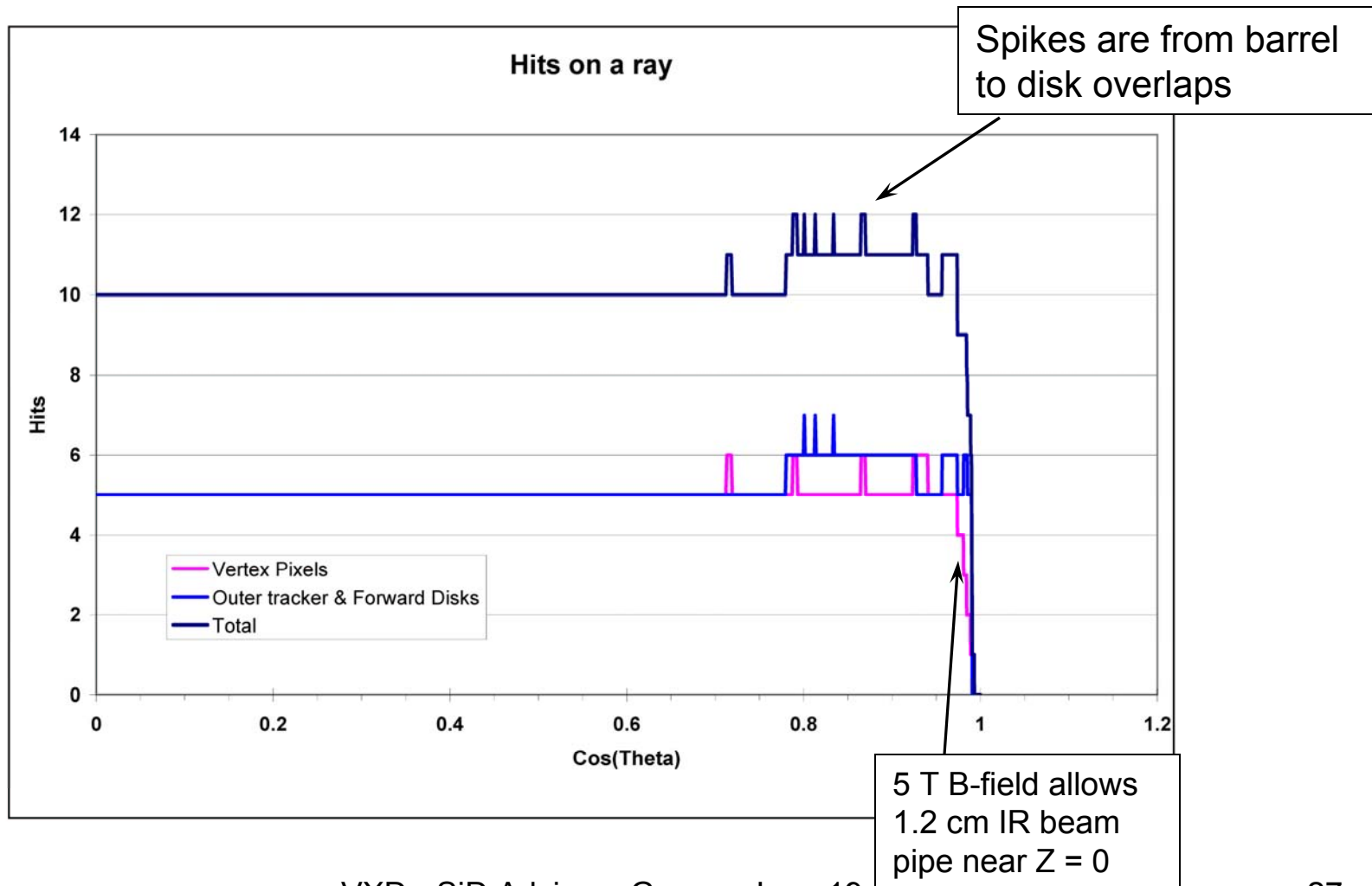



Tracking Philosophy

- Disks extend outer tracker and vertex detector coverage in forward and backward directions.
- Geometry has been chosen to provide full overlap for straight rays.

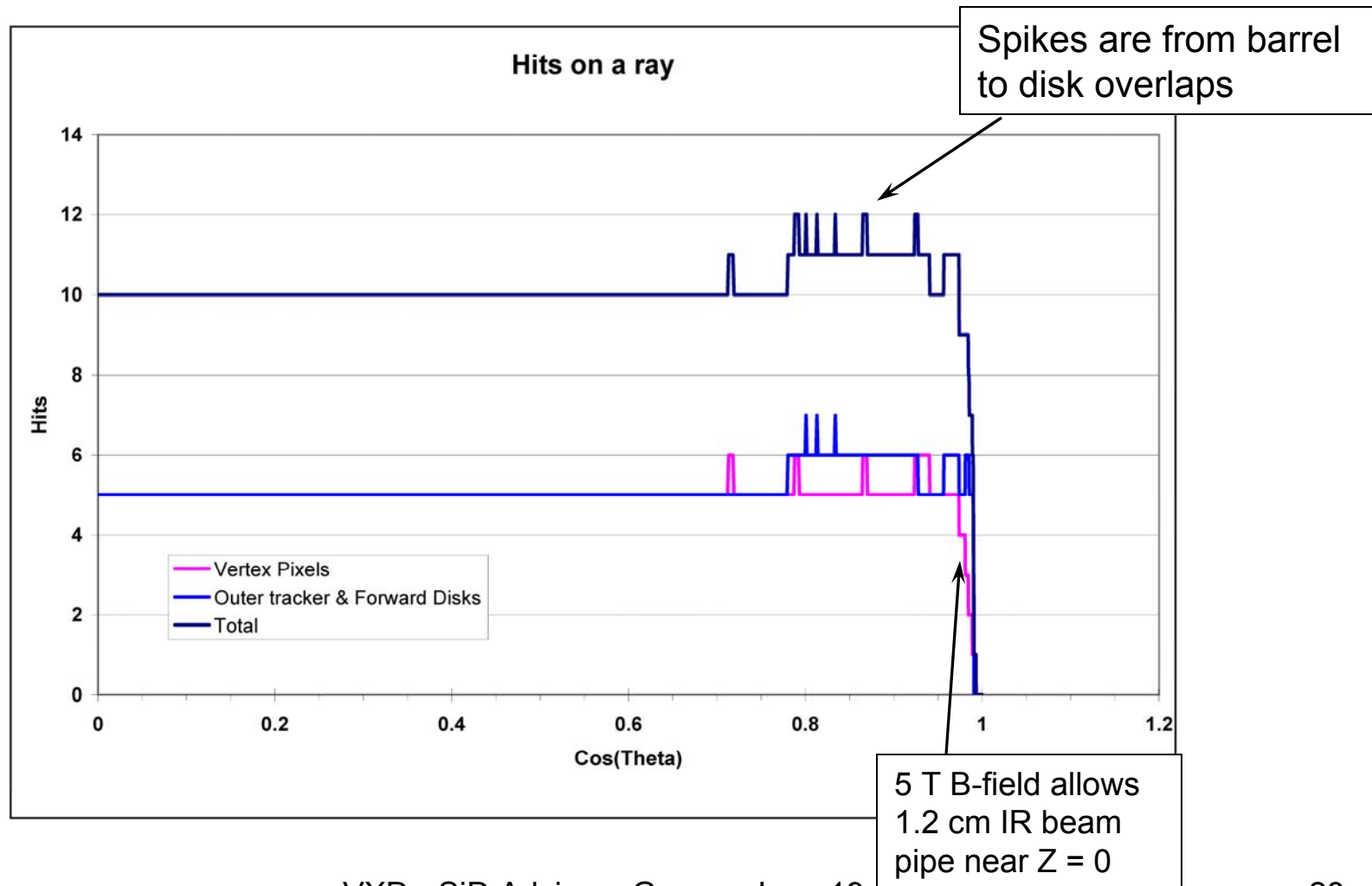

VXD Material

Su Dong, May 2006

- Assumptions (partial):
 - 100 μm sensor thickness
 - 50 μm epoxy
 - 260 μm CF with $\frac{3}{4}$ of area removed
 - 400 μm beam pipe wall (central region)
 - 25 μm Ti beam pipe liner

For more information, see <http://www-sid.slac.stanford.edu/vertexing/material/material-may06.htm>

Barrel layers only
 Barrels plus disks

VXD material summary

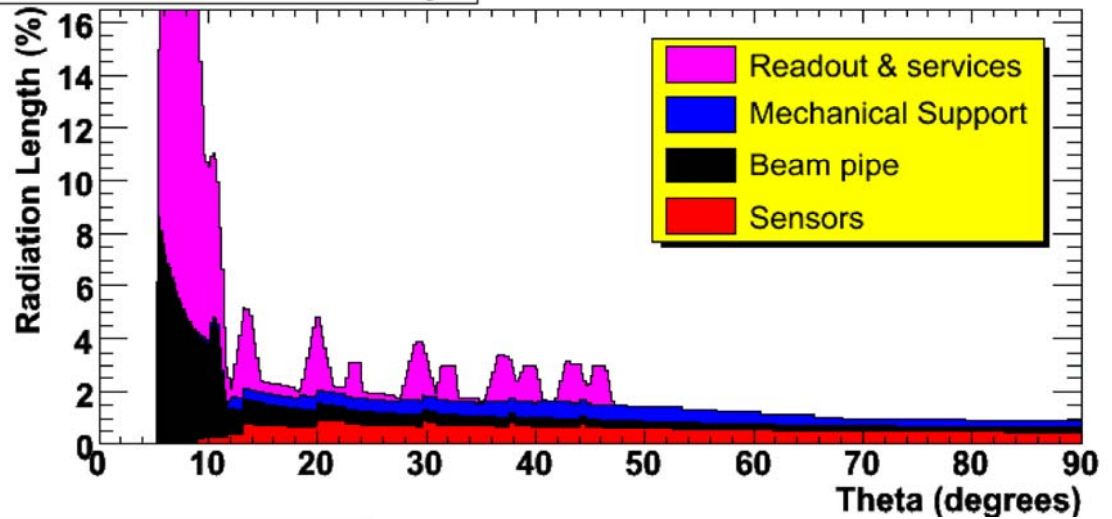

VXD hit coverage

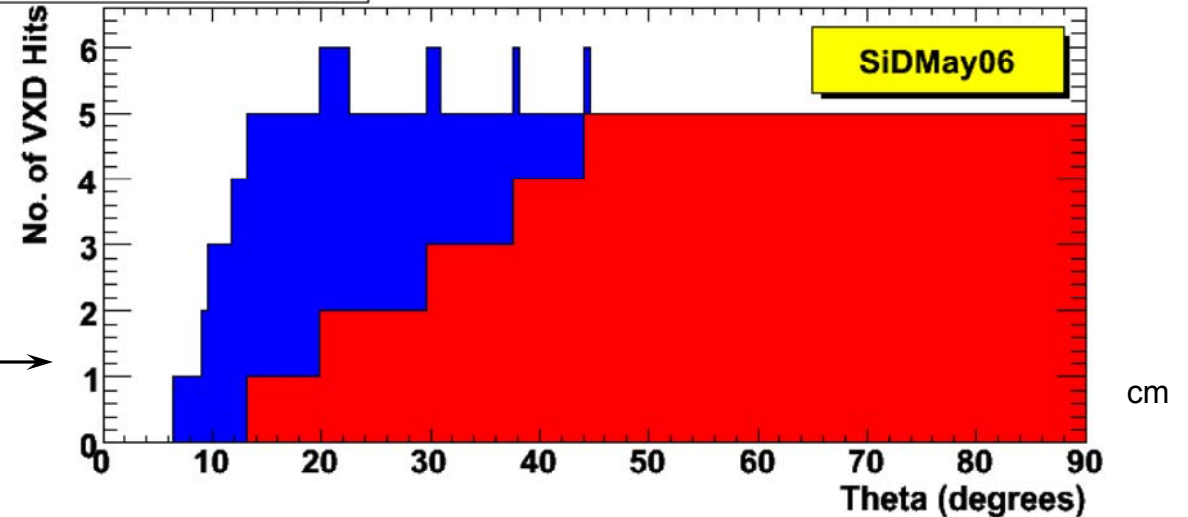



SiD VXD Barrel End View

- 2 types of sensors
- A and B sub-layer geometry
- 6-fold symmetry
- To reduce mass, barrel layers are glued to form a unit.
- Up to 15 sensors per unit

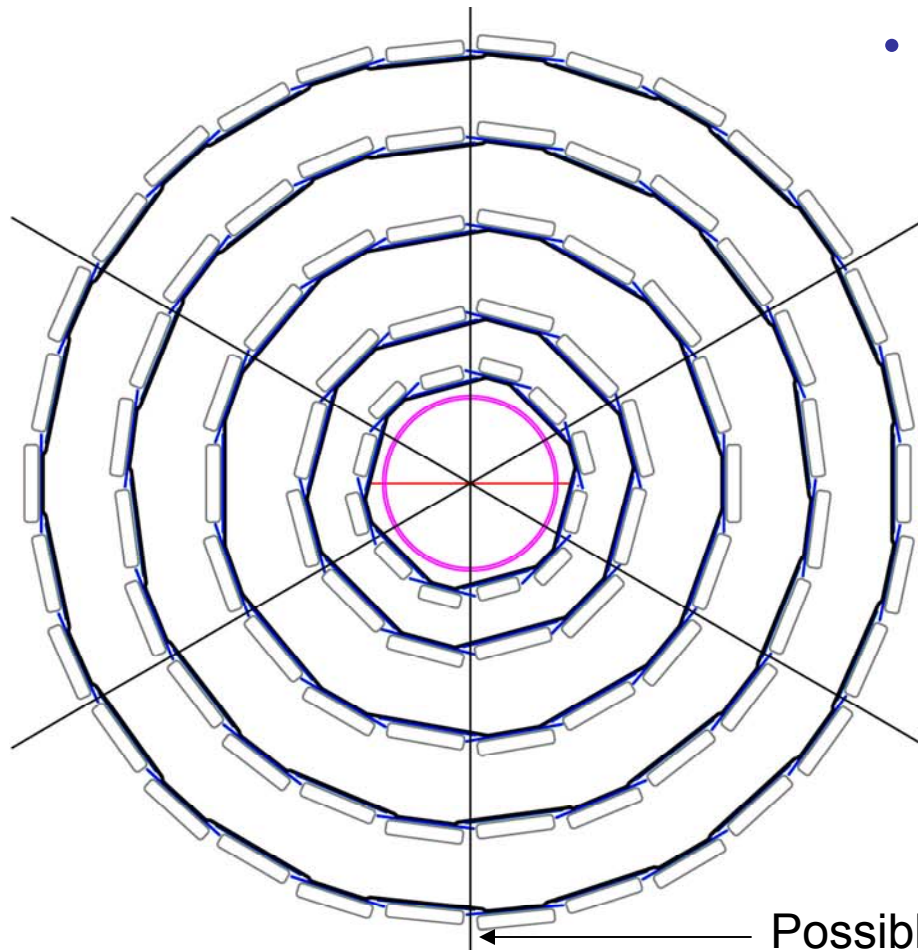

Sensors:

IR_A = 14, 22, 35, 47.6, 60 mm

IR_B = 15.15, 23.13, 35.89, 48.41, 60.77 mm

Active widths: 9.1, 13.3 mm

Cut widths: 9.6, 13.8 mm

Beam pipe IR: 12 mm

Beam pipe OR: 12.4 mm

March 3, 2006

Oblong boxes are openings in end rings and end membranes for cables, optical fibers, and air flow.

Splitting into two halves allows assembly about the beam pipe.

Possible clam-shell split line



VXD Barrel End View

- Control of “ladder” thickness allows barrel sensors to provide overlap to quite low momentum and to preserve good acceptance for tracks originating away from the beam line.

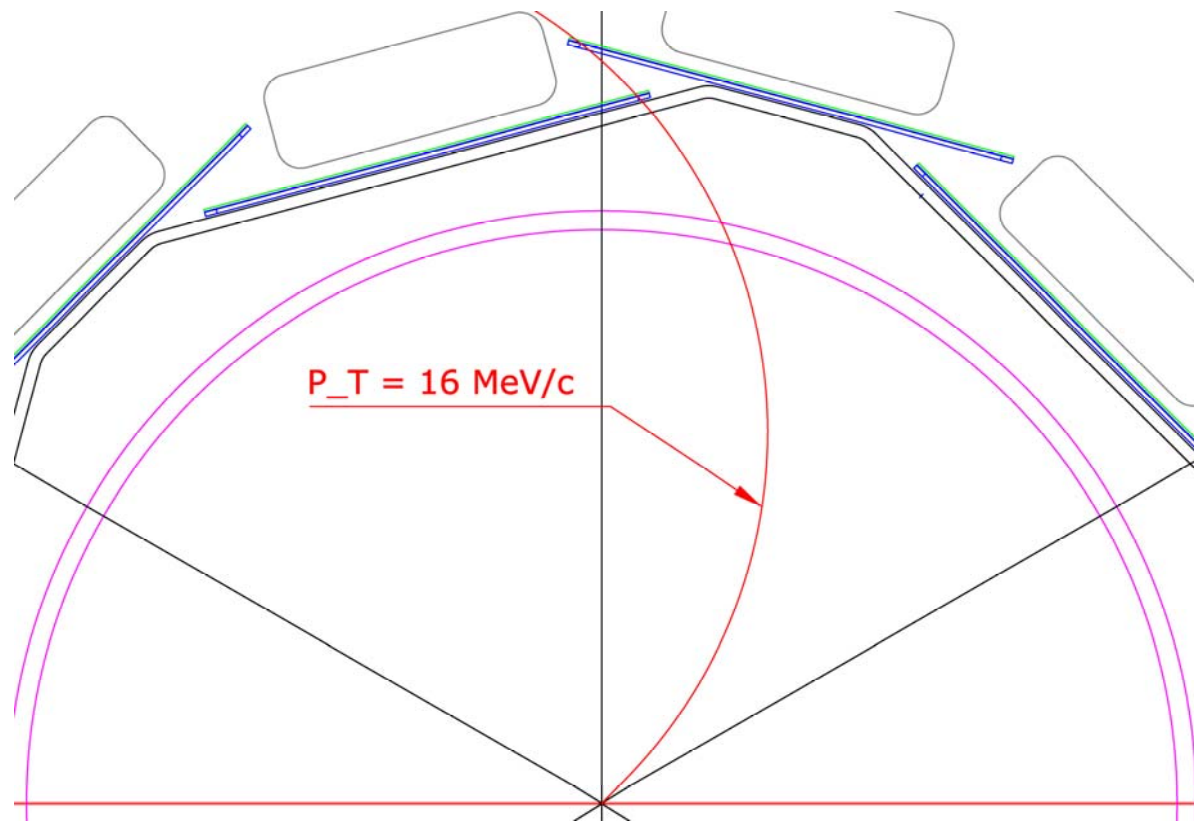



SiD VXD Elevation View

- Outer split cylinders couple to the beam tube at $Z = \pm 214$ and ± 882 mm, are supported by the beam tube, and stiffen it.
- High modulus CF has been assumed for most support structures.
 - Typical thickness, 0.26 mm, assumes 4 layers of pre-preg.
 - In many places, average thickness can be substantially reduced by cutting holes.
- CF membranes support the barrel and disks.

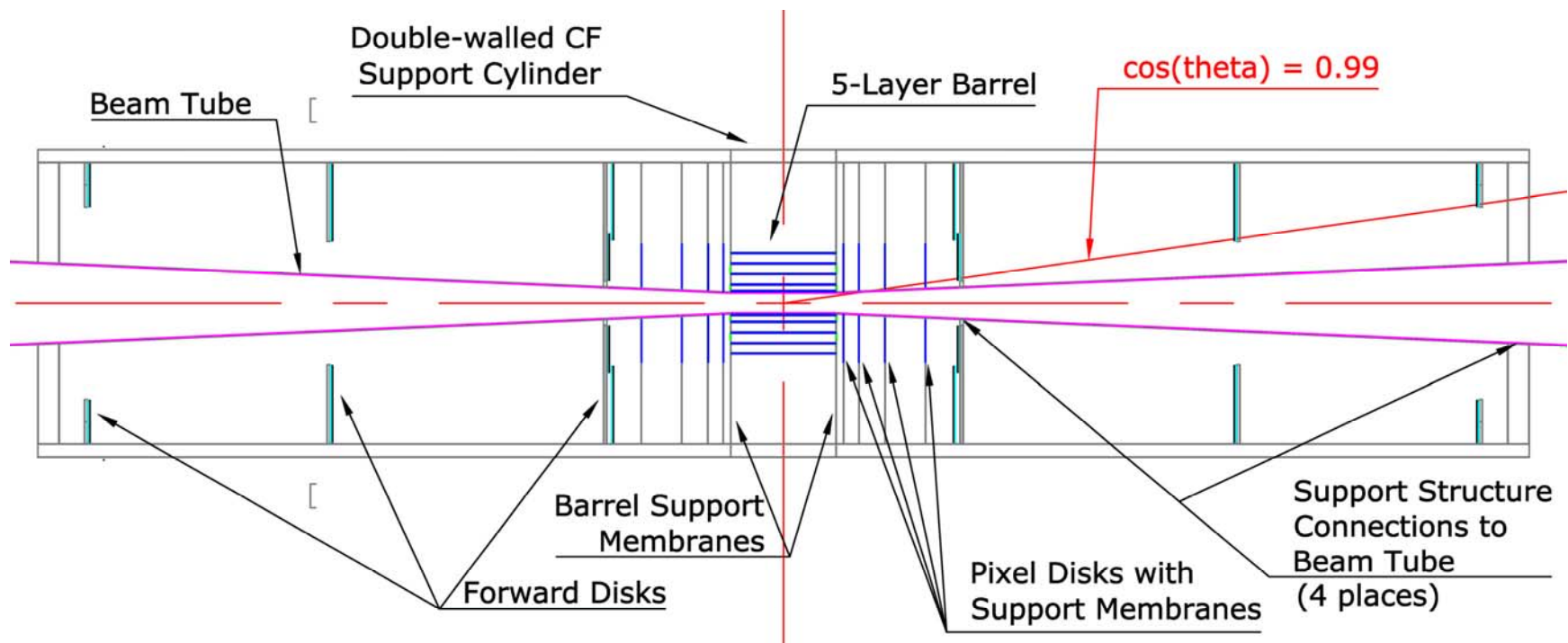



SiD Sensor Assumptions

- VXD pixel size = $20\ \mu\text{m} \times 20\ \mu\text{m} \times 20\ \mu\text{m}$ (or less) in the central pixel region
 - Provides good resolution and pattern recognition with five layers
 - Forward disks may have a coarser granularity
- Sensors are cooled by forced flow of dry gas.
 - Limits the number of radiation lengths
- To minimize Phi gaps between sensors, we assumed the following.
 - Sensor boundaries about active area are 0.25 mm wide.
 - Sensor thickness, including readout, is 0.15 mm.
 - The gap from the physical edge of one sensor to the surface of the next is 0.5 mm.
 - Of the 0.5 mm, we think 0.25 mm is needed. Portions of sensors could extend into the other 0.25 mm.
- To eliminate the need for barrel sensor-sensor longitudinal overlap, we assumed 125 mm long sensors (6" technology).
- We assumed that sensors are flat as fabricated and do not need to be flattened by support structures.



SiD Sensor Assumptions

- To allow low-mass support with dry air cooling, we assumed a sensor operating temperature $> -10^{\circ}$ C.
 - Reduces thermal expansion issues with carbon fiber support structures
 - Reduces thermal insulation requirements
- For an initial cooling study, we assumed that average power dissipation of central pixel sensors = $131 \mu\text{W}/\text{mm}^2$ and that power is uniformly distributed over a sensor.
 - Given present technologies, that implies power is ramped.
 - It allows reasonable sensor temperatures with laminar air flow.
 - Laminar flow minimizes the likelihood of flow-induced vibration.
 - In the forward disks, where pixels may be a factor of 4 larger in area, we assumed $33 \mu\text{W}/\text{mm}^2$.
- We would expect to modify sensor assumptions to match sensor developments.

Barrel Layers

- Sensors are supported from and glued to a carbon fiber (CF) shell.
- Each barrel layer includes a CF end ring, which controls out-of-round distortions.
- Openings provide cable, optical fiber, and dry gas passages.
- Other openings to reduce mass and adjust gas flow would be added.
- End membranes connect one layer to the next to form a half-barrel.
- To control material, the use of fasteners has been limited.
 - Three fasteners per end ring

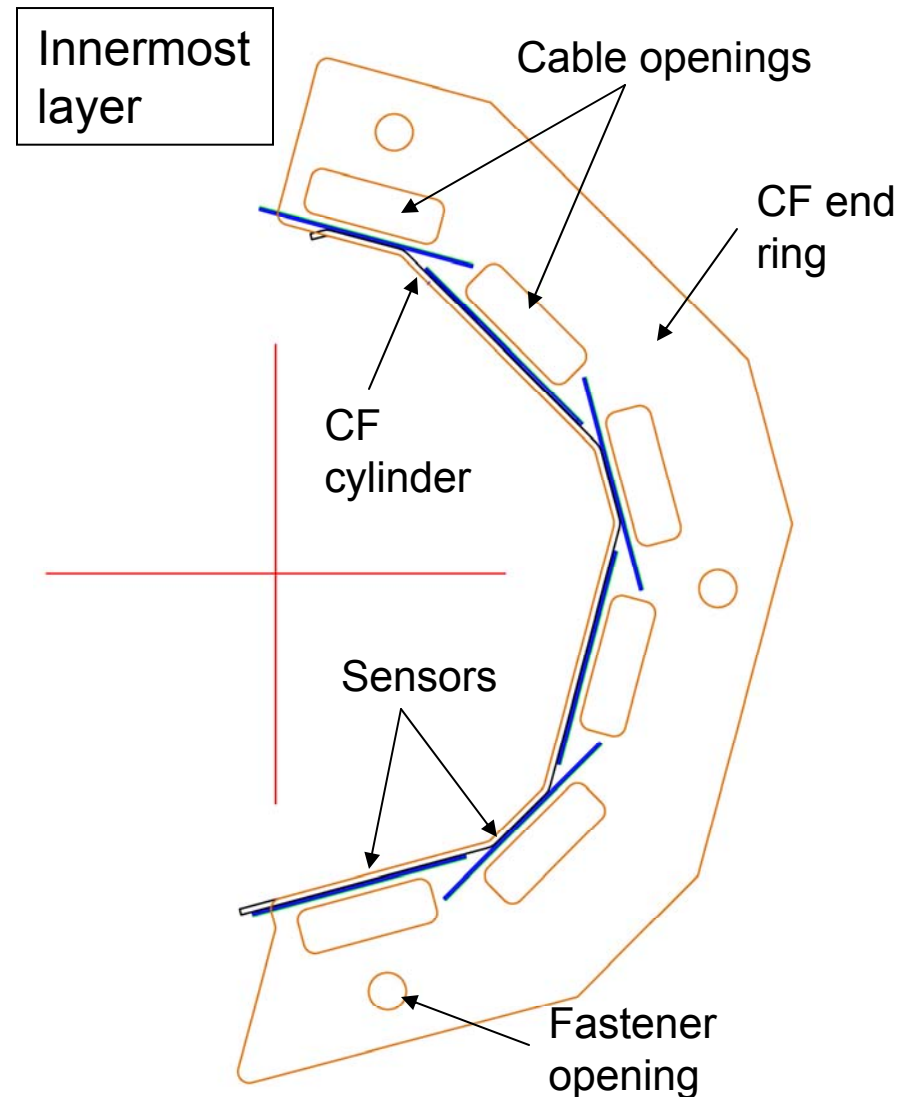



Disk Cooling and Manifolding

- Sensors of the four disks per end closest to the barrel were assumed to have the same power dissipation per unit area as barrel sensors, $131 \mu\text{W}/\text{mm}^2$. For eight disks (both ends), power dissipation would be 17 watts.
- Two options were considered for the three outermost disks per end.
 - Pixels twice the size in each transverse dimension as those of the barrels, so $\frac{1}{4}$ the power per unit area. Total power dissipation (both ends) = 13 watts.
 - Pairs of silicon micro-strips. Total power dissipation (both ends) = 7 watts.
 - We assumed the larger of the two values, 13 watts.
- To size manifolding to deliver and distribute air, we assumed power dissipation of the barrel and all disks would total 50 watts.
- One obvious possibility is to distribute air via the outer support cylinder. For a 15 mm wall separation, nearly the full circumference is needed to maintain laminar flow. (The Reynold's number in portions seeing full flow = 1900). We assumed air entered support cylinder passages at a temperature of -20°C .



Barrel Support

- We know how to fabricate and predict the behavior of this type of CF structure.
- Silicon Layer 0, recently installed at Fermilab in the D0 experiment, relies upon CF support structures of the same material and similar geometry.
 - More complex design
 - Overall length = 1.66 m
 - Sensor centerline radii = 16.22, 17.81 mm
 - Two nested cylinders
 - 5 plies in the outer cylinder
 - 3 plies in the inner cylinder (the same as proposed)



Barrel Support

- Comparable in radius to VXD inner layer but much longer
 - 12-sided inner cylinder
 - 6-sided outer cylinder of more complex geometry
 - Imbedded triangular, PEEK cooling tubes
 - Greater length led to the use of nested cylinders
- We've begun discussing techniques to fabricate short cylinders and to remove (or omit) unwanted material

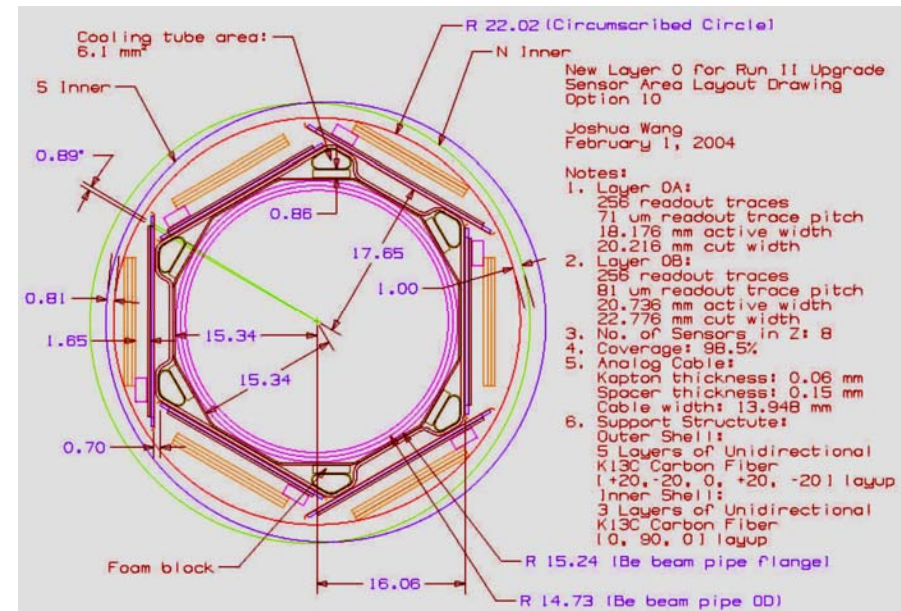



MPI Ladder

- We were asked if we would look at deflections and make a thermal analysis of an MPI ladder. Thermal analysis remains to be done.

Module Concept: "all-silicon module"

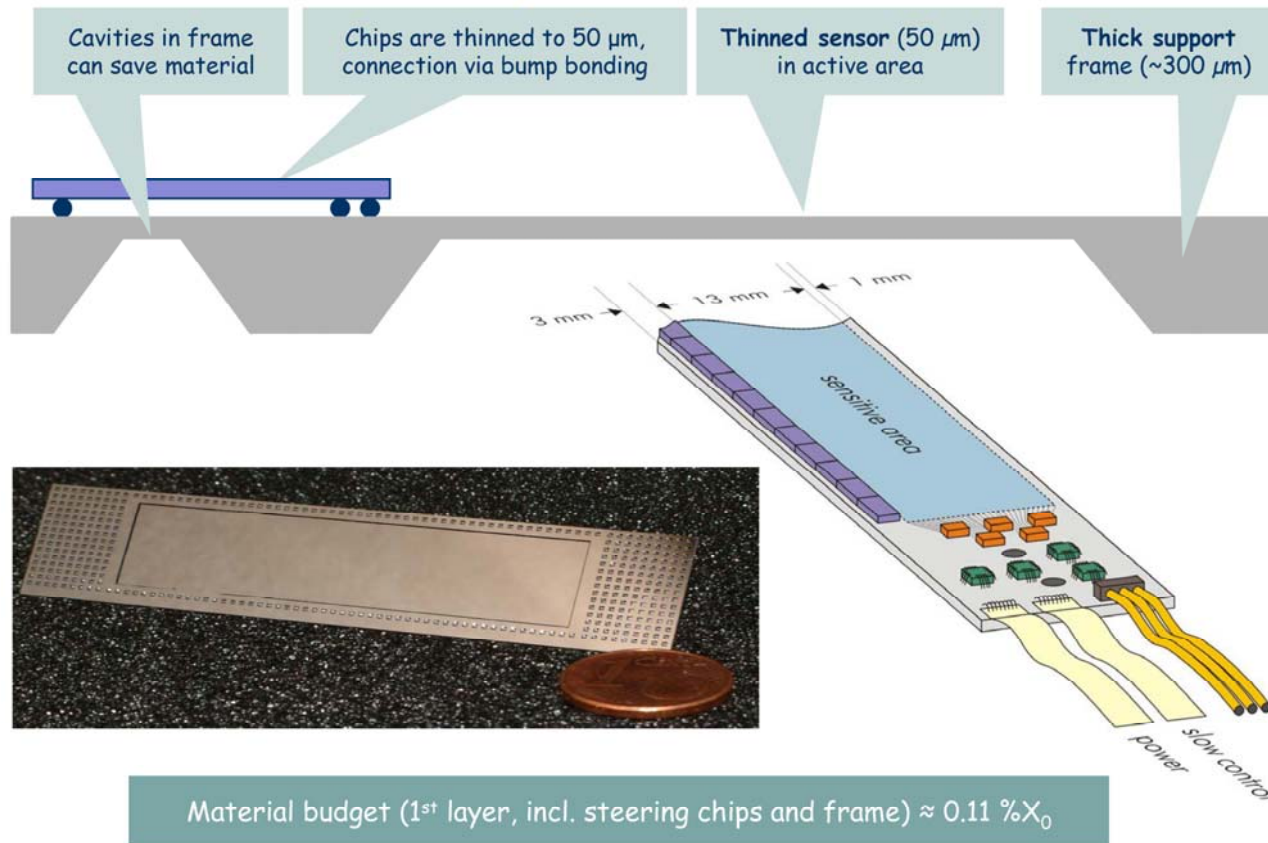

Ladislav Andricek MPI Halbleiterlabor



MPI Ladder

- Ladder was modeled as a window frame 3 mm wide on three edges and 1 mm wide on one long edge plus a thinner portion within frame.
 - Frame thickness = 0.3 mm
 - Thickness within frame = 0.05 mm
 - Overall length = 125 mm

FEA by C. H. Daly

All silicon

Hand calculation gave 77 μm

E_{silicon} was taken to be 110 GPa

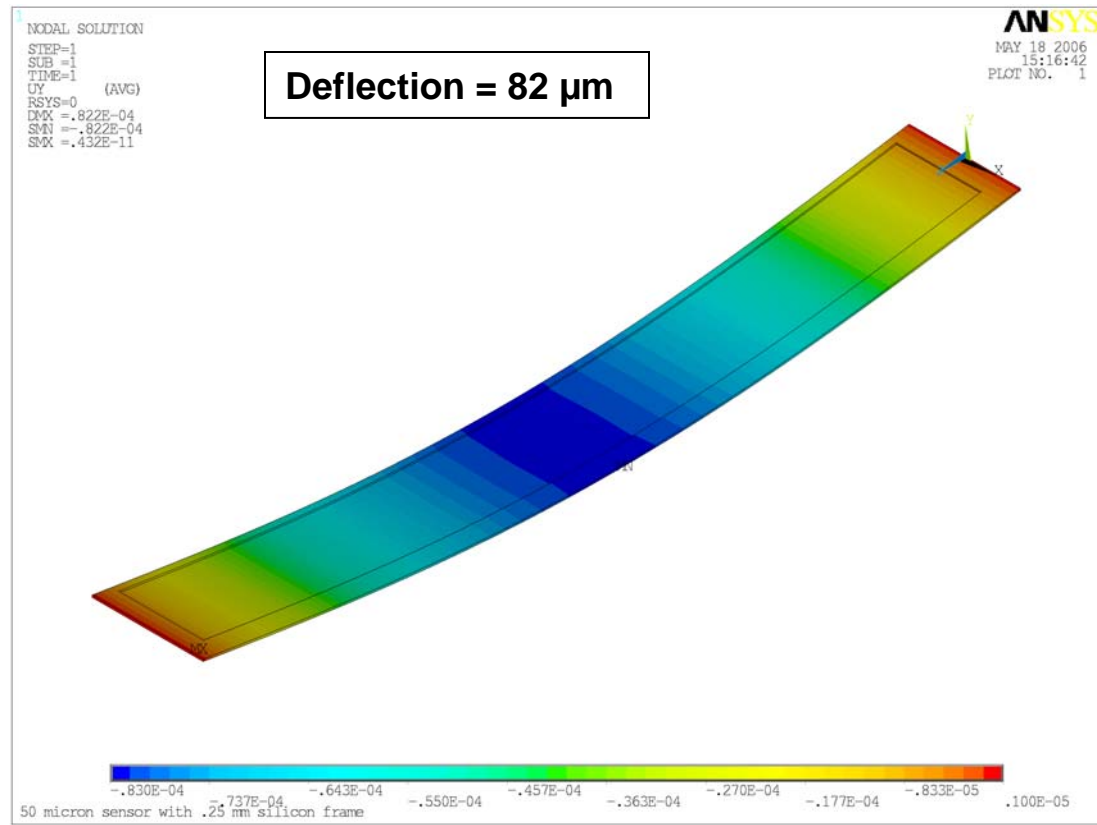



MPI Ladder

- 0.25 mm of frame thickness was replaced by CF, leaving 0.05 mm silicon thickness over the full extent of the ladder.
- I'll come back to these deflections later.

FEA by C. H. Daly

Silicon + CF

Hand calculation gave 46 μm

E_{CF} was taken to be 228 GPa

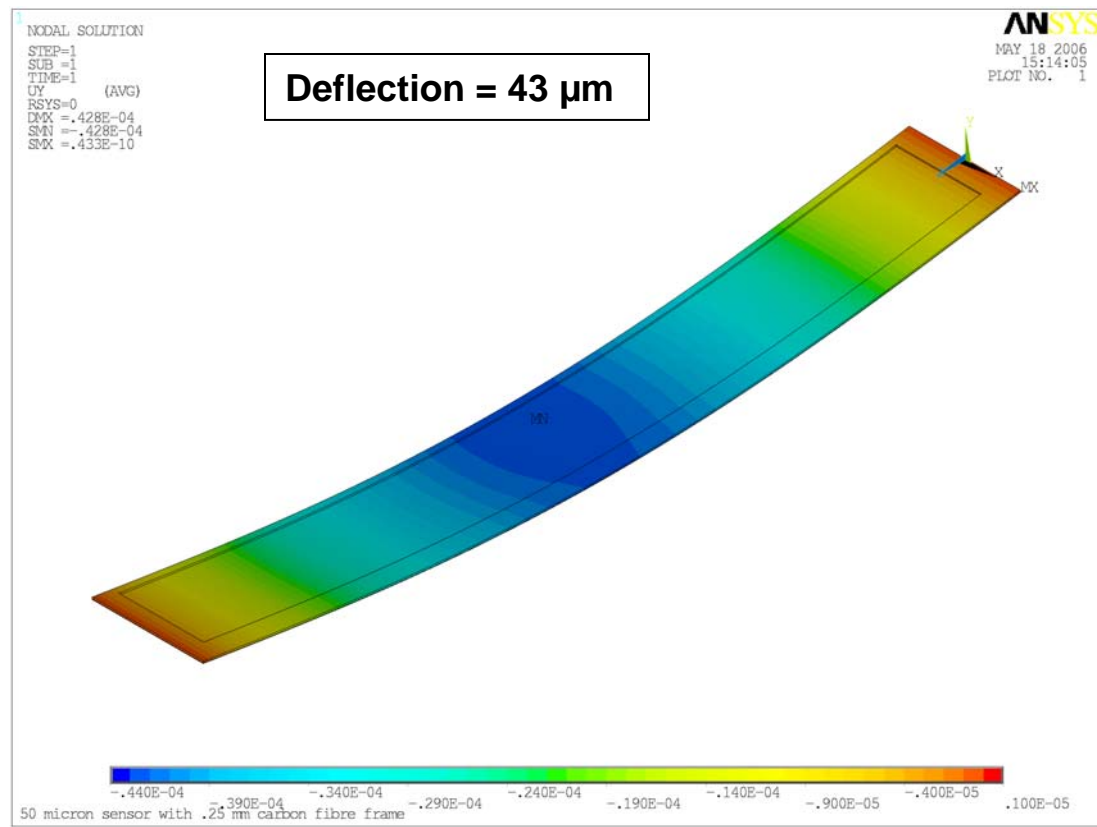



More on MPI Ladder Deflections

- An obvious fix to reduce deflections of single ladders is to glue ladders to one another to form half-cylinders.
- Sensor widths still need to be adjusted to give good overlap.
- We need to look at end membrane connections.
- My educated guess is that deflection would be $< 6 \mu\text{m}$ over a length of 125 mm.

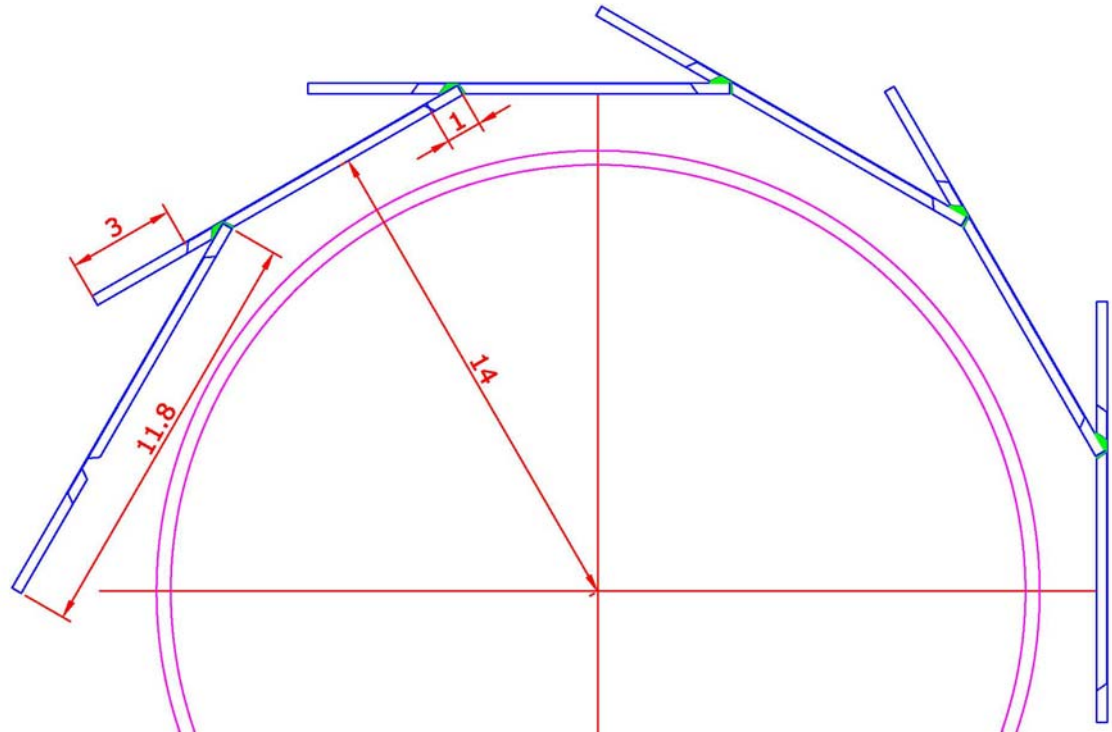

Innermost layer assuming spiral geometry & SiD beam pipe