

T2K TPC resistive prototype test at CERN

Paul Colas

ZY Projection

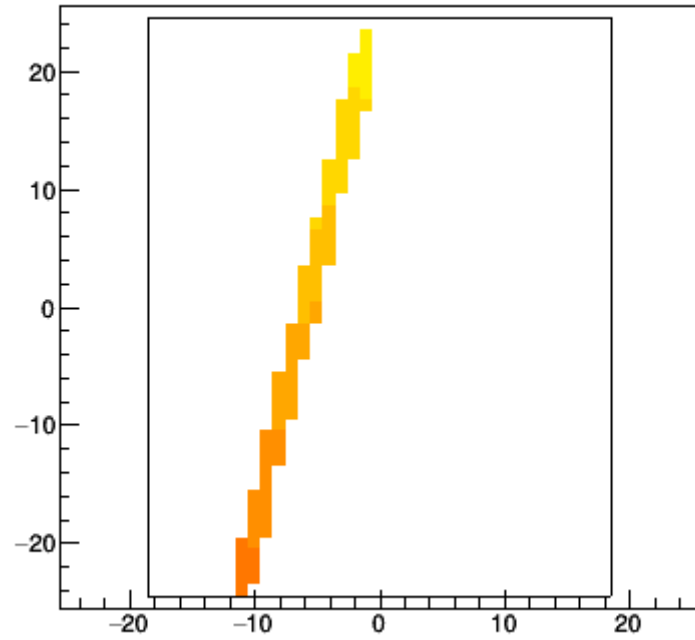

ZT Projection

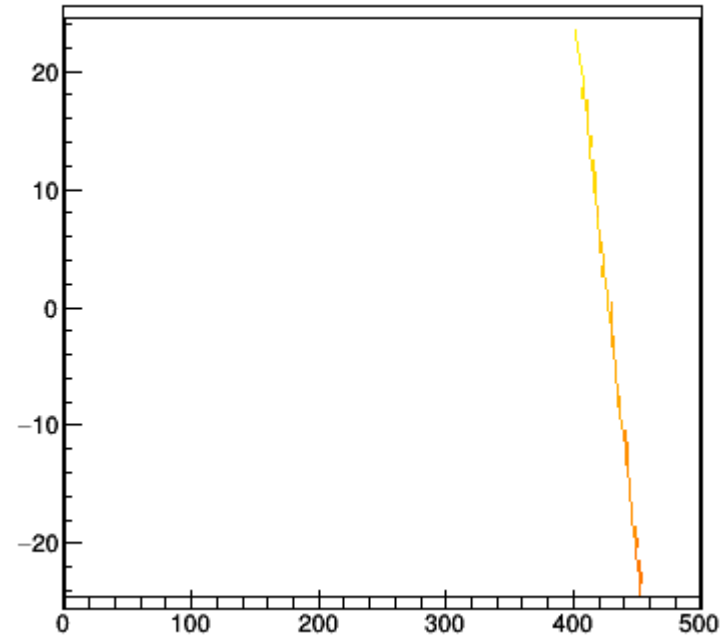

ZY Projection

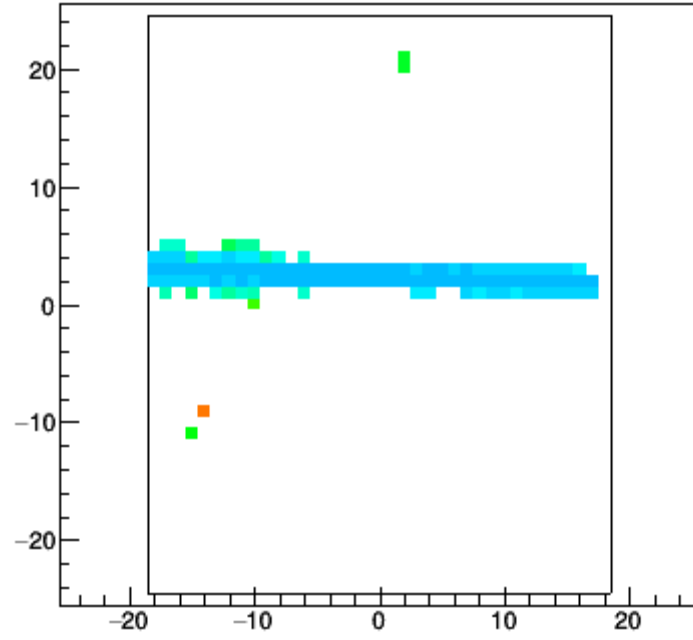

ZT Projection

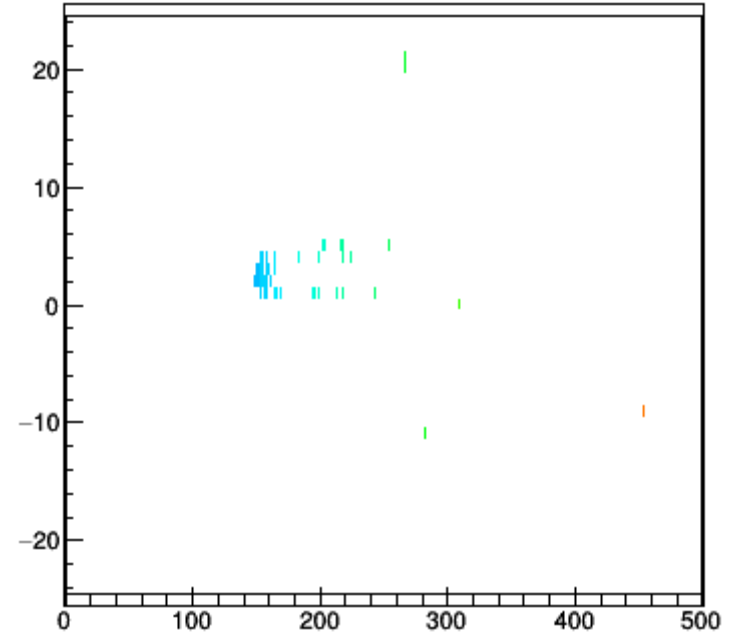

Node 0 KEY 1347

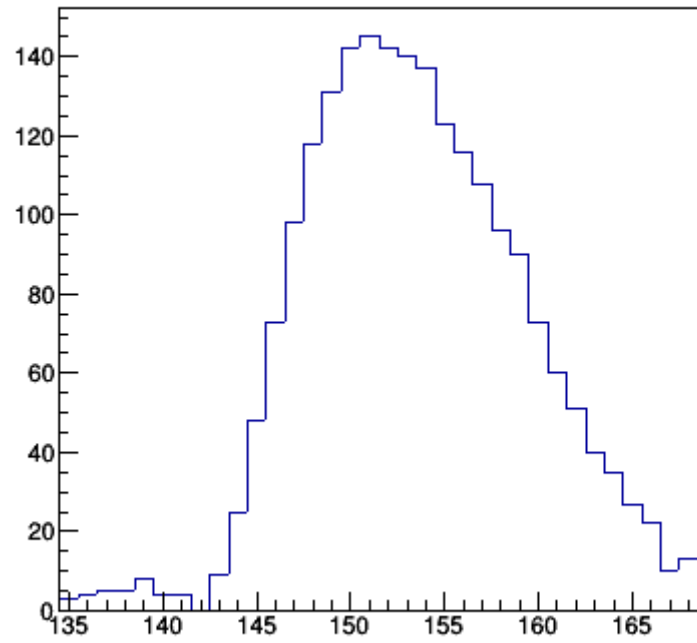

Node 0 KEY 1353

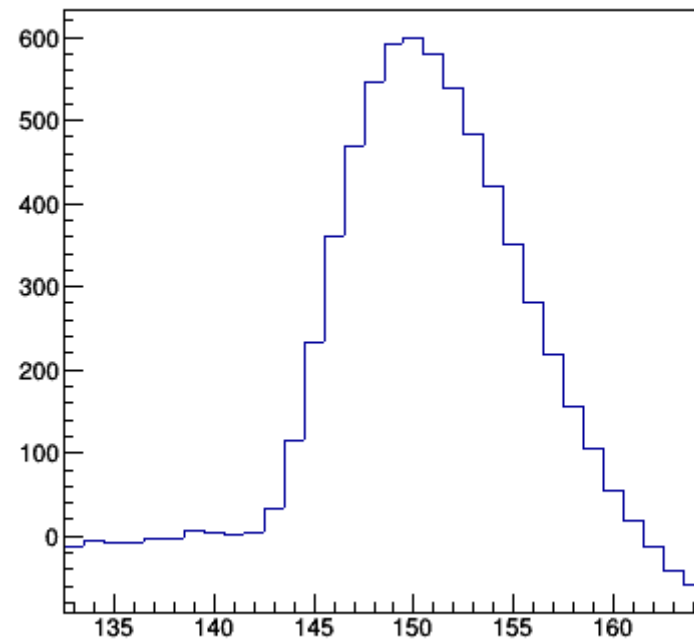

Node 0 KEY 1359

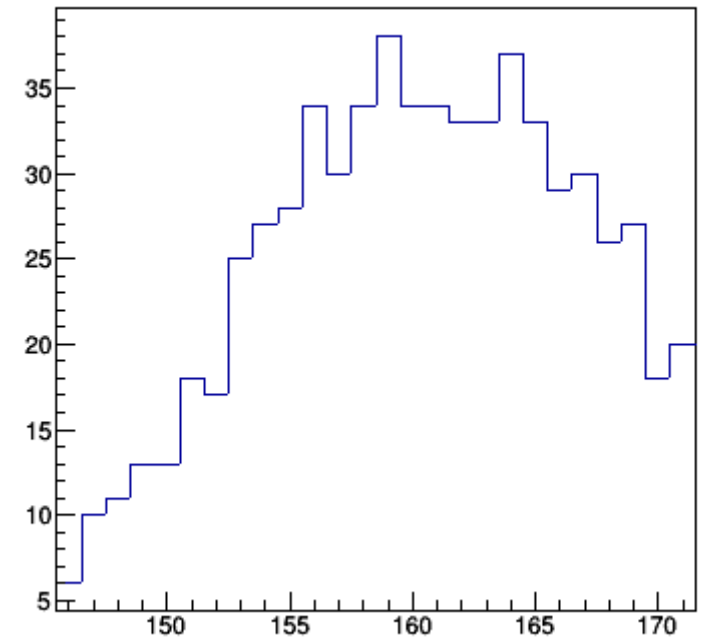

ZY Projection

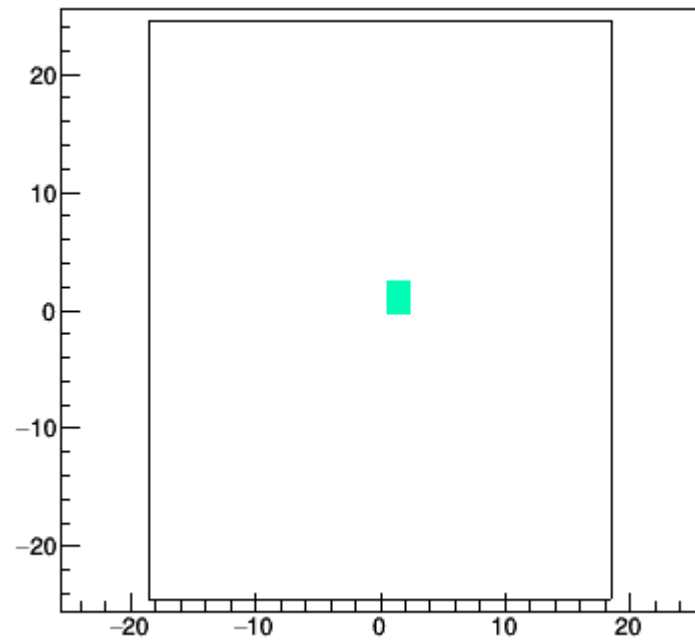

Node 0 KEY 1069

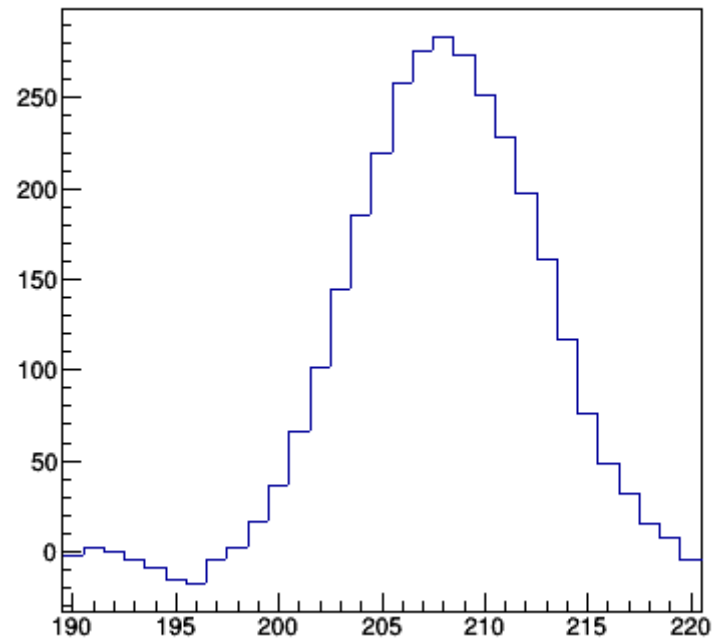

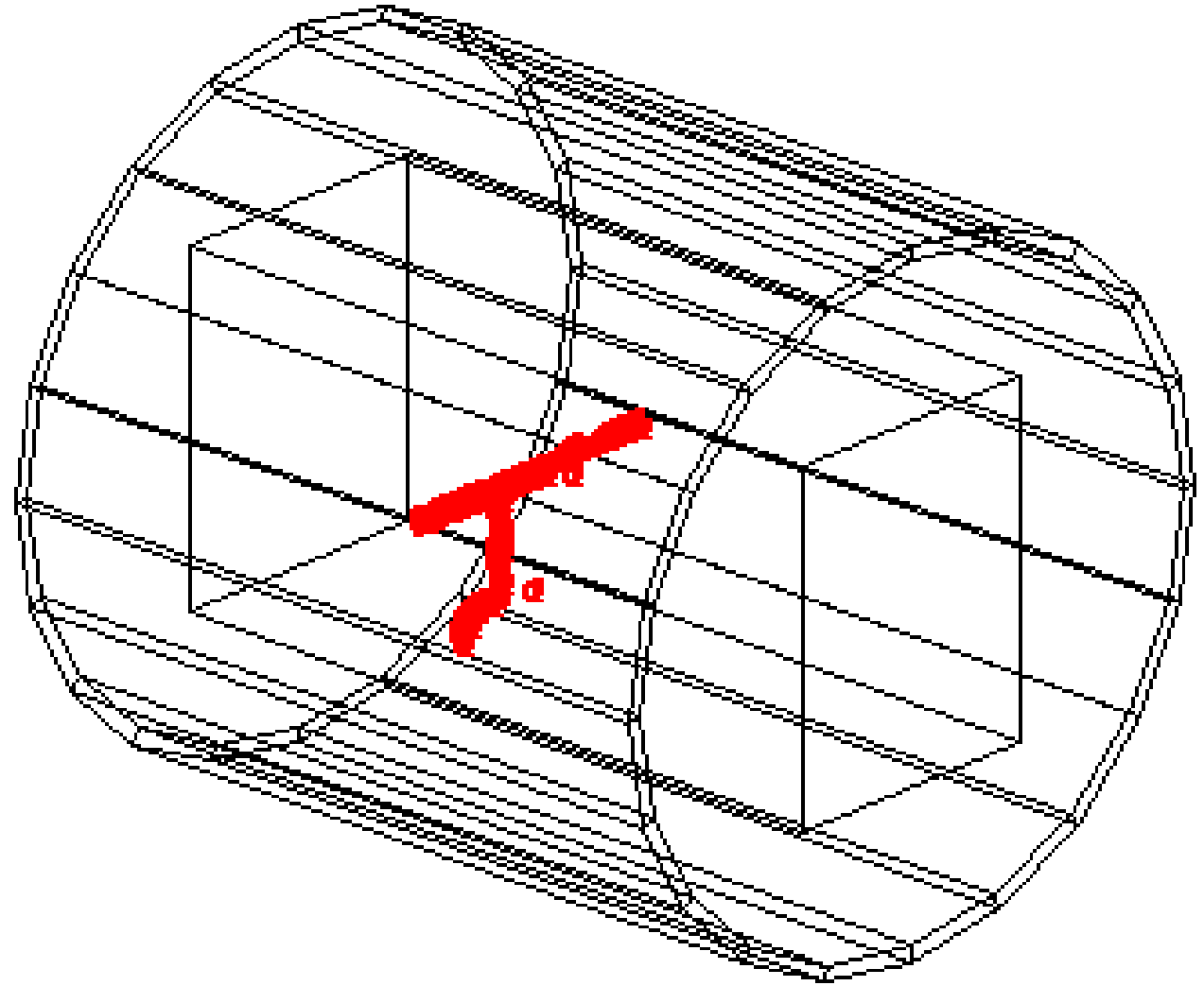

ZY Projection

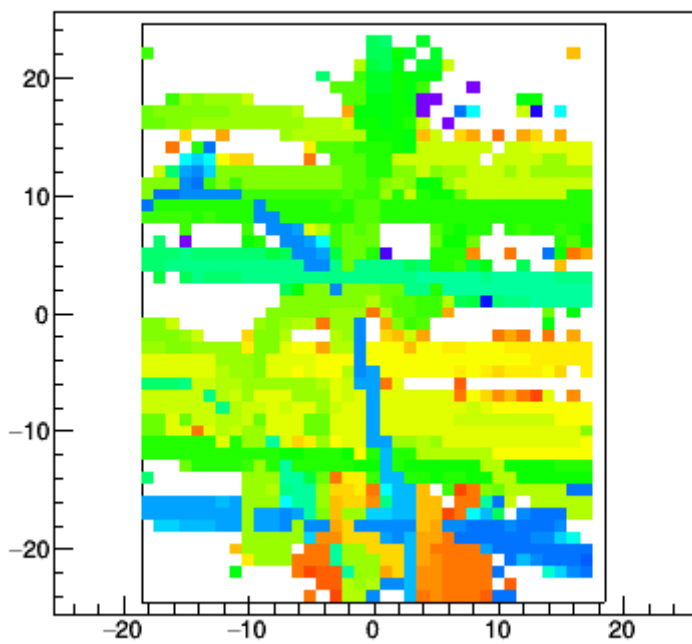

YT Projection

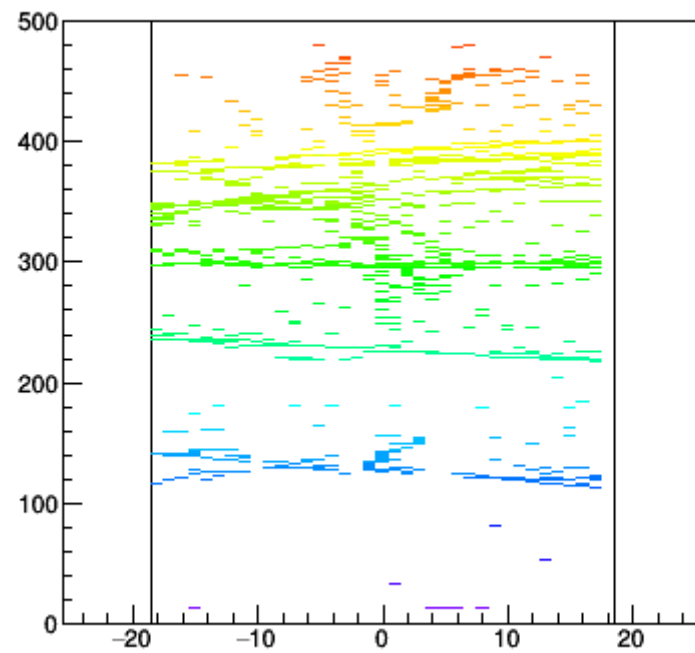

Node 0 KEY 608

