

Study on Saturation of SiPM using UV laser

Naoki Tsuji, The University of Tokyo

Linghui Liu, Wataru Ootani, Kosuke Yoshioka, Makoto Gonokami, Yusuke Morita

LCWS2019 at Sendai, 28/Oct./2019 - 1/Nov./2019

Sc-ECAL

- Scintillator Electromagnetic CALorimeter (Sc-ECAL)
 - Technology option of EM calorimeter for ILD
- Based on scintillator strips readout by MPPC
 - $5 \times 45 \times 2 \text{ mm}^3$ scintillator strip
- Virtual segmentation : $5\text{mm} \times 5\text{mm}$ with strips in x-y configuration
- Timing resolution $< 1 \text{ ns}$
- Low cost

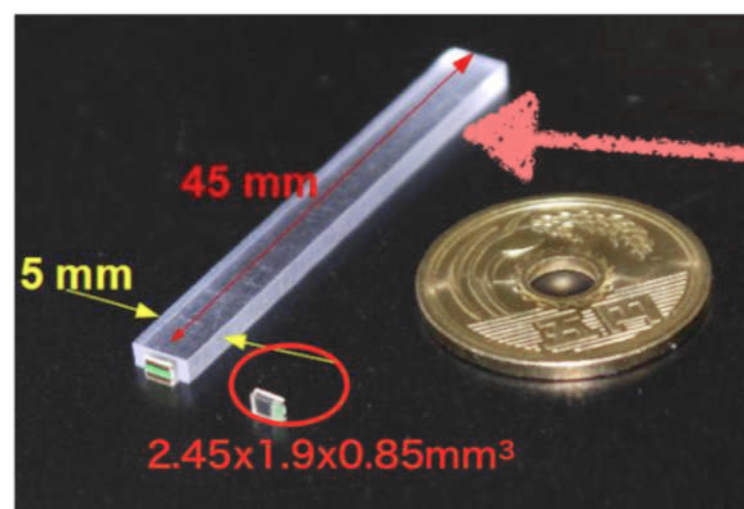
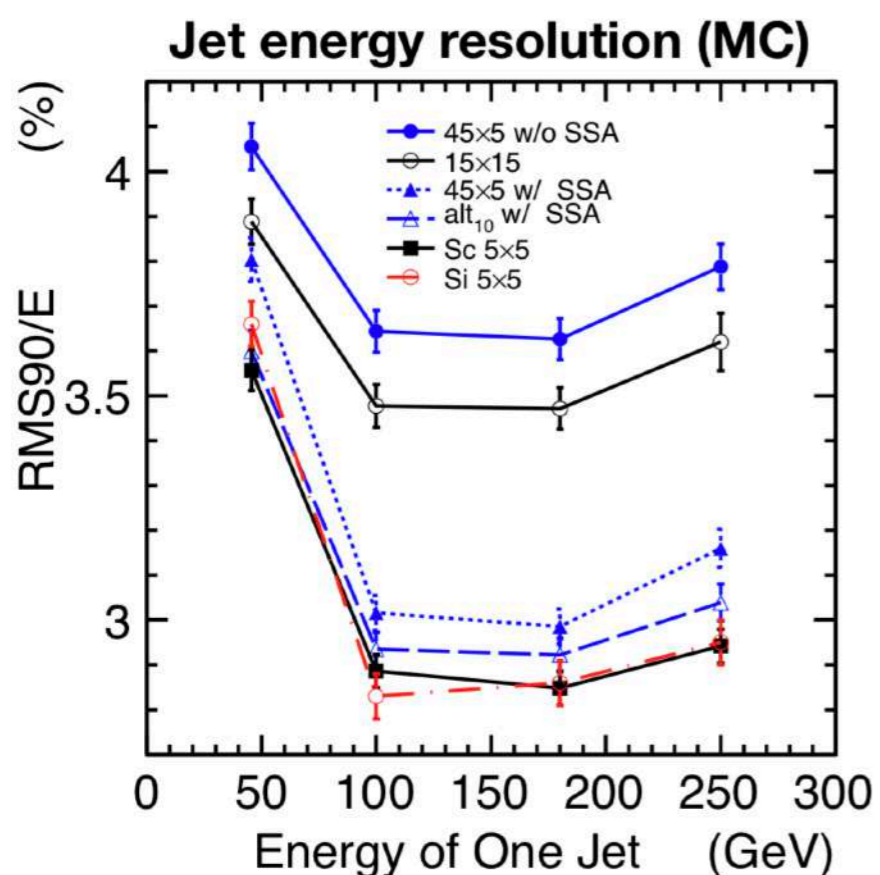
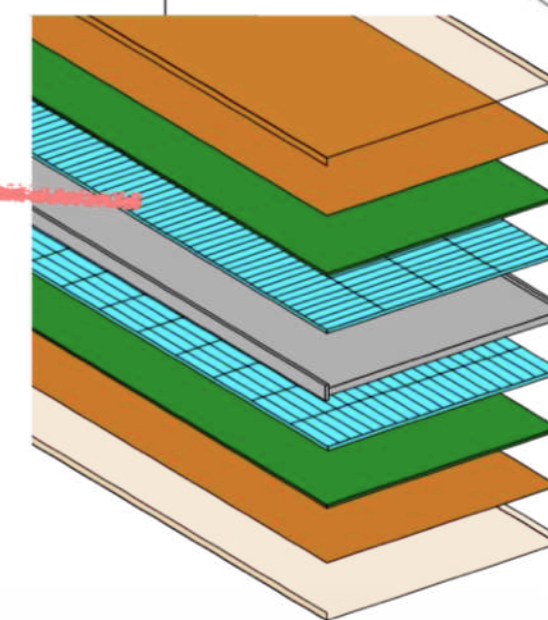
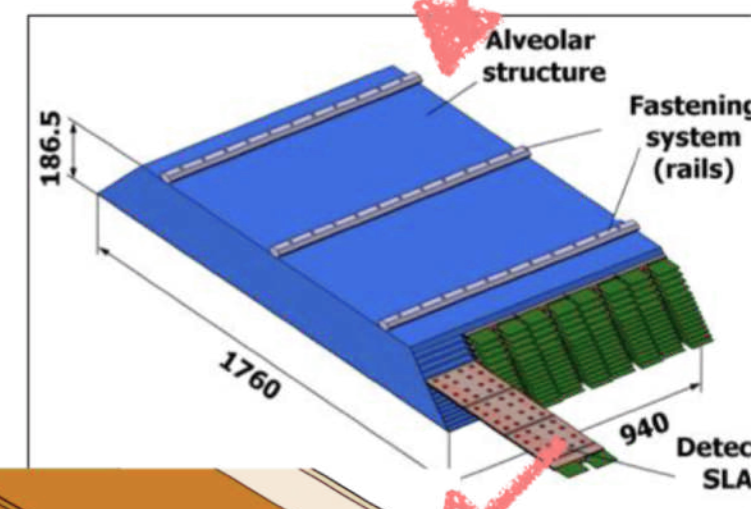
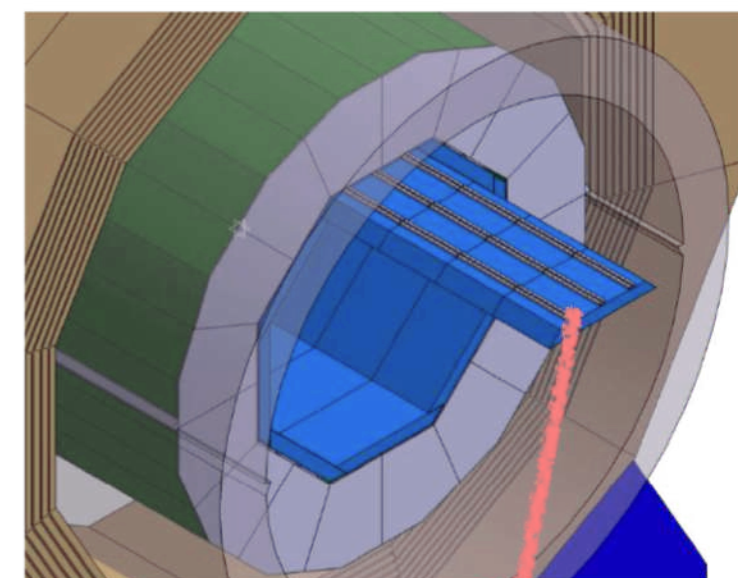

Saturation of SiPMs

- MPPC saturation can be an issue for Sc-ECAL
 - To measure small and dense EM shower
 - Large number of particles insert to scintillator
- MPPC saturation
 - When a large number of photons are injected to MPPC, output of MPPC can be saturated due to limited number of pixels
- Saturation curve is usually measured by direct injecting fast laser pulse (~400 nm) to MPPC
 - Time constant of emission of scintillation light (few ns) is not negligible compared to recovery time of MPPC cell (dozens ns)
- **Our idea is to measure the MPPC saturation with scintillation light excited by UV pulse laser**
 - **The measured saturation curve can directly be used for saturation correction**

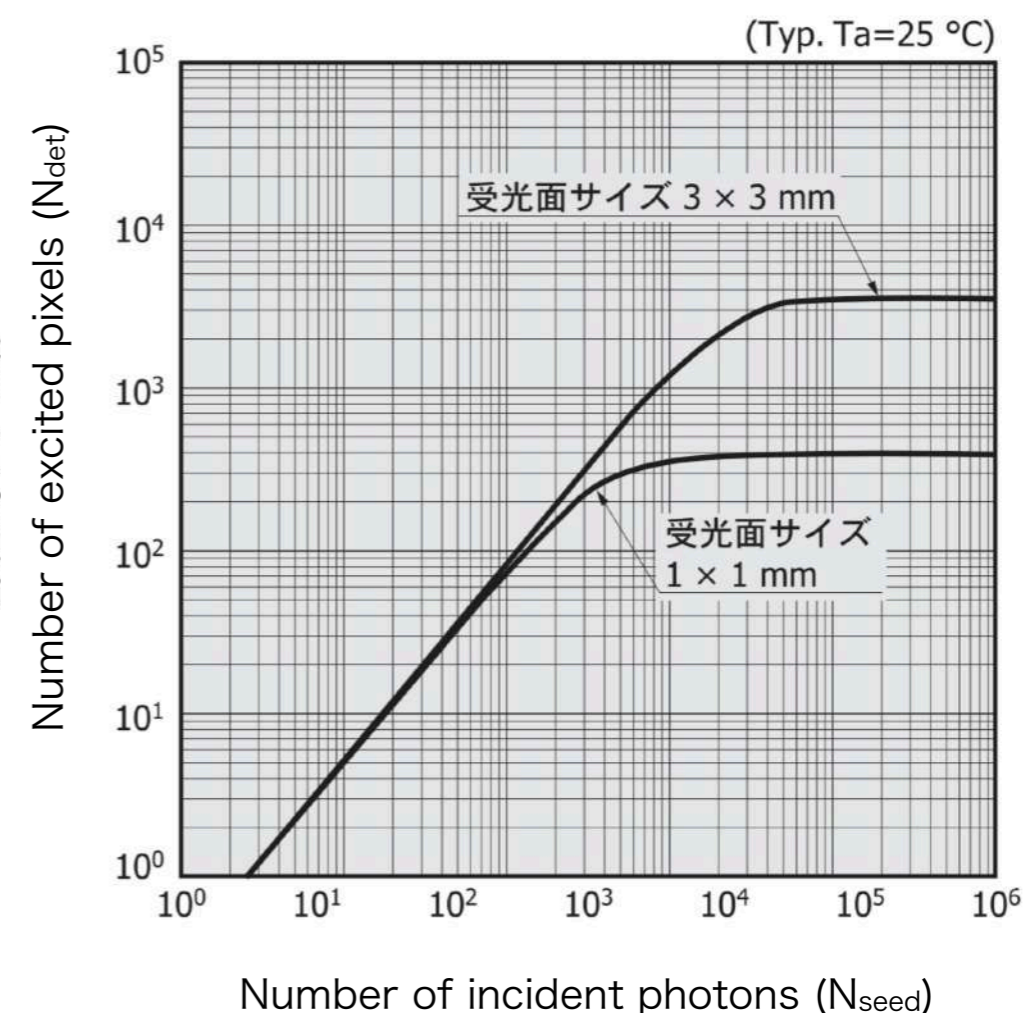

Hamamatsu Photonics K.K.,
Opto-semiconductor Handbook

MPPCs for Sc-ECAL

- Hamamatsu MPPC S12571 series
 - Small pixel size : 10 / 15 μm
 - Active area : 1 × 1 mm^2
 - Breakdown voltage : 65 V
 - **No Trench isolation**
- Hamamatsu MPPC S14160 series
 - Small pixel size : 10 / 15 μm
 - Active area : 1.3 × 1.3 / 3 × 3 mm^2
 - Breakdown voltage : 38 V
 - **0.5 μm trench isolation** → low crosstalk

Crosstalk : IR photons from avalanche in fired pixel can trigger adjacent pixels

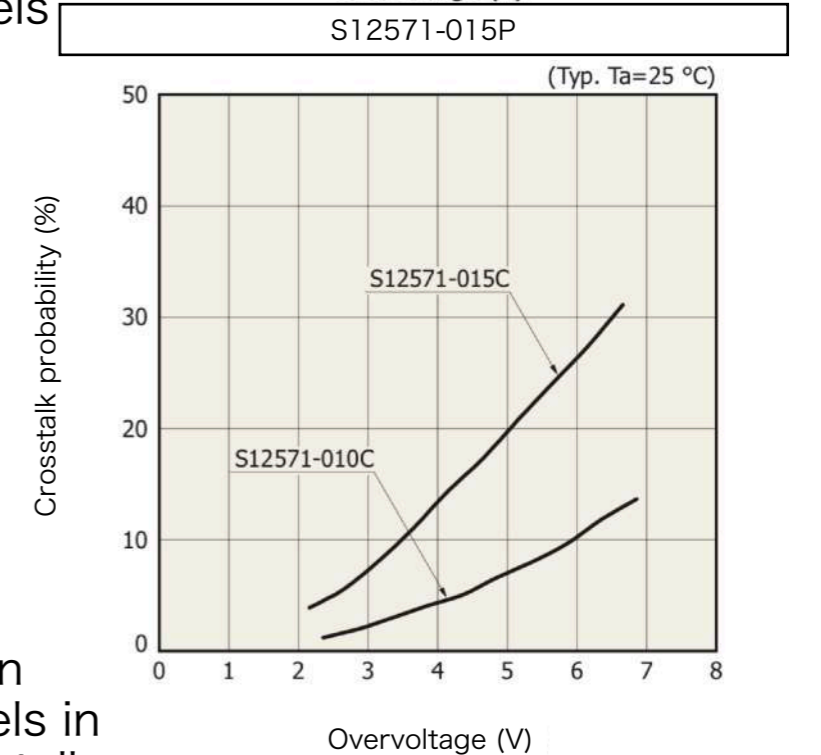
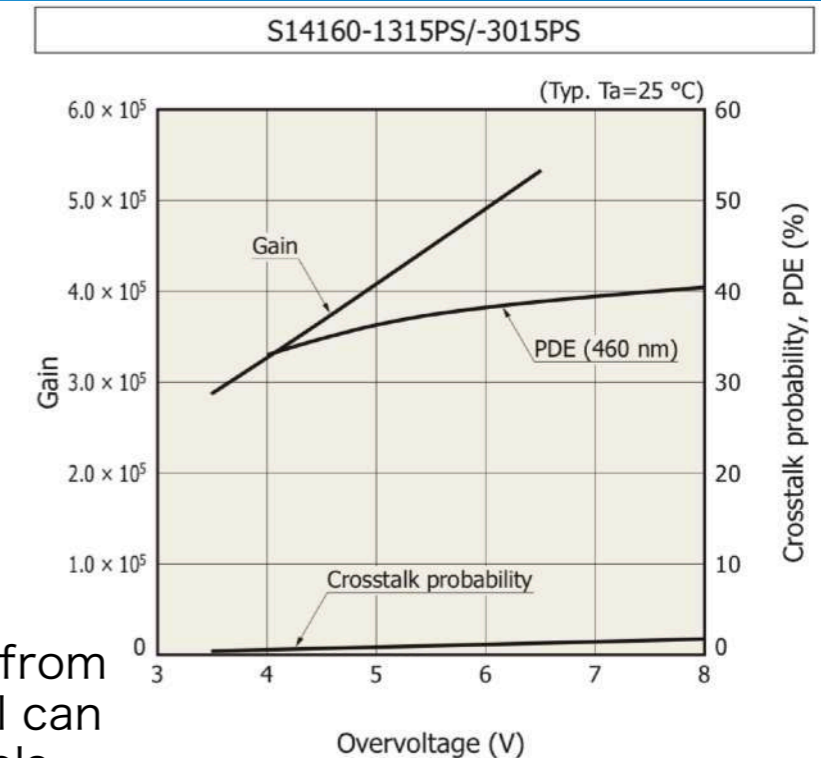

Trench : Separation between adjacent pixels in order to reduce crosstalk

Hamamatsu Photonics K. K., PD18

	S12571	S14160 (Latest)
Breakdown voltage	65 V	38 V
Trench isolation	none	Yes
Trench width	-	~ 0.5 μm
Fill factor	10 μm : 33% 15 μm : 53%	10 μm : 31% 15 μm : 49%

Cross-section of micro-cells

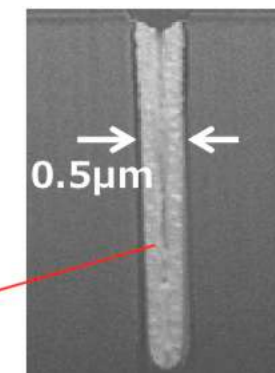
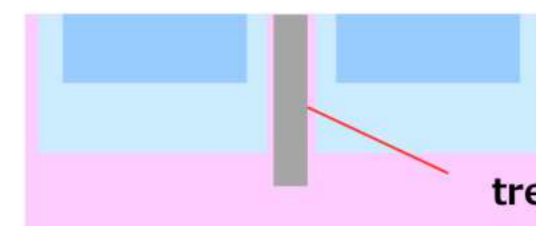

Trench technique of new MPPC

- MPPC S14160 series employ trench technique
 - Low crosstalk
 - Low operation voltage
 - No reduction of fill factor
- Longer tail due to larger cell capacitance
 - Longer recovery time
- Saturation is improved for new MPPC?
 - Low crosstalk → saturation ↓
 - Longer recovery → saturation ↑

Old design (w/o trench)

● Fill factor: 53%

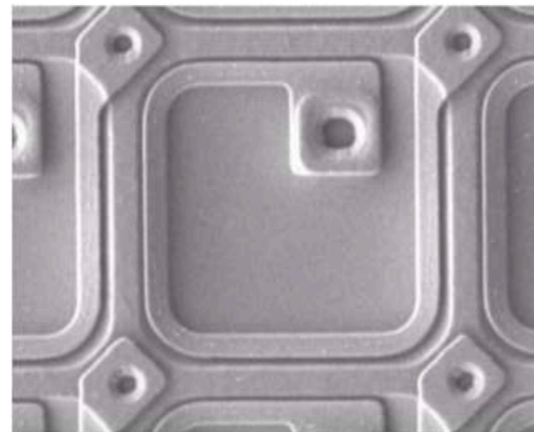

15 μm

● Fill factor: 33%

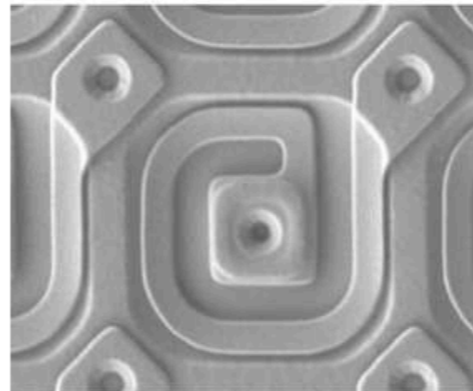

10 μm

Hamamatsu Photonics K. K., PD18
New design (w/ trench)

● Fill factor: 49%

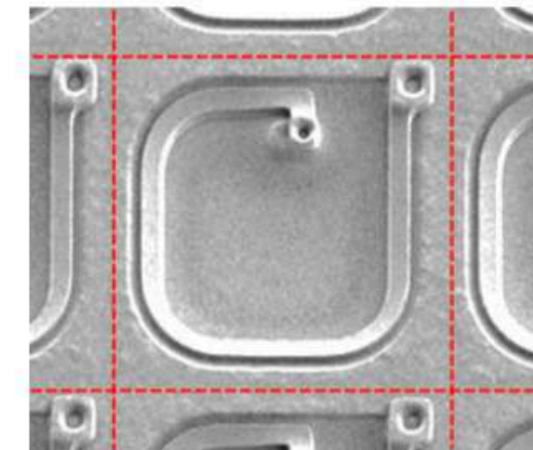

trench

● Fill factor: 31%

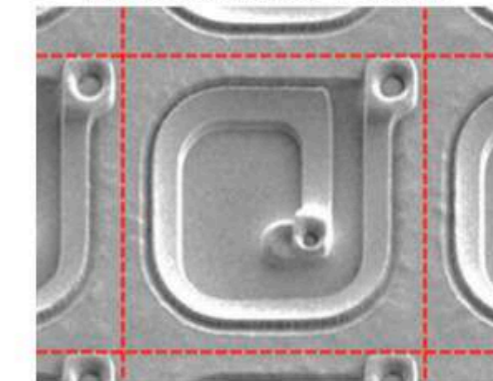

trench

S14160-3015 vs. S12572-015

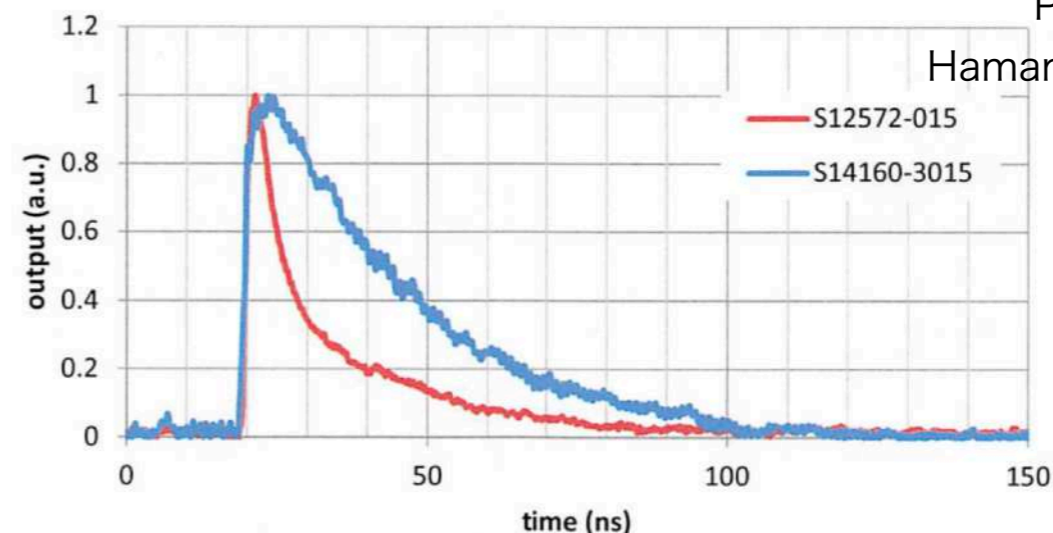

Provided by Hamamatsu Photonics

Experimental setup

- Laser
 - 190 nm laser : Scintillation excitation, invisible to MPPC
 - 470 nm laser : No scintillation excitation, directly detected by MPPC
- Setup for Sc-ECAL
 - $5 \times 45 \times 2 \text{ mm}^3$ scintillator strip (EJ-212) with center dimple
 - MPPC w/o trench : S12571-015P
 - Active area : $1.0 \times 1.0 \text{ mm}^2$
 - Pixel pitch : $15 \mu\text{m}$
 - 4489 pixels
 - MPPC w/ trench : S14160-1315PS
 - Active area : $1.3 \times 1.3 \text{ mm}^2$
 - Pixel pitch : $15 \mu\text{m}$
 - 7296 pixels

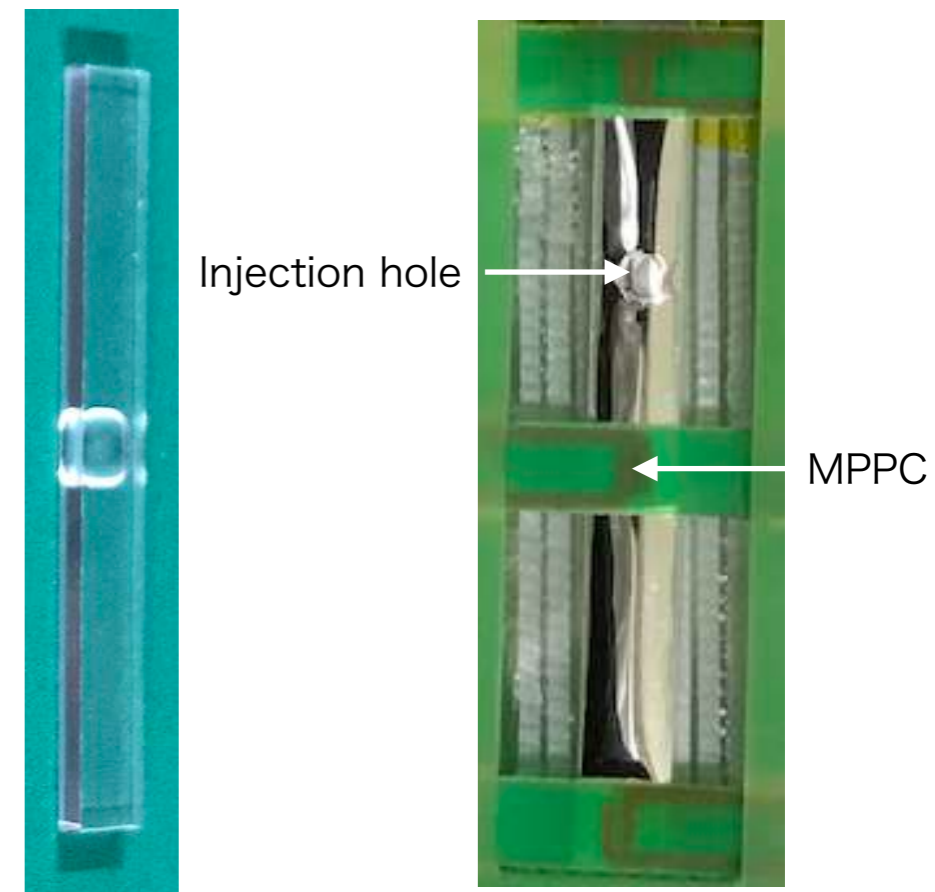

Experimental setup

- Excite scintillation light with fast fsec UV pulse laser
 - Laser light is split using half mirror (to scintillator, to photodiode)
 - Incident light intensity is monitored with photodiode
 - MPPC S12571-015P with over voltage of +4 V (Recommended voltage by Hamamatsu)
 - MPPC S14160-1315PS with over voltage of +4 V (")
 - Signal attenuations (10 - 40 dB) used to avoid saturation of electronics

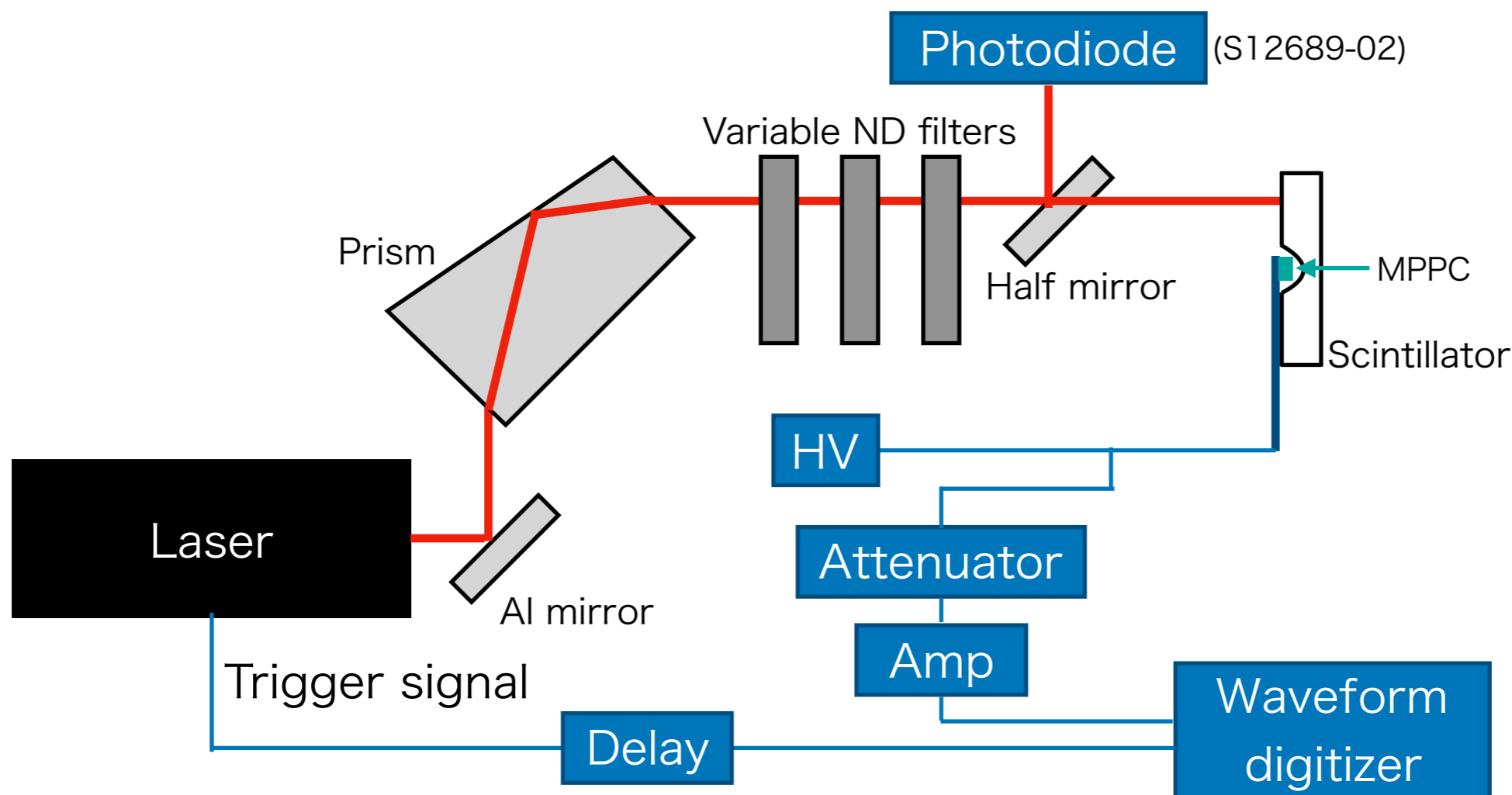

Experiment setup

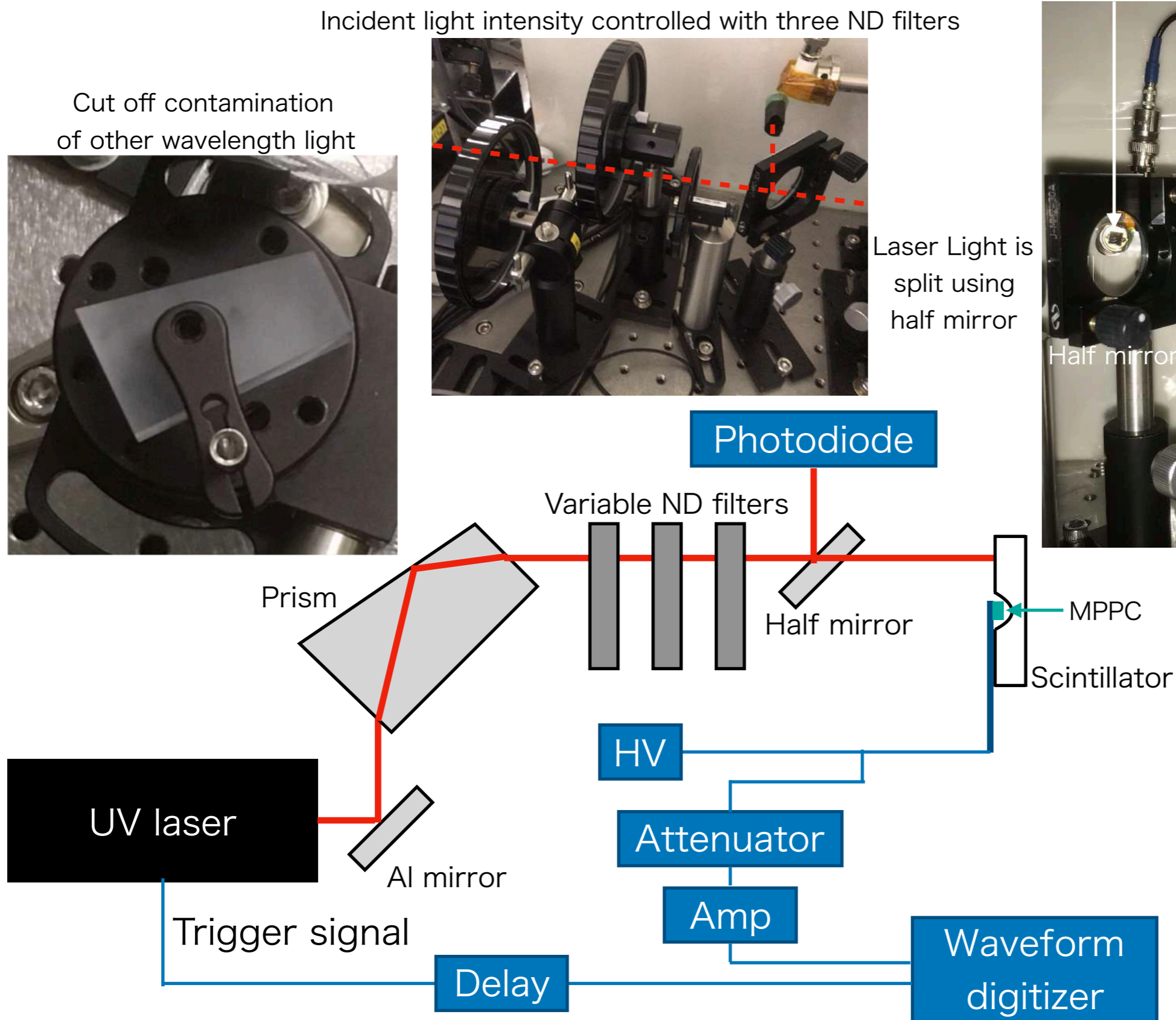

Incident light intensity controlled with three ND filters

Cut off contamination of other wavelength light

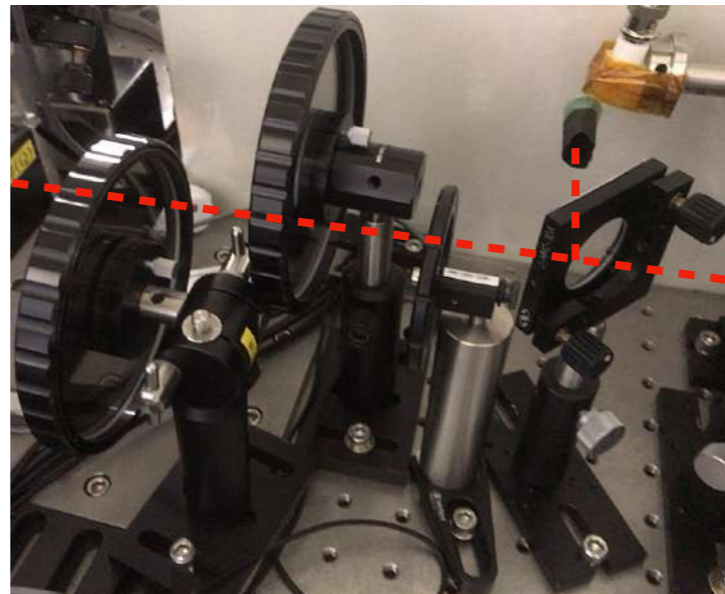

Laser Light is split using half mirror

Photodiode



Scintillator & PCB

Half mirror

Photodiode

Variable ND filters

Prism

Half mirror

MPPC

Scintillator

HV

Attenuator

Amp

Waveform digitizer

Trigger signal

Delay

Signal waveform

- Waveform is compared among 190 nm laser, 470 nm laser, and Sr90
 - 190 nm laser, Sr90 → MPPC detects scintillation light
 - 470 nm laser → MPPC detects laser light directly
 - Almost the same waveform b/w 190 nm and Sr90
 - Faster signal for direct injection of 470 nm laser
- ➔ Suggesting that injected UV laser really excites scintillation light !

S12571-015P (MPPC w/o trench)

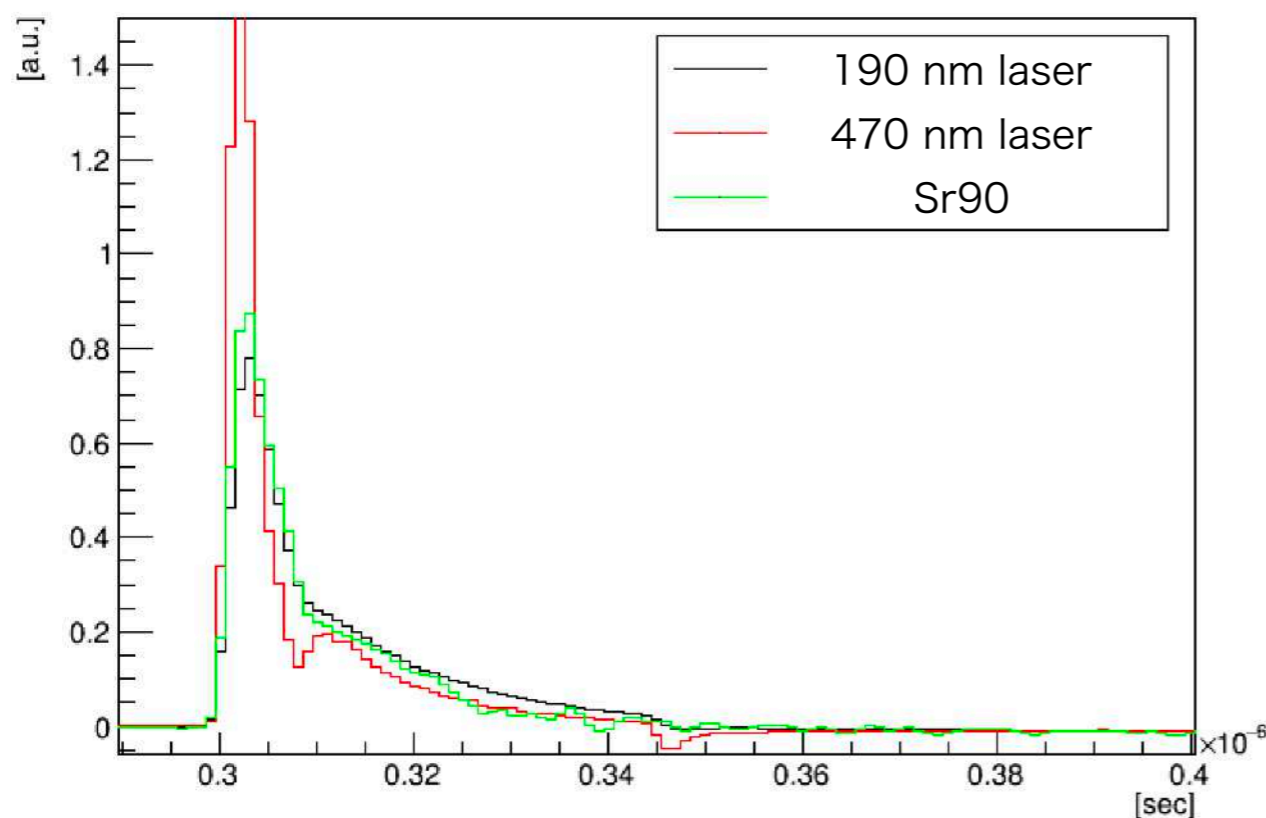

S14160-1315PS (MPPC w/ trench)

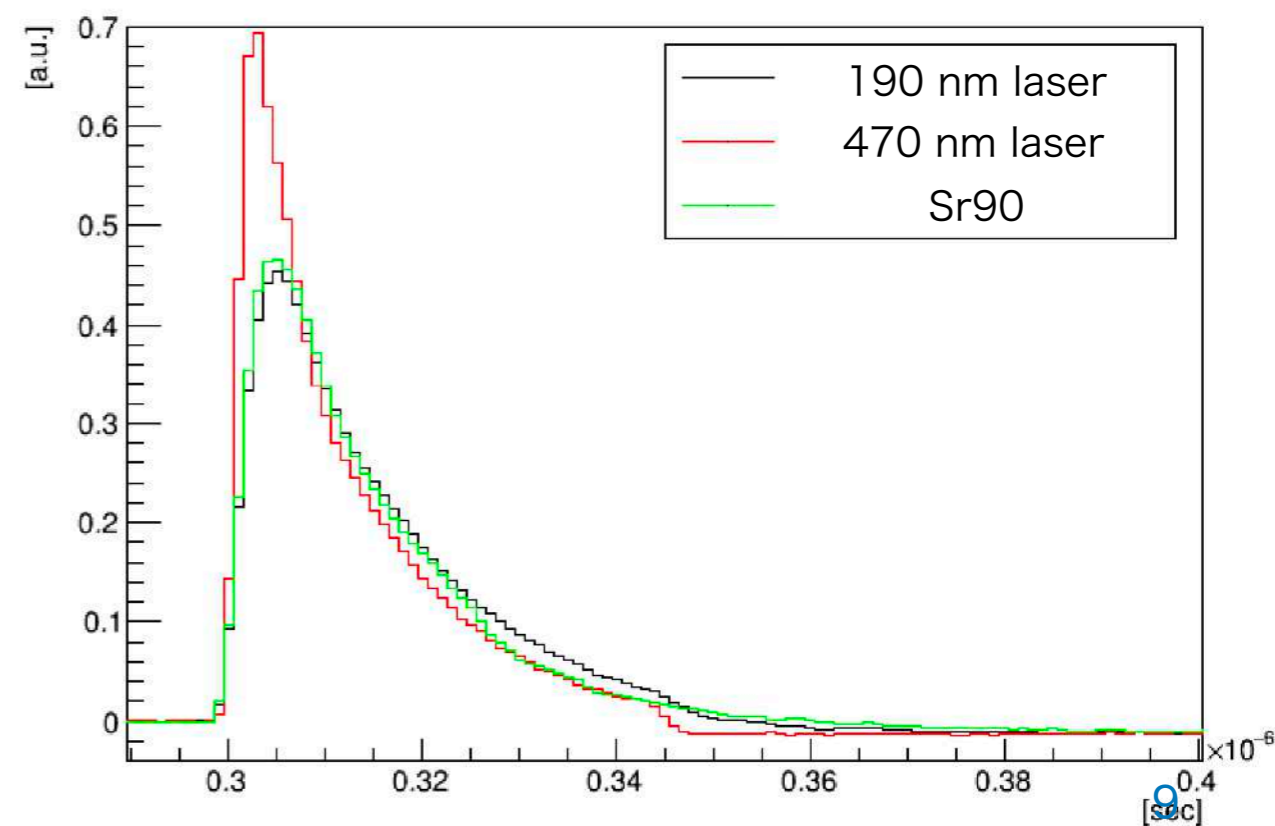

Analysis

- Digitized waveform is integrated to estimate charge.
- The charge is then converted into number of photoelectrons being divided by single photoelectron charge.
- Single photoelectron charge is obtained from dark noise signal found in off-time region

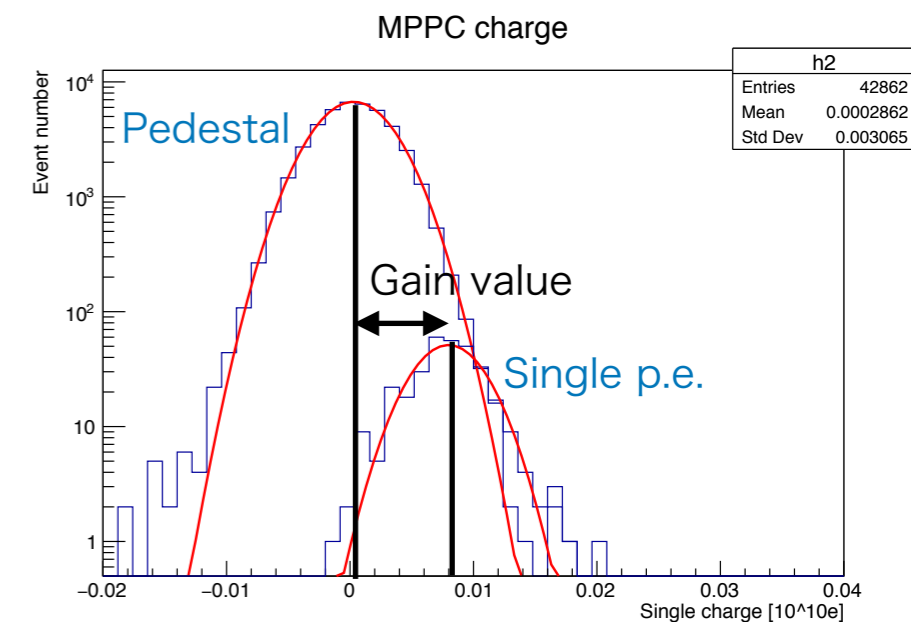
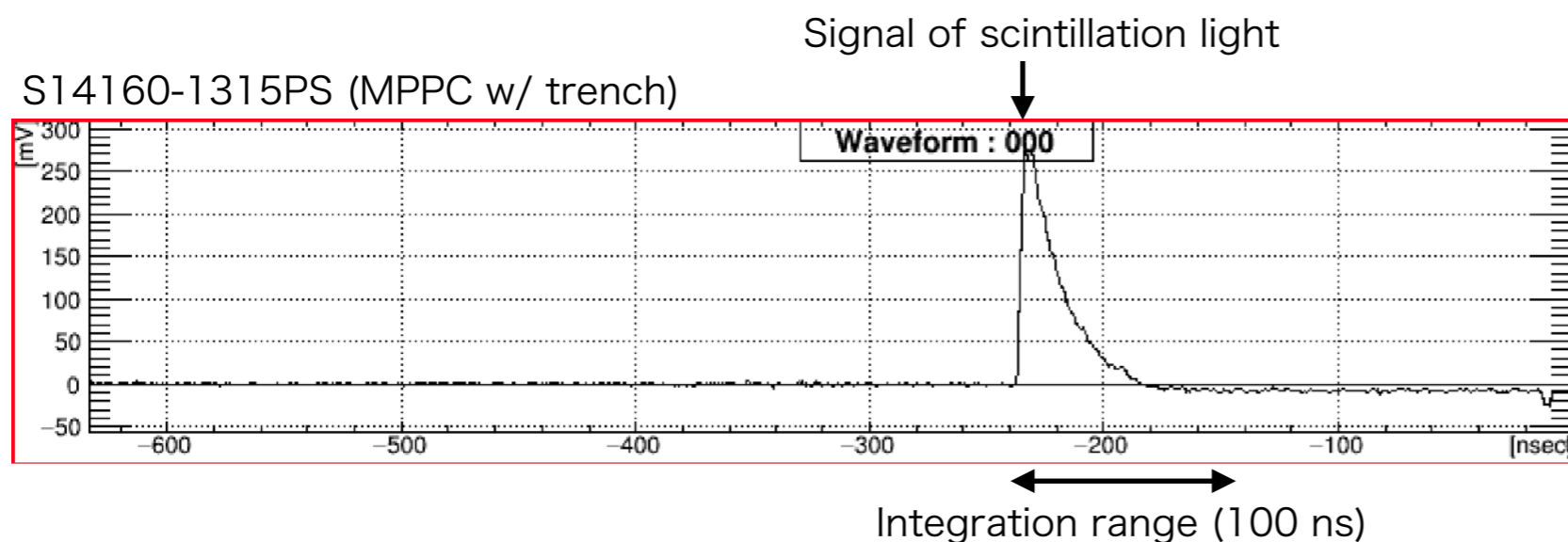
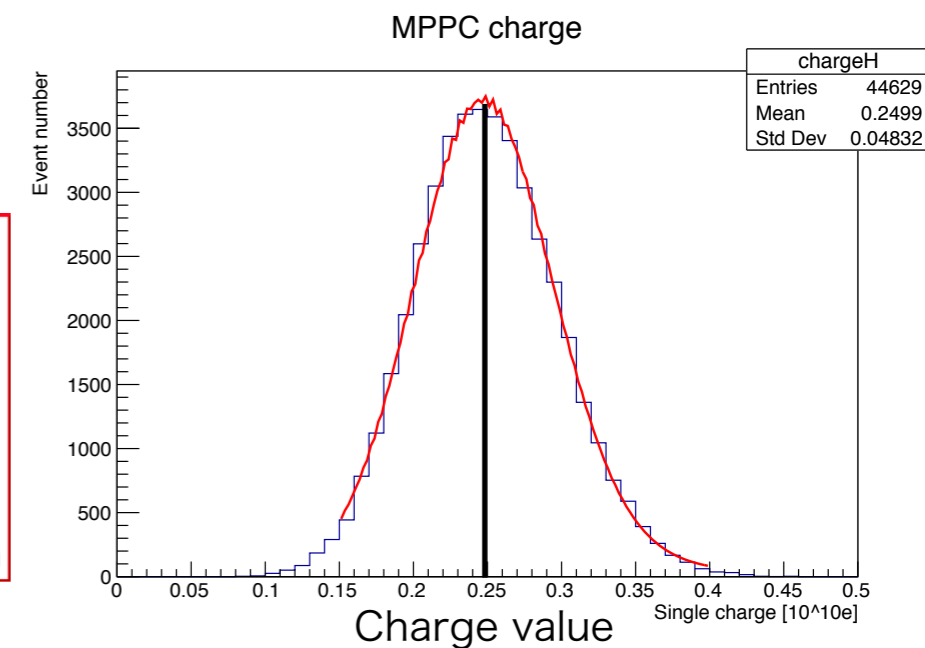
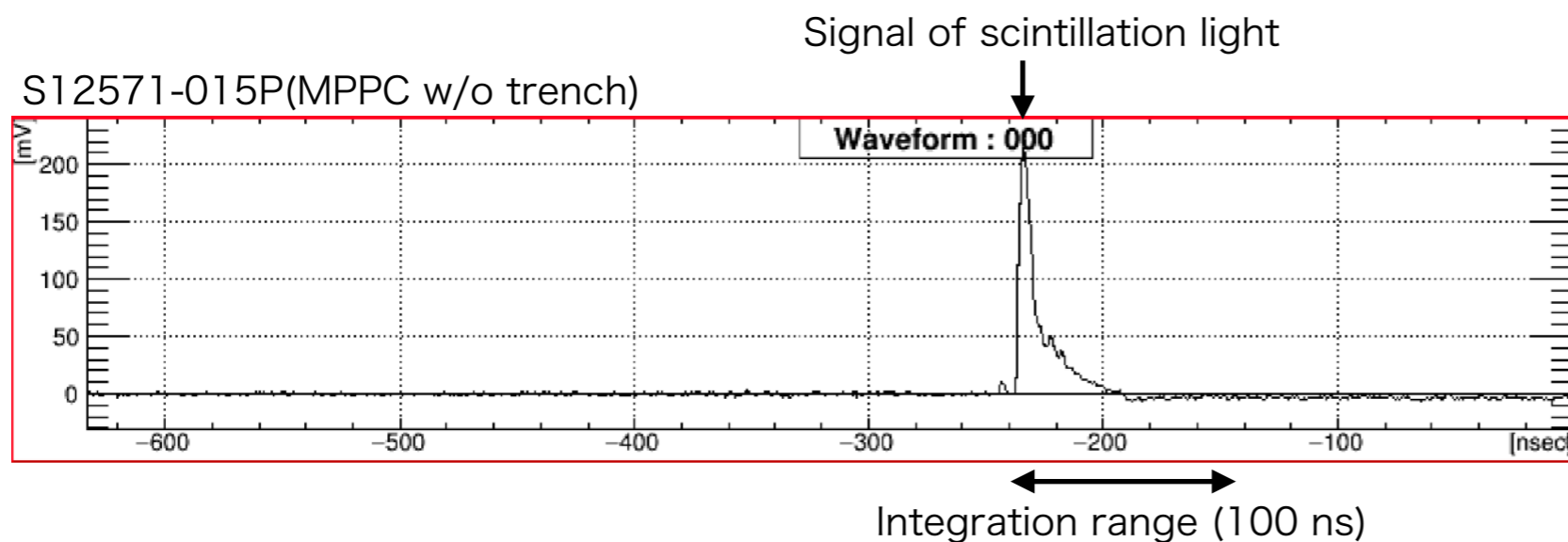

Laser intensity

- Incident light intensity is monitored with photodiode
 - Laser light is split using half mirror
- Photodiode current is converted to N_{seed} using calibration constant obtained at low light intensity where no saturation is anticipated
 - (N_{seed} : number of photoelectrons when assuming no saturation)
- Effect of crosstalk and after-pulse is not corrected yet

Linear region of S12571-015P (MPPC w/o trench)

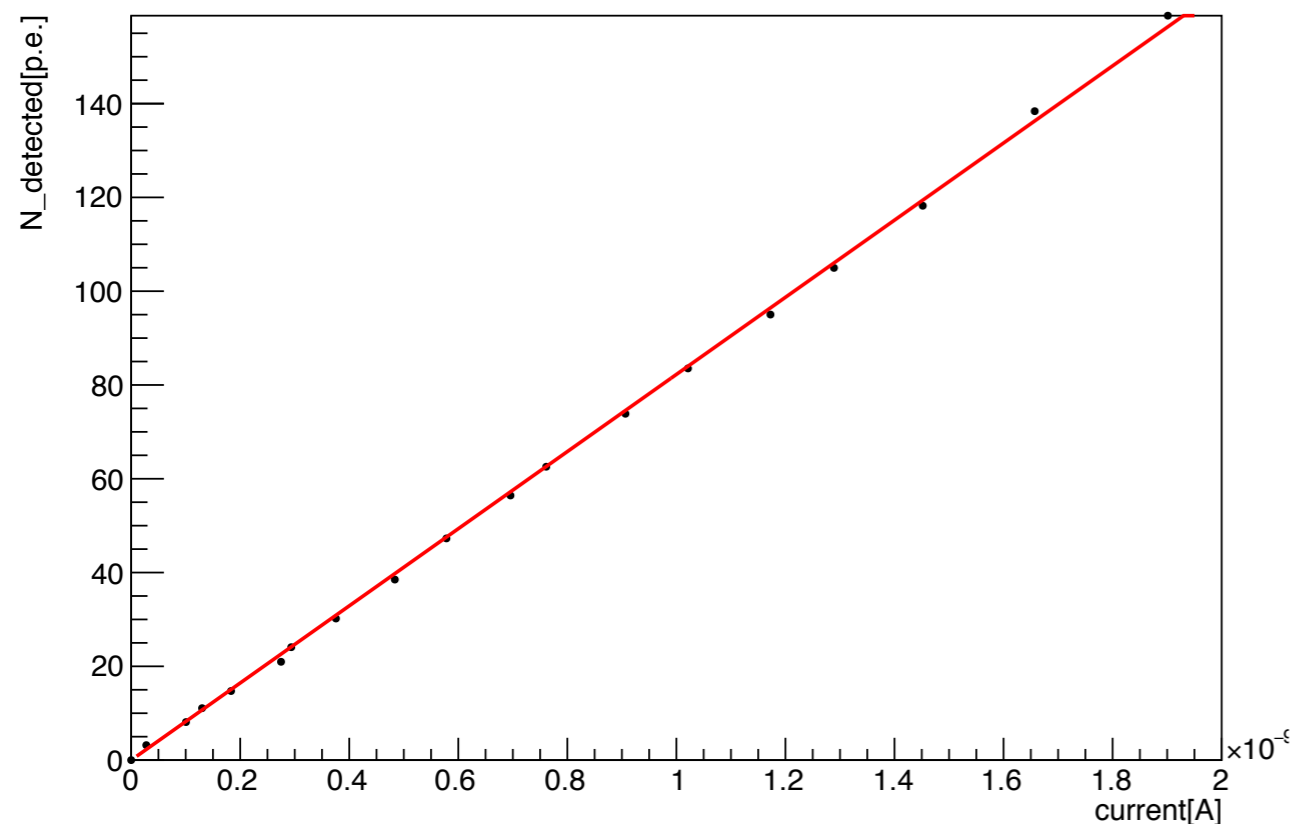

Linear region of S14160-1315PS (MPPC w/ trench)

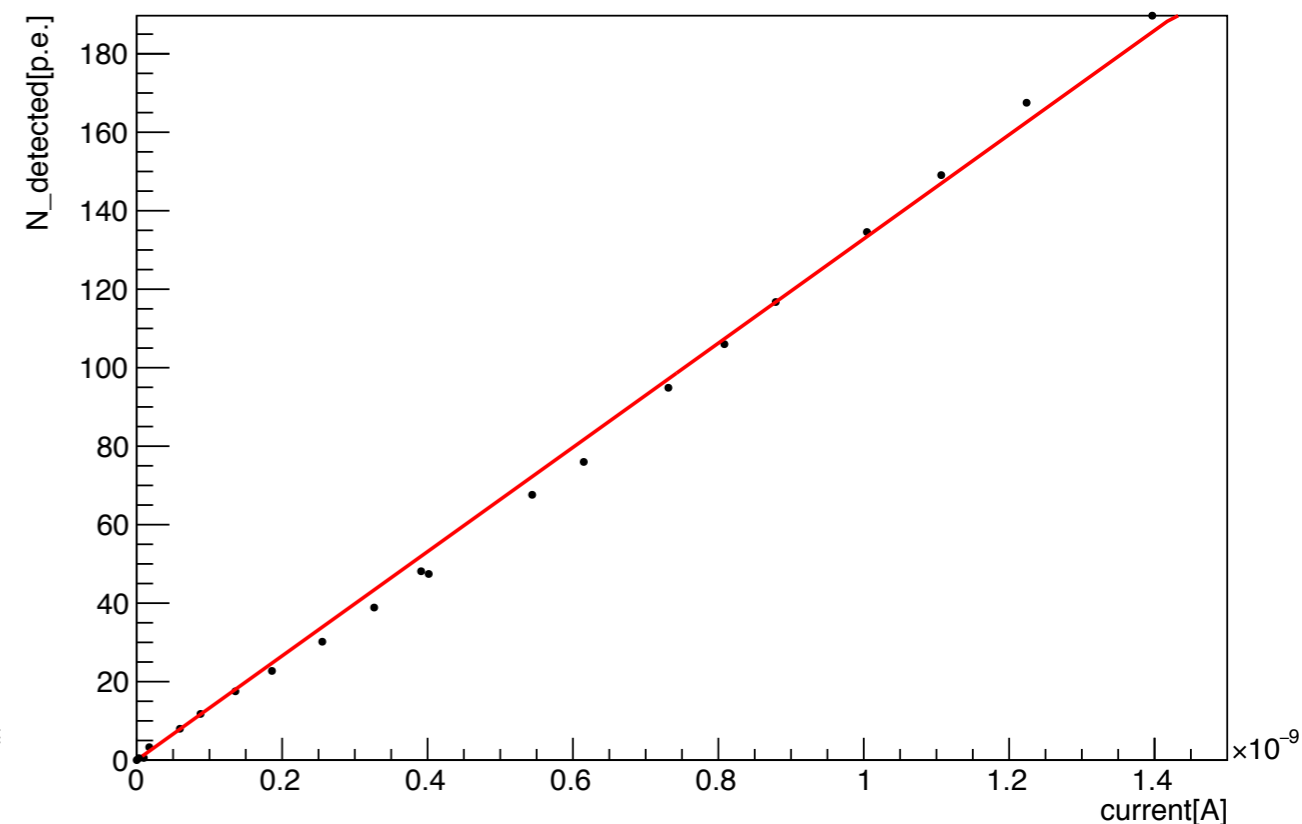

Saturation curve with 190 nm laser

- Over-saturation is observed for both MPPCs
- N.B. still some uncertainties in estimation for signal attenuation factors
 - We observed that the attenuation factor depends on light intensity
 - Probably due to change in signal shape caused by MPPC saturation

UV scan of S12571-015P (MPPC w/o trench)

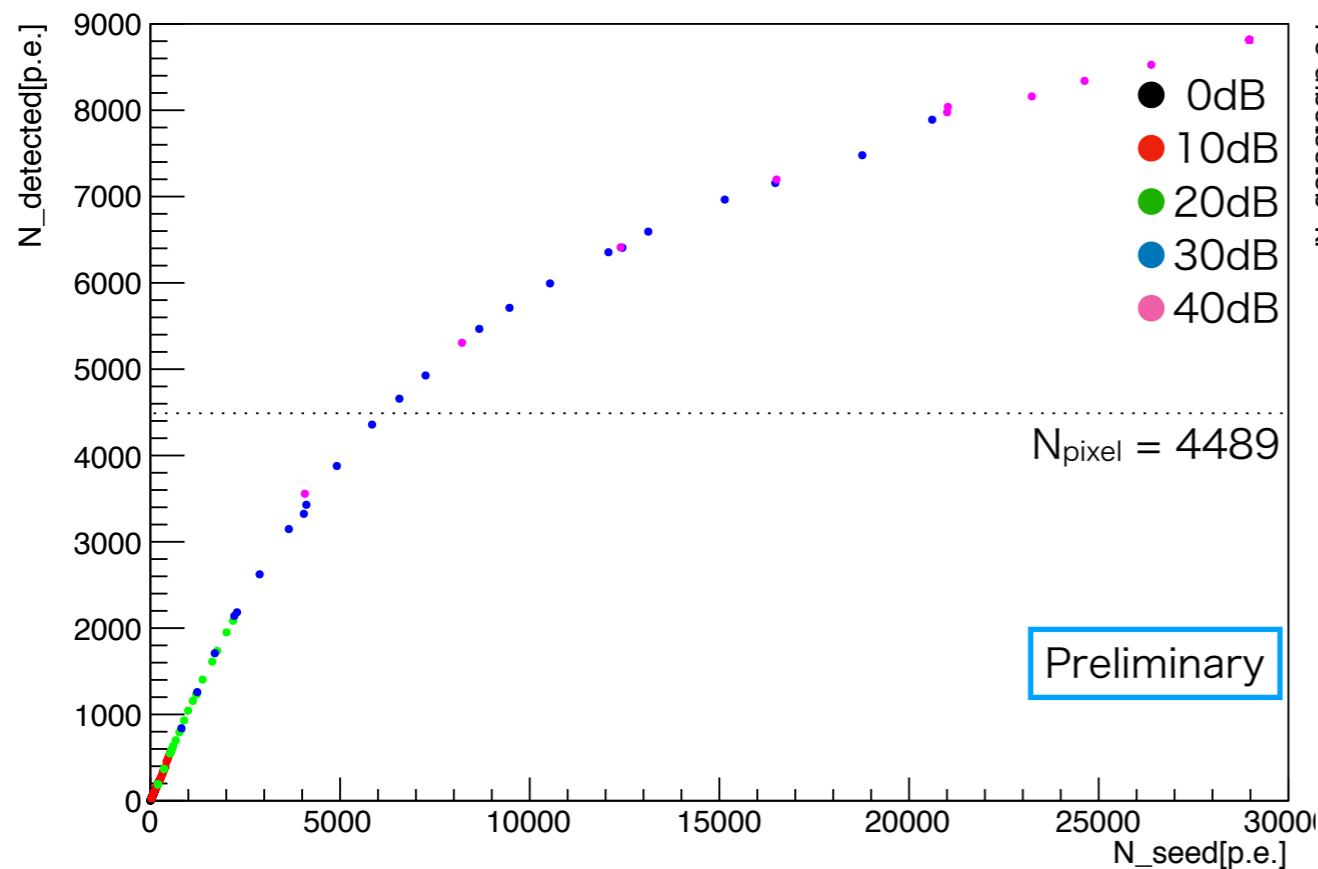

UV scan of S14160-1315PS (MPPC w/ trench)

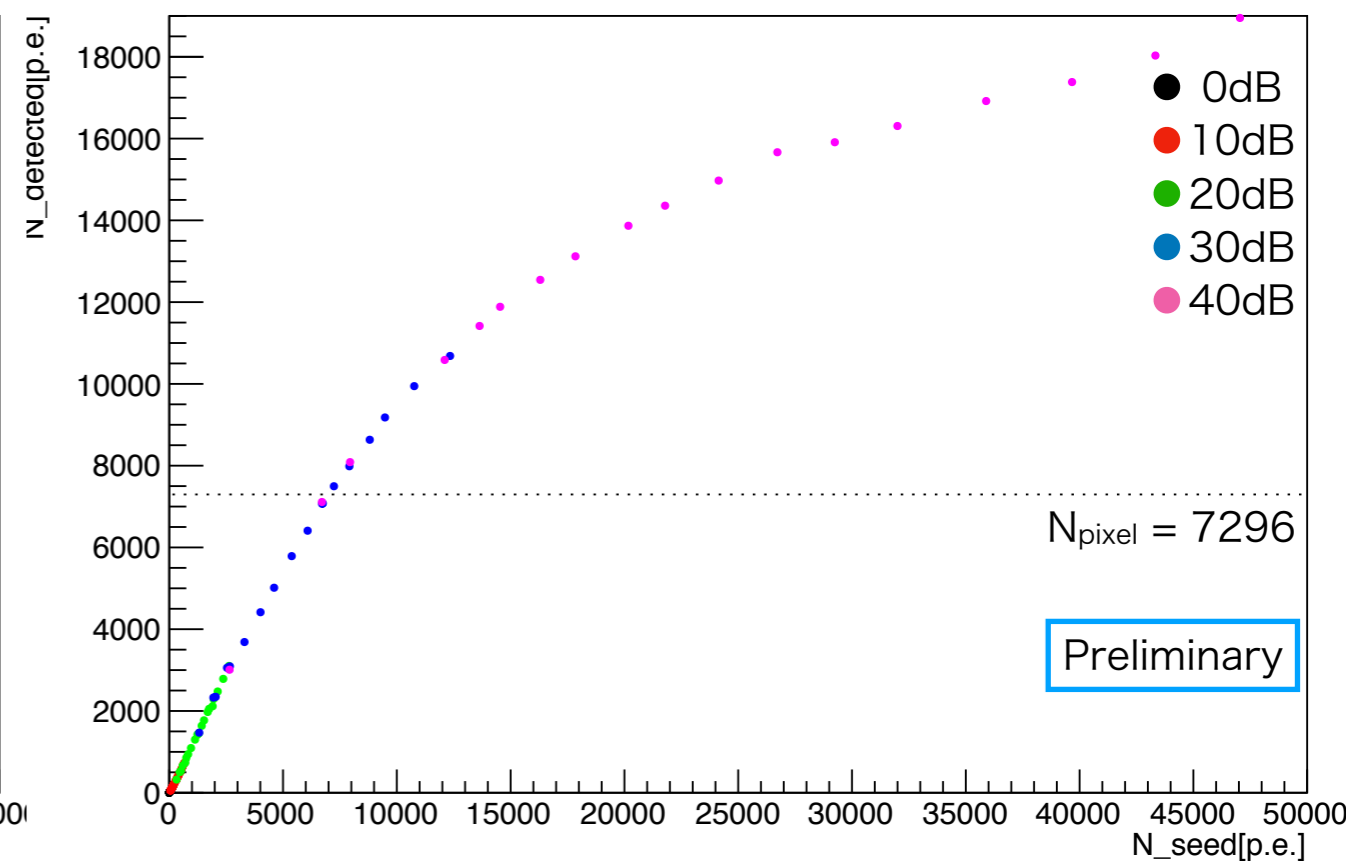

Saturation curve with 470 nm laser

- Over-saturation is still observed for both MPPCs
 - Due to after pulse and delayed crosstalk?
- N.B. still some uncertainties in estimation for signal attenuation factors
- Unstable readout of photodiode current at small Npe region

470 nm scan of S12571-015P (MPPC w/o trench)

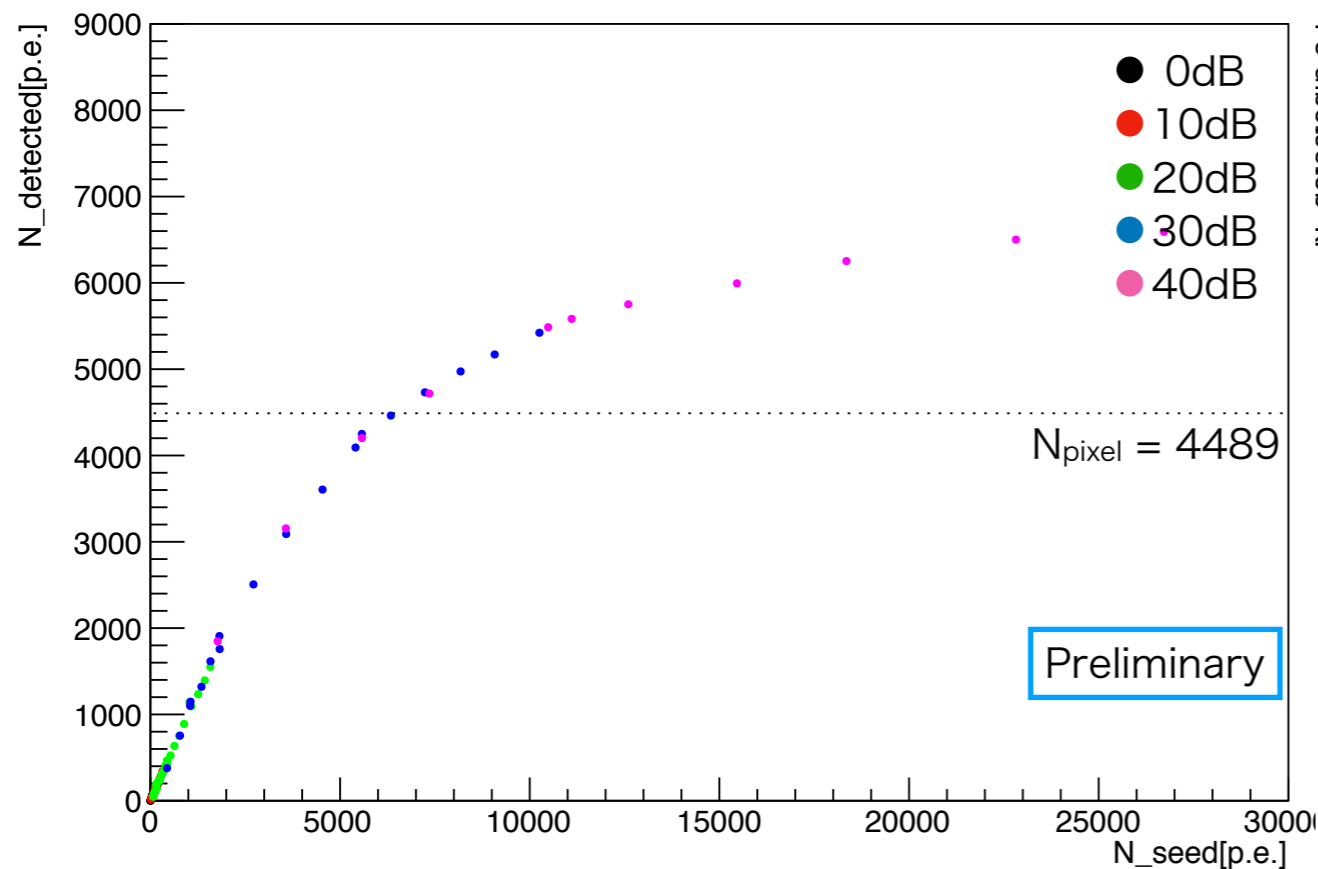

470 nm scan of S14160-1315PS (MPPC w/ trench)

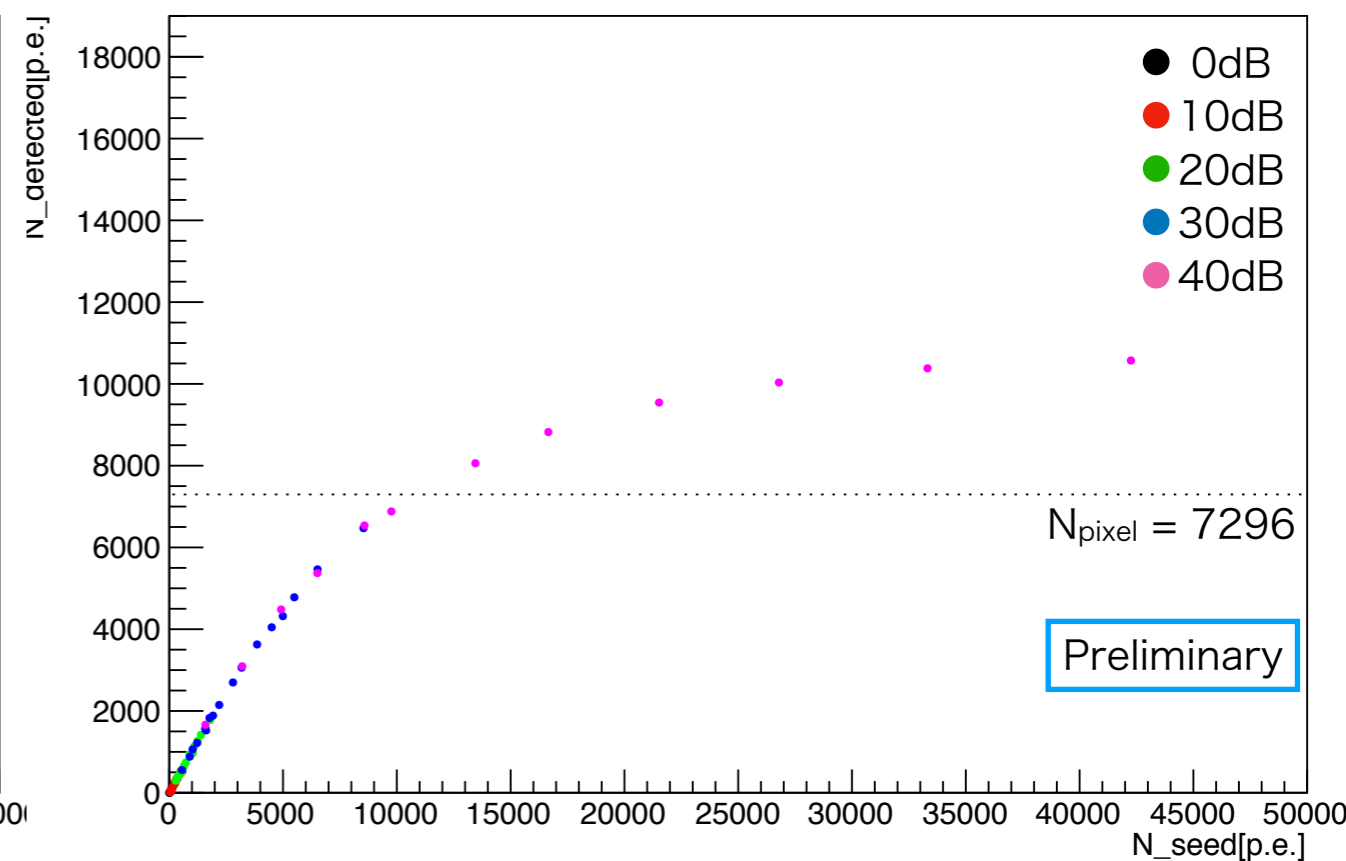

Comparison of 190 nm and 470 nm laser

- Significant difference between saturation curves with 190 nm and 470 nm laser
- **The effect of time constant of scintillation light emission is observed**
 - Can be a big impact on saturation correction

Comparison of S12571-015P (MPPC w/o trench)

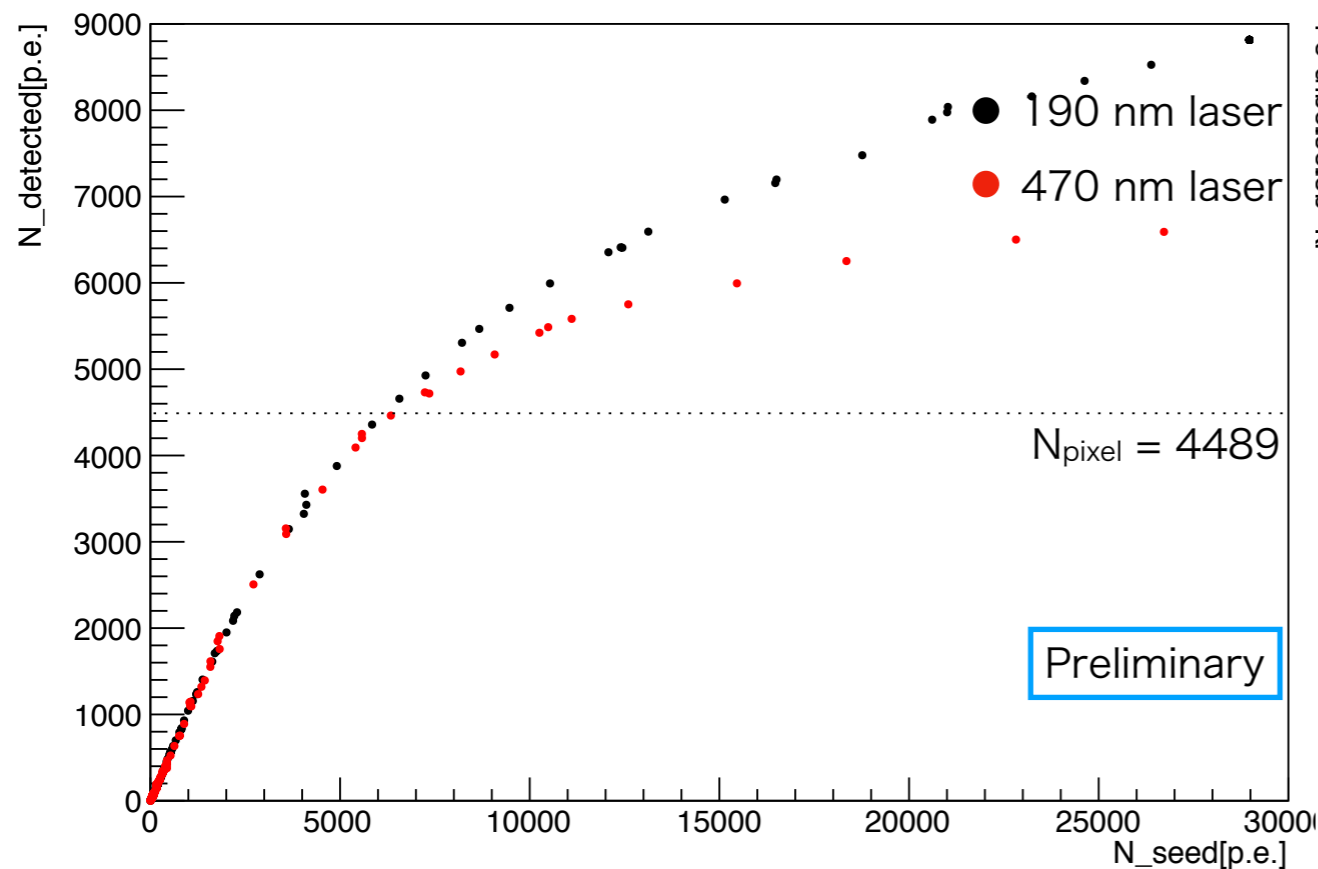

Comparison of S14160-1315PS (MPPC w/ trench)

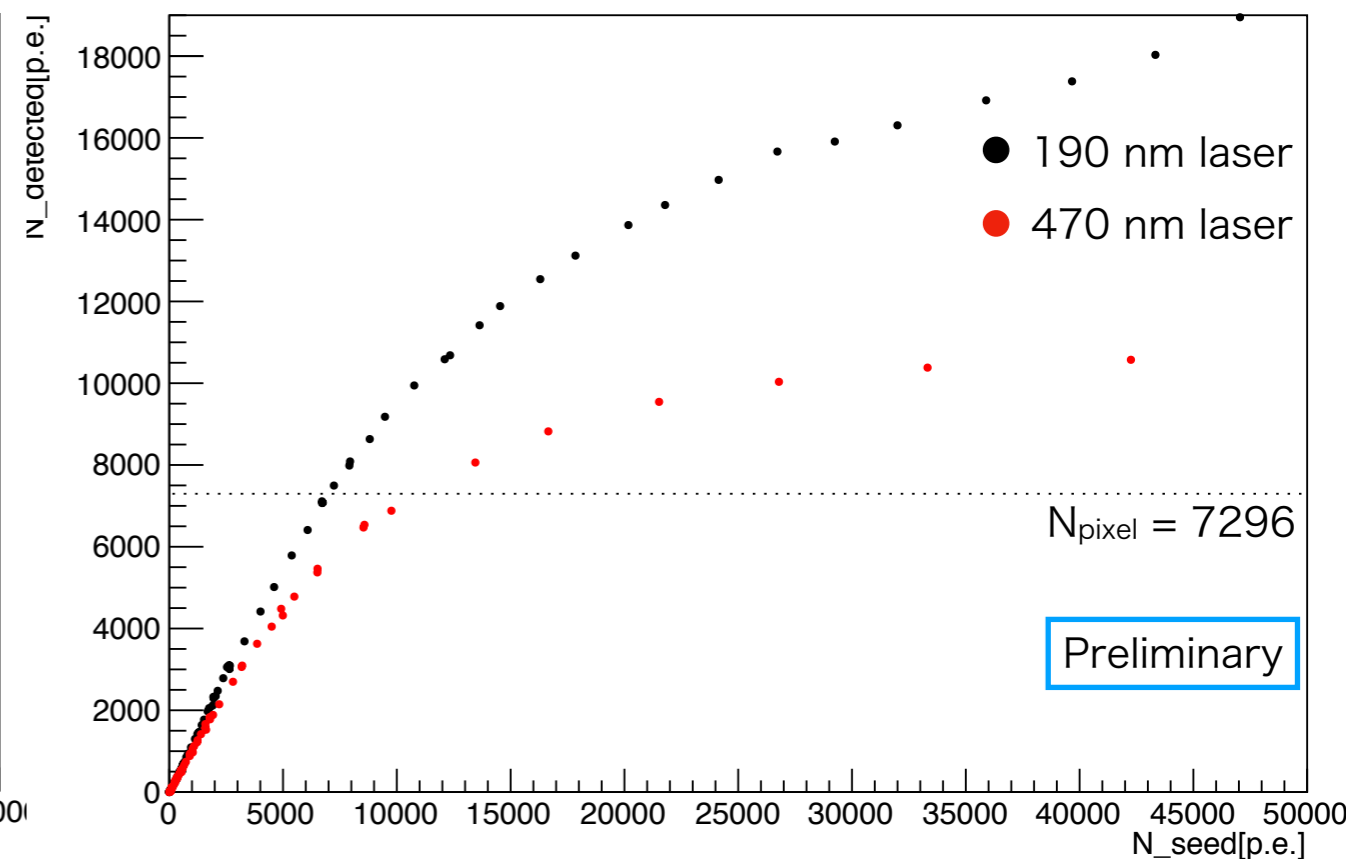

Comparison of two MPPCs with 190 nm laser

- Normalized by sensor area, PDE and crosstalk probability to compare saturation curve between two MPPCs
- S14160-1315PS (w/ trench) is less saturated compared to S12571-015P (w/o trench)
 - Few plots above the linear function (because of wrong attenuation factor?)
- **(Lower crosstalk → saturation ↓) > (Longer recovery time → saturation ↑)**
- Effect of longer recovery time is small because of scintillation emission time

Comparison with two types of MPPCs (S14160-1315PS and 12571-015P)

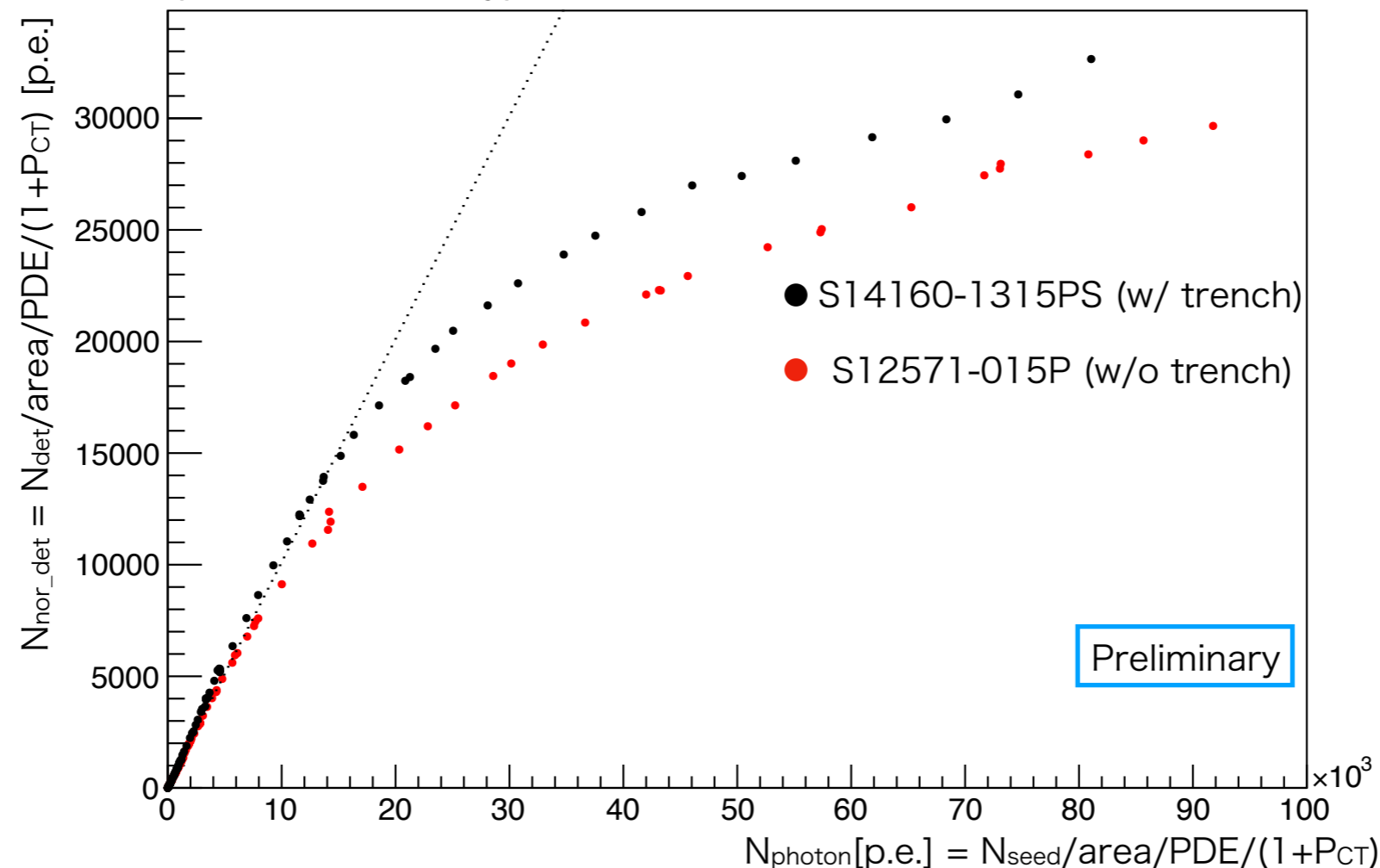

Comparison of two MPPCs with 470 nm laser

- S12571-015P (w/o trench) is less saturated compared to S14160-1315PS (w/ trench)
- **(Lower crosstalk → saturation ↓) < (Longer recovery time → saturation ↑)**
 - Effect of longer recovery time is large because of short duration of laser pulse

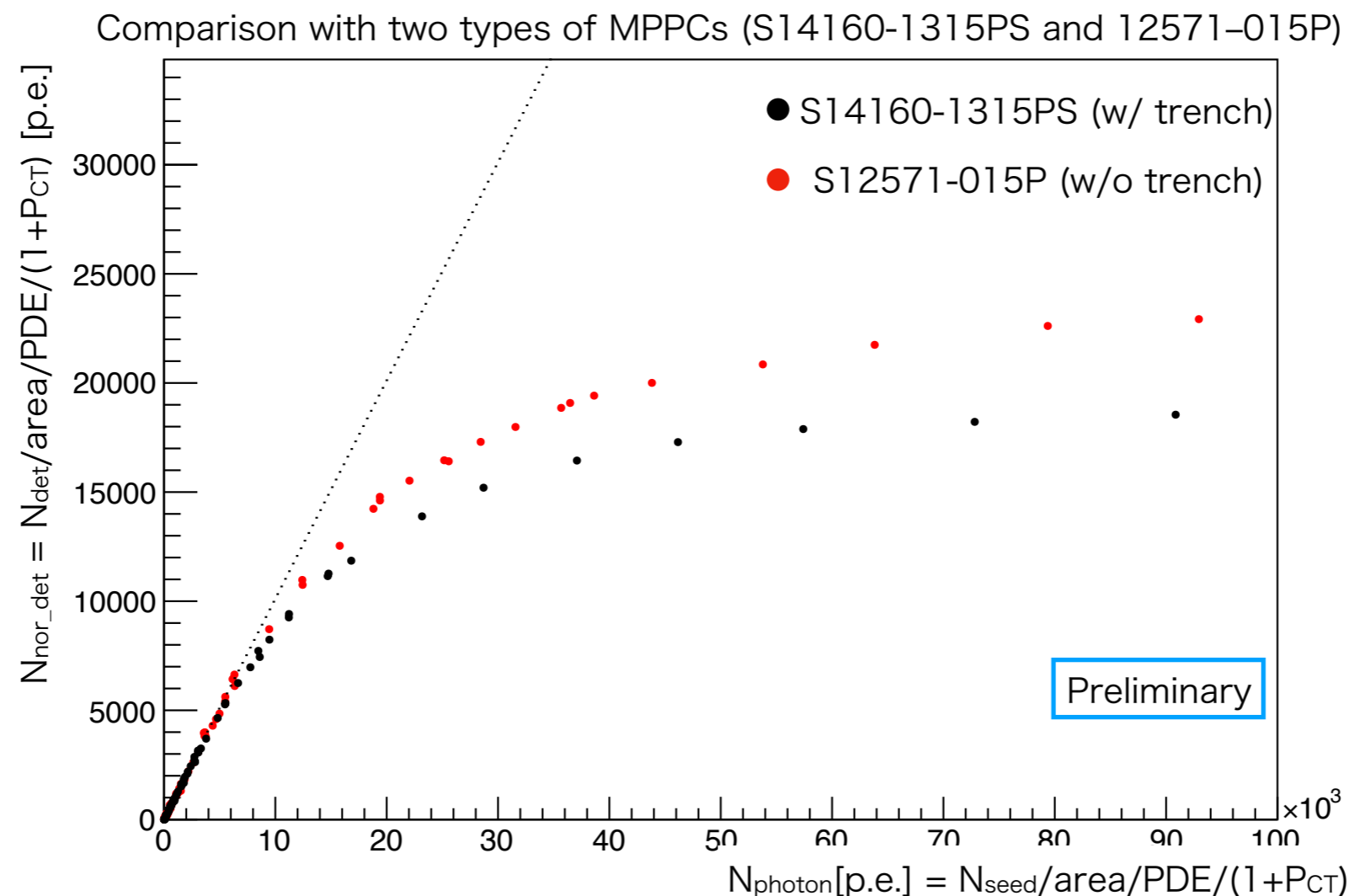

Summary & To do

- Saturation curves for MPPCs are measured using scintillation light excited by fast UV-laser with improved setup
- **Saturation recovery with scintillation light is observed.**
 - It should be taken into account for for saturation correction
 - The measured saturation curves can directly be used for correction
- Saturation curves are measured for two types of MPPCs for Sc-ECAL (w/ and w/o trench)
- **The effect of longer recovery time of S14160 (MPPC w/o trench) is found small for scintillation light**
 - Longer-tail effect is observed when the measurement of fast pulse
- To do
 - Investigate light intensity dependence of attenuation factor
 - Compare with theoretical model of saturation

Backup

Study on saturation for AHCAL (reminder)

- SiPM saturation study with UV pulse laser for AHCAL was reported by L. Liu at CALICE@Utrecht.
 - 30 × 30 mm² scintillator tile readout by Hamamatsu MPPC S13360-1325PI (active area : 1.3 × 1.3 mm², pixel pitch : 25 μm)
 - Some uncertainties such as unstable laser intensity and monitoring



- What's new**
 - Improved laser stability
 - Saturation measured by injecting 470 nm pulse laser for comparison
 - Same measurements with Sc-ECAL setup
- This talk focus on the measurements for Sc-ECAL

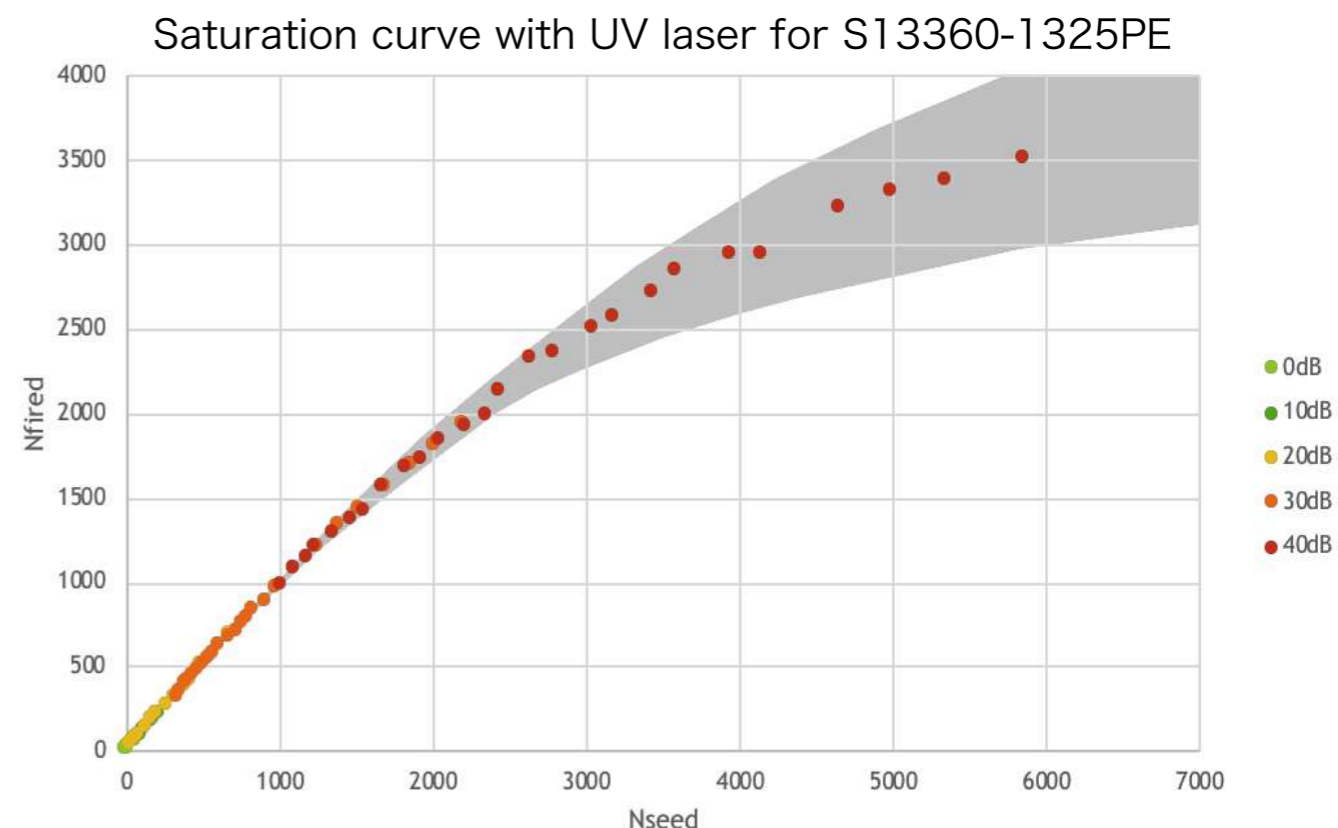

Comparison of two types of MPPCs

- These plots contain the difference of active area, crosstalk probability and PDE between two types of MPPCs
- N_{seed} and N_{det} are divided by each active area, crosstalk probability, PDE for comparison purpose
 - N_{seed} is converted into number of inserted photon (N_{photon})
 - N_{det} is converted into normalized number of detected photons (N_{nor_det})
- Then, we can see directly saturation tendency of each MPPC

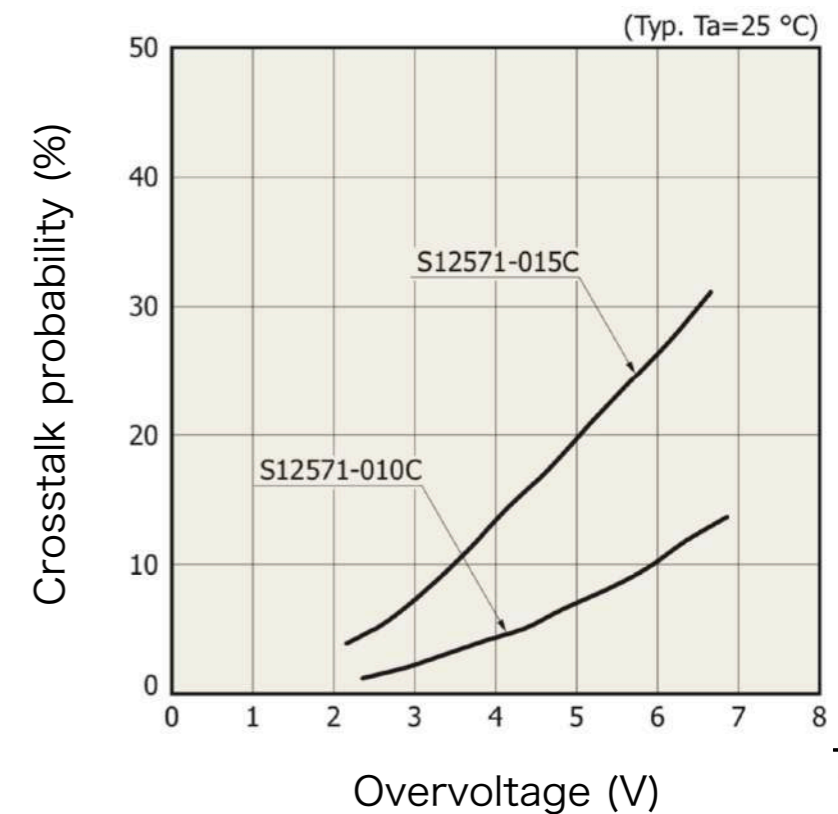
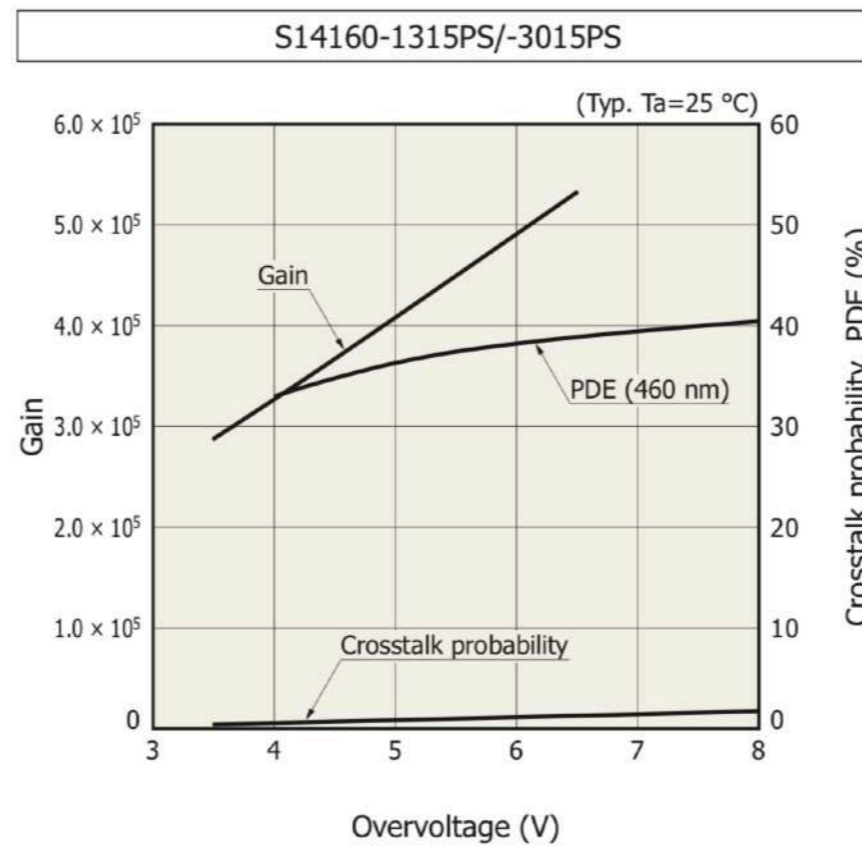
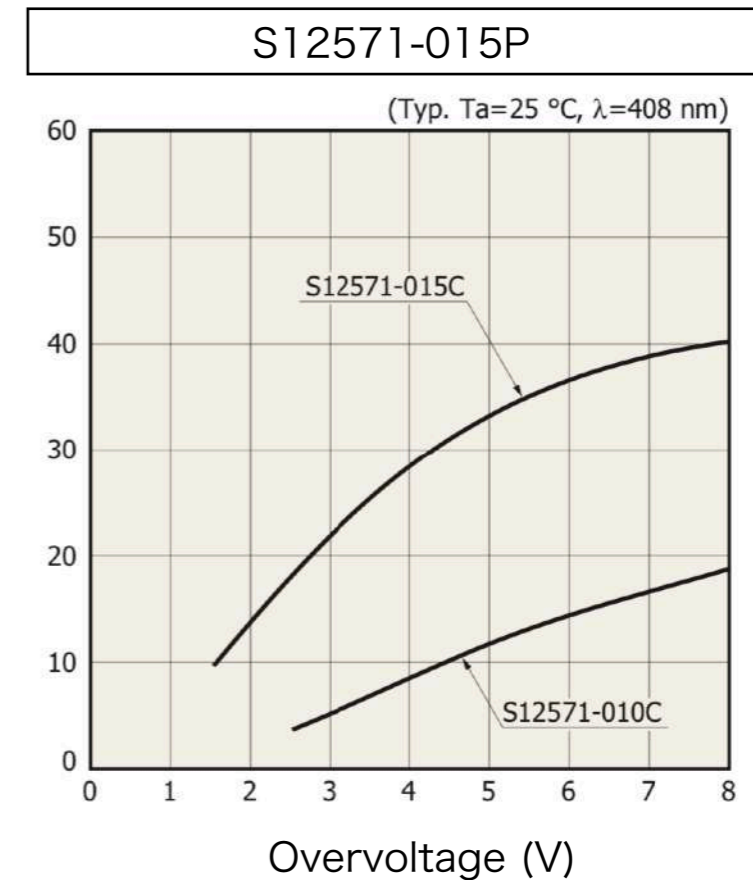

Attenuation factor 0dB vs. 10dB

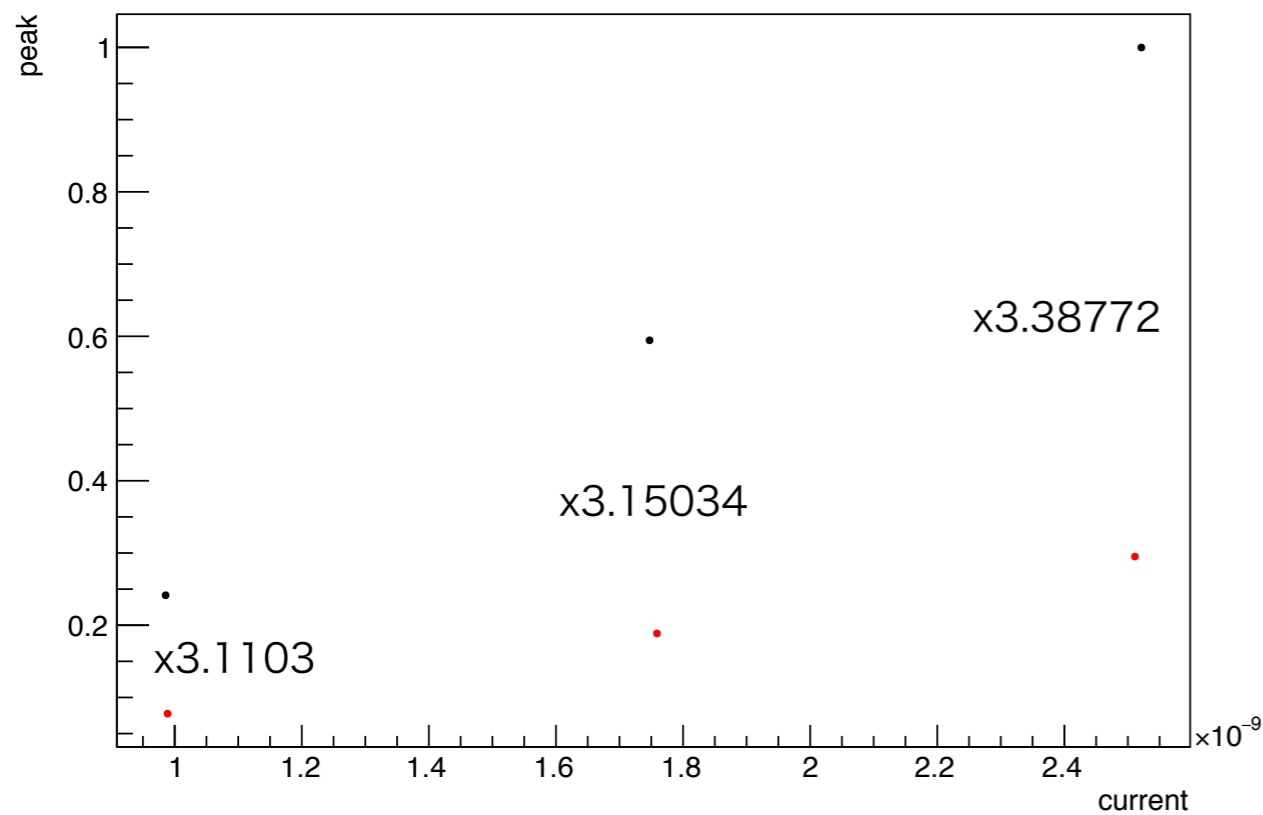

Waveforms with 0dB attenuator

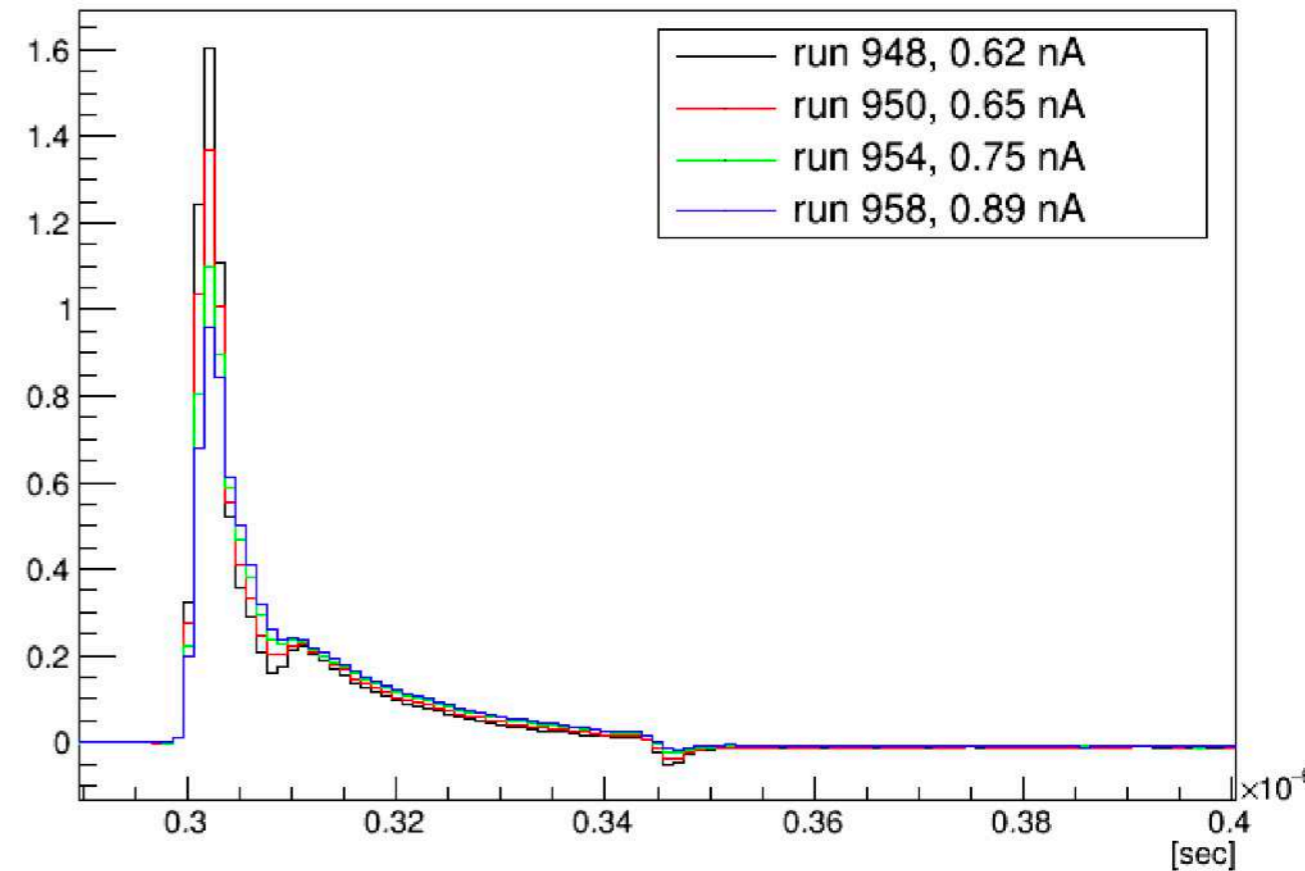

UV scan without attenuator and 10dB attenuator

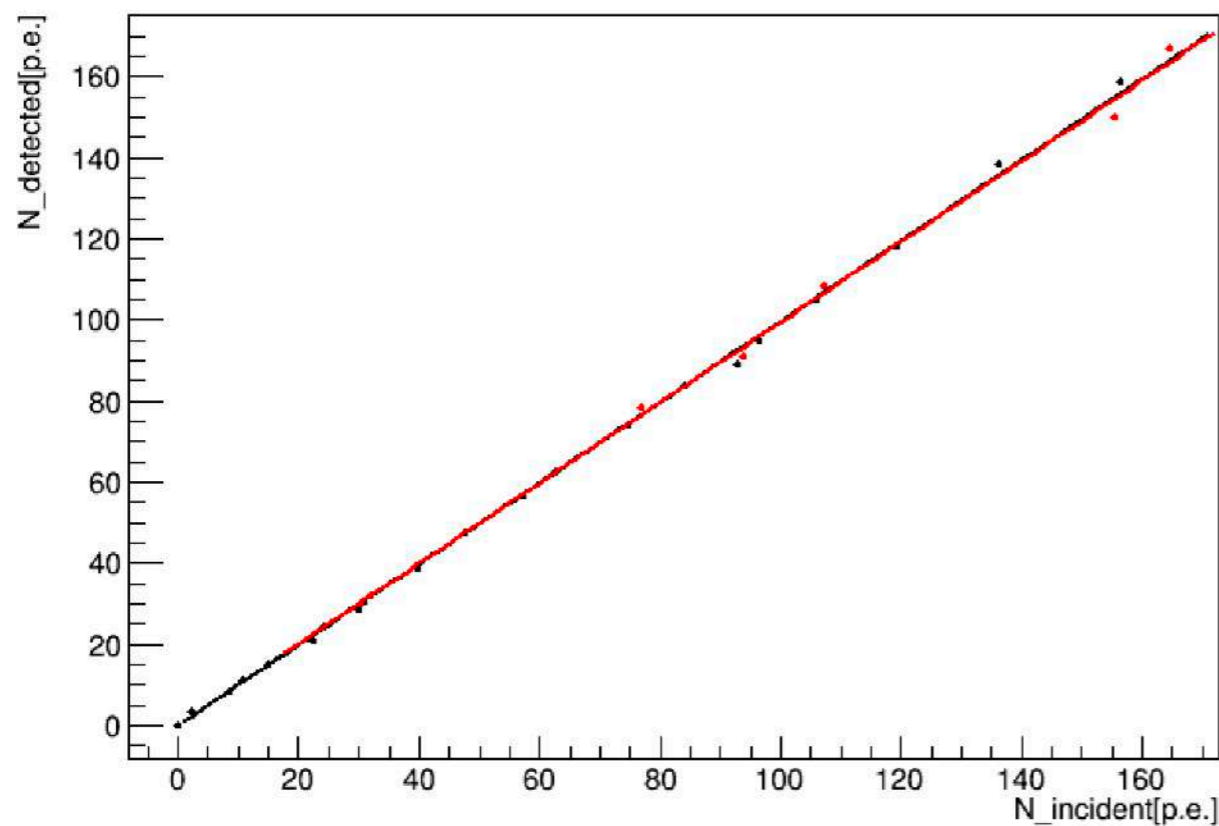

UV scan without attenuator and 10dB attenuator

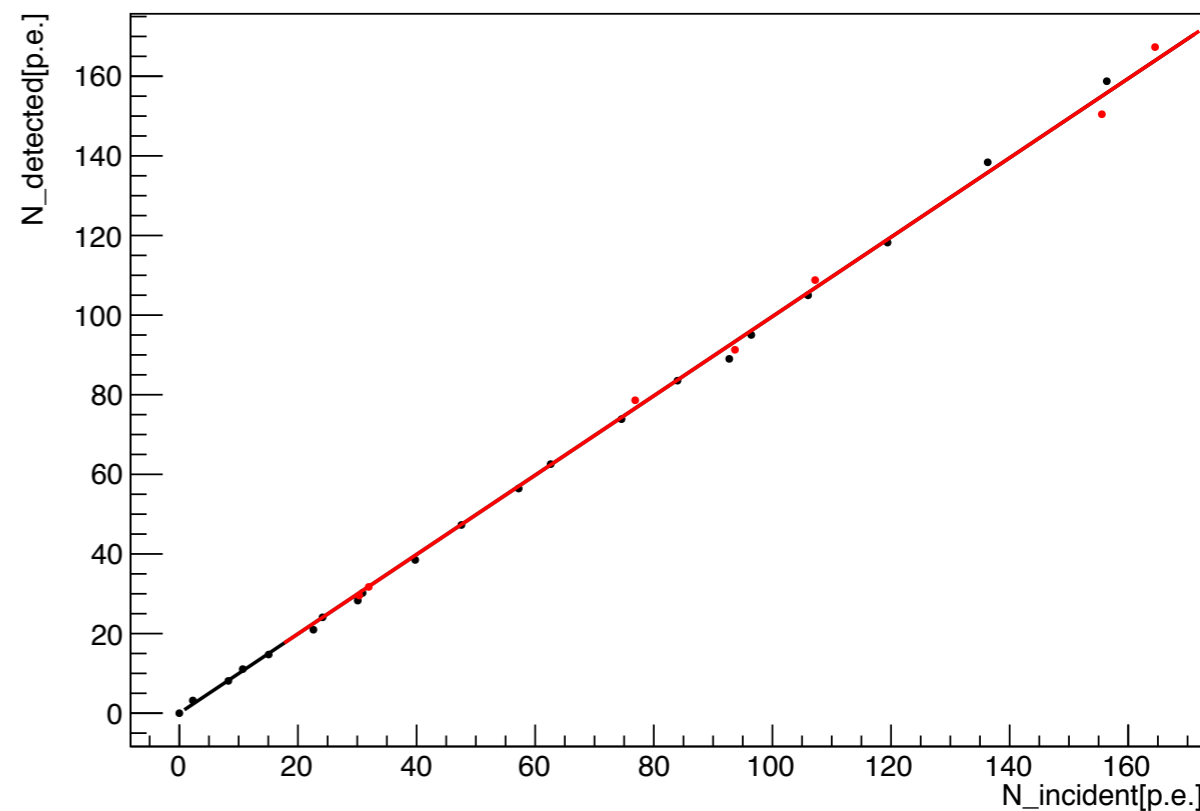

Waveforms with 10dB attenuator

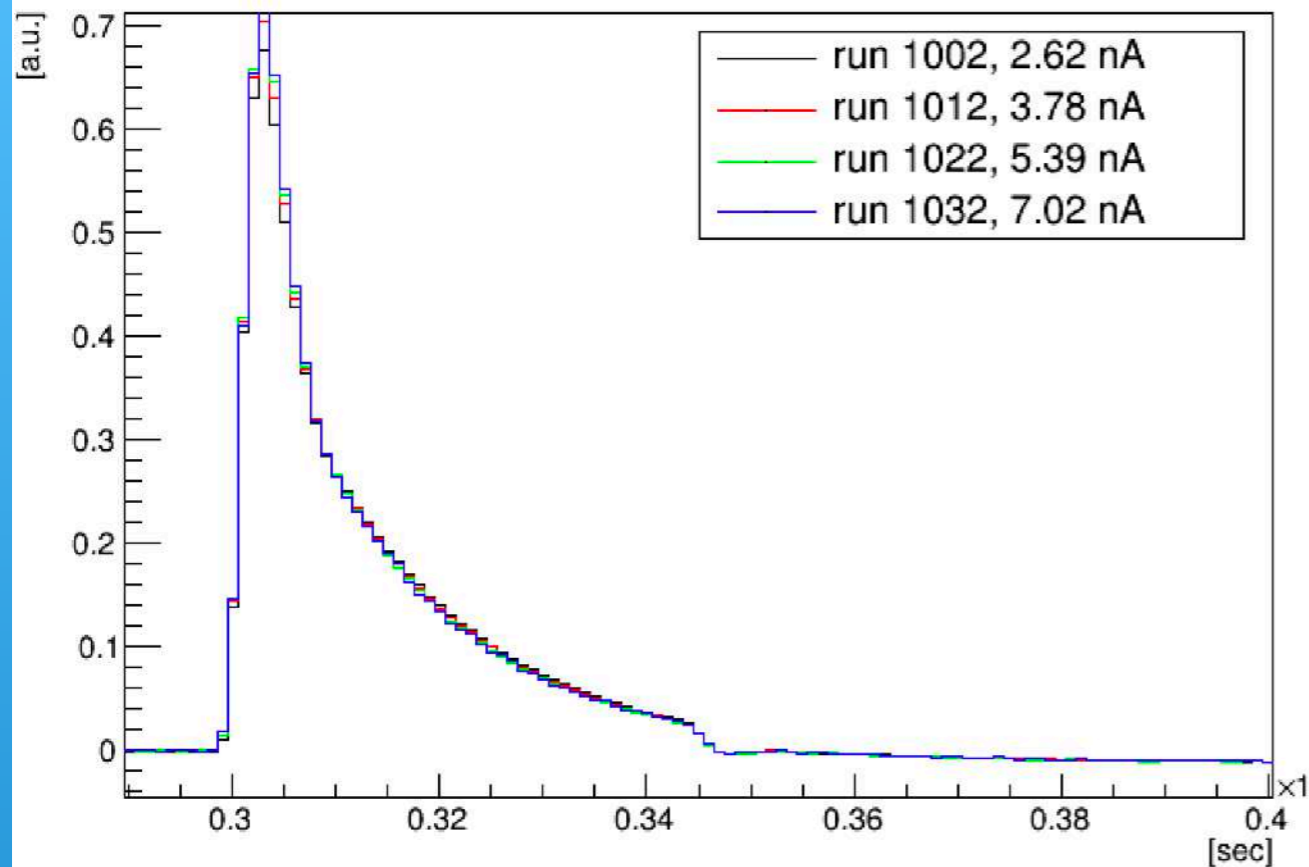

Waveforms with 30dB attenuator

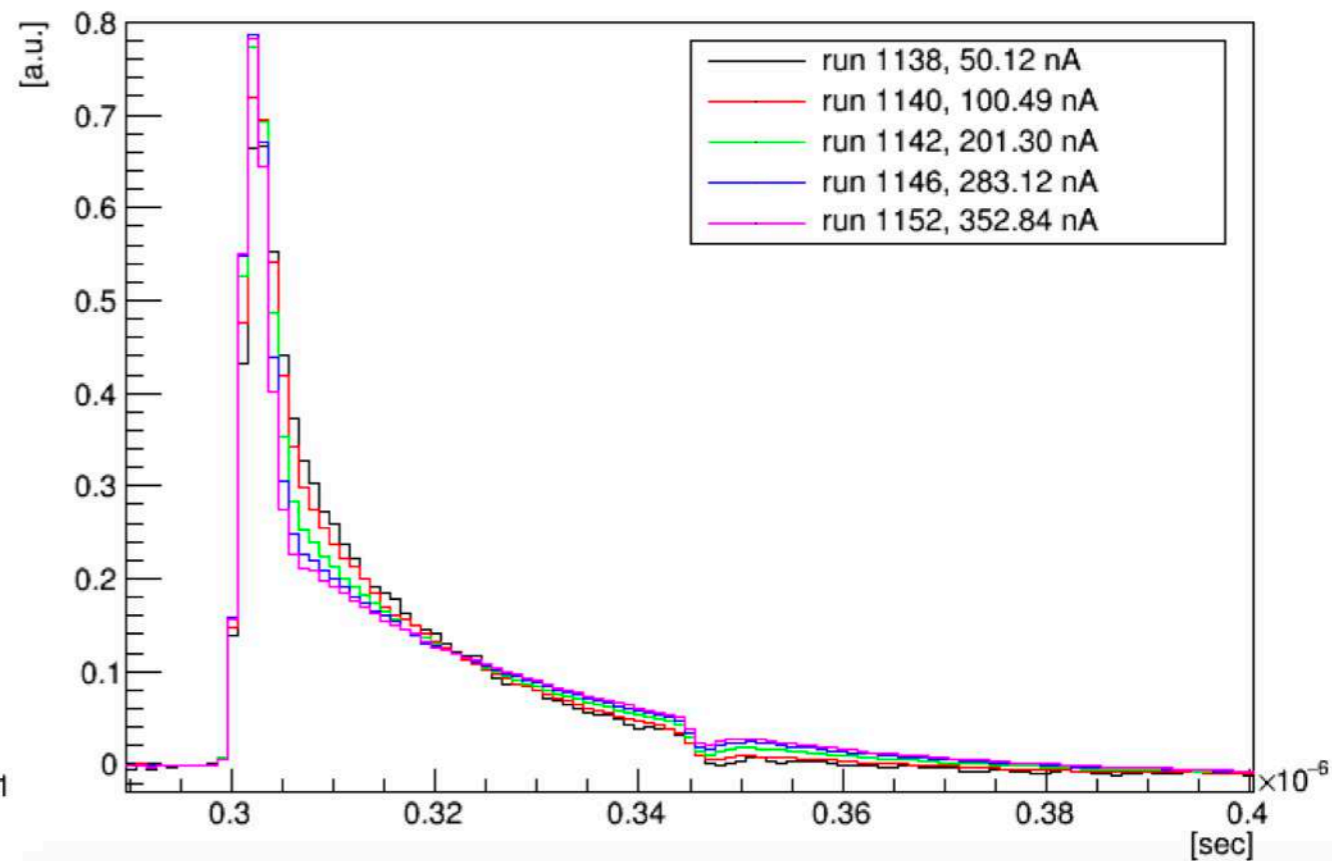

Waveforms with 40dB attenuator

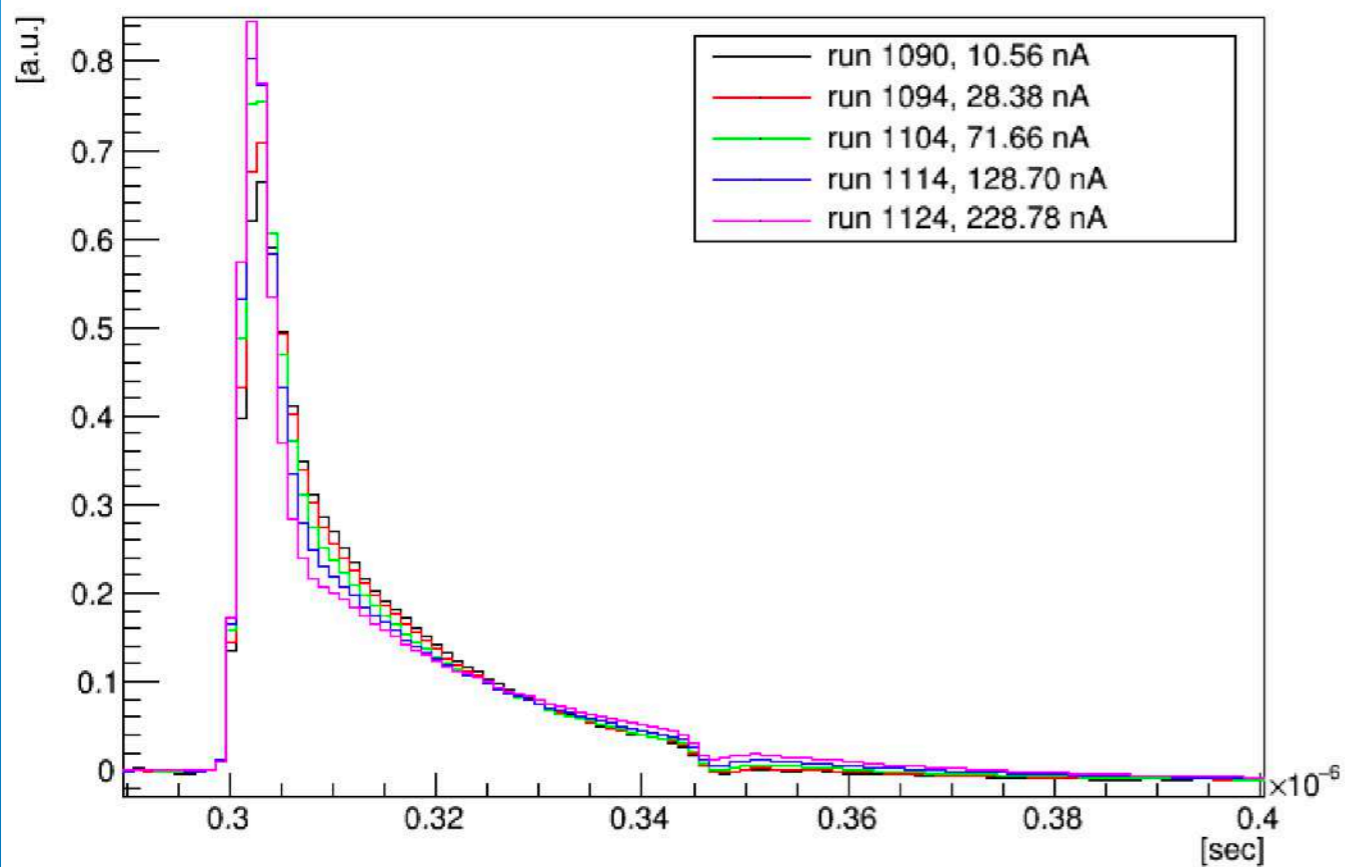

Waveform transition with 0 - 40dB attenuator

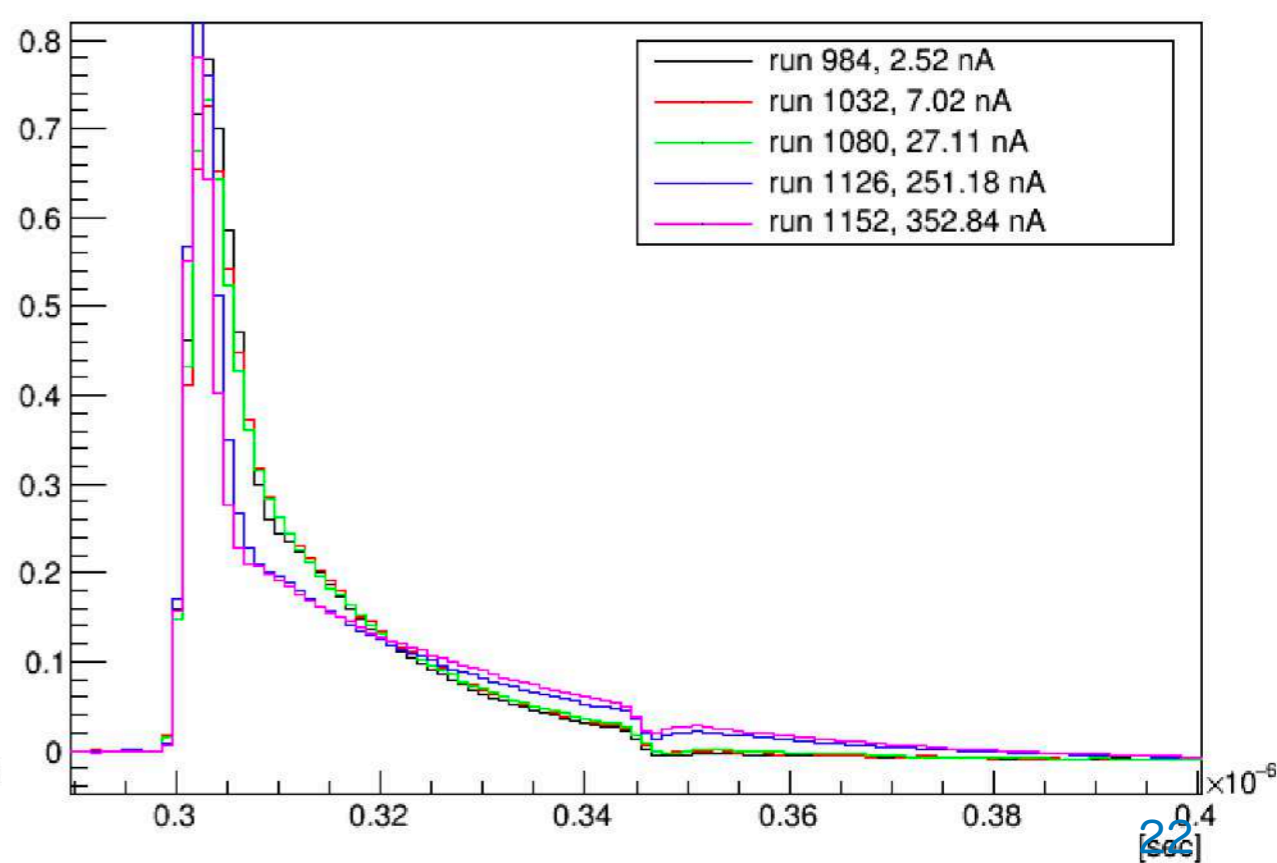

Attenuation factor 0dB vs. 10dB

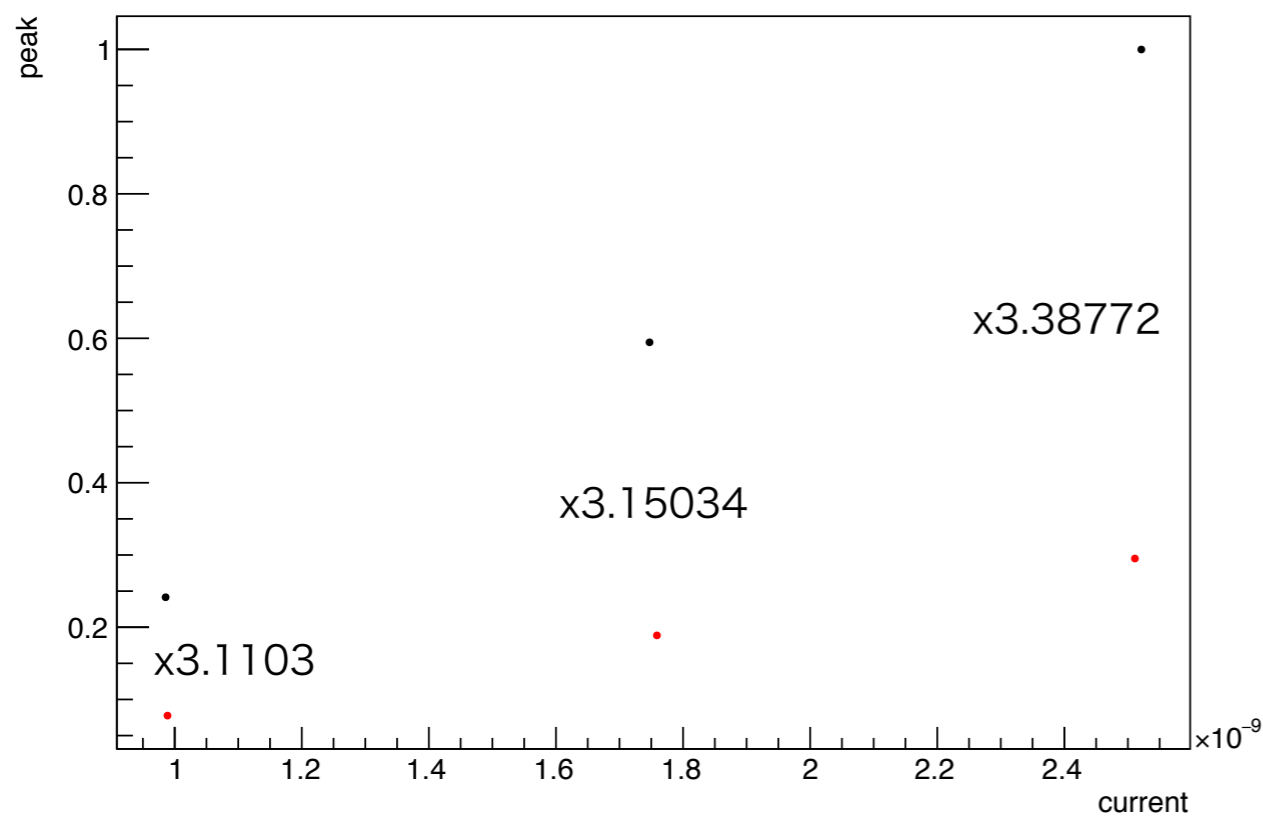

Attenuation factor 10dB vs. 20dB

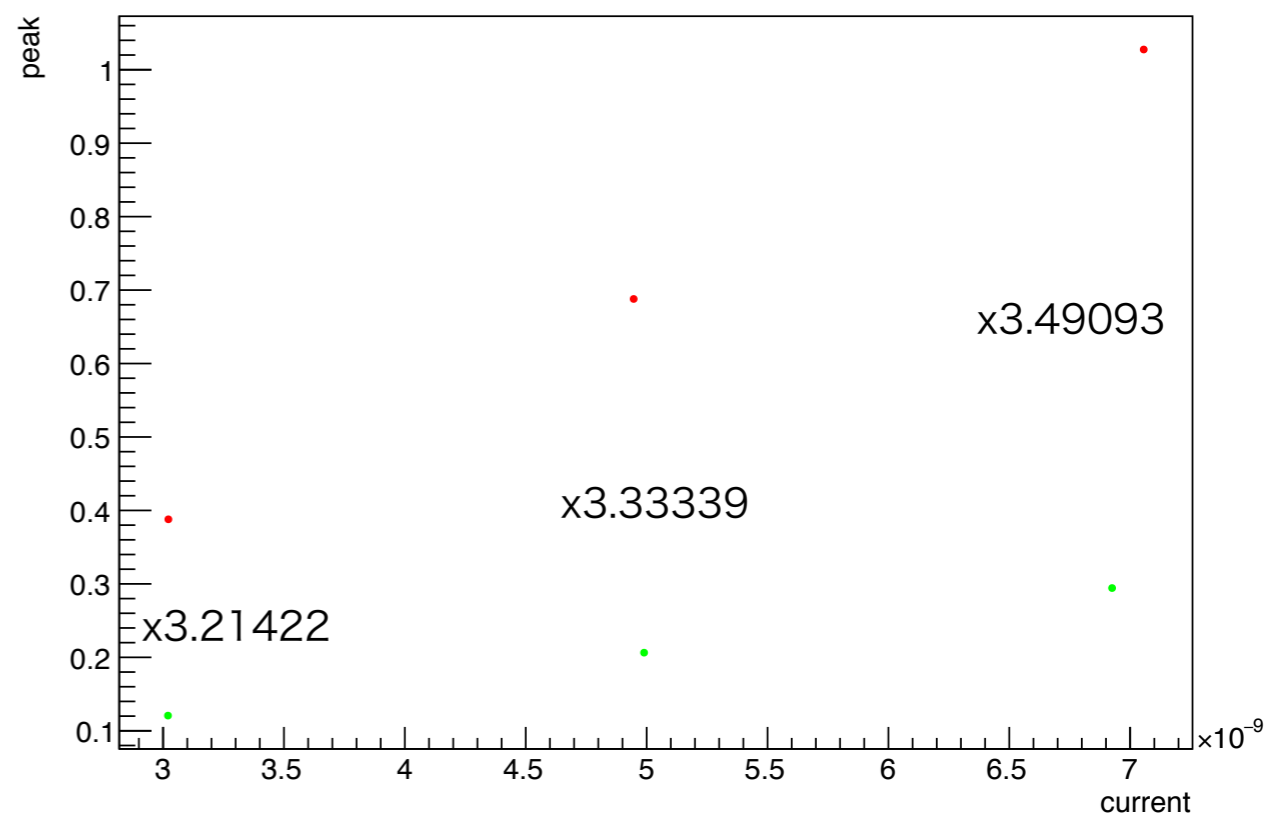

Attenuation factor 20dB vs. 30dB

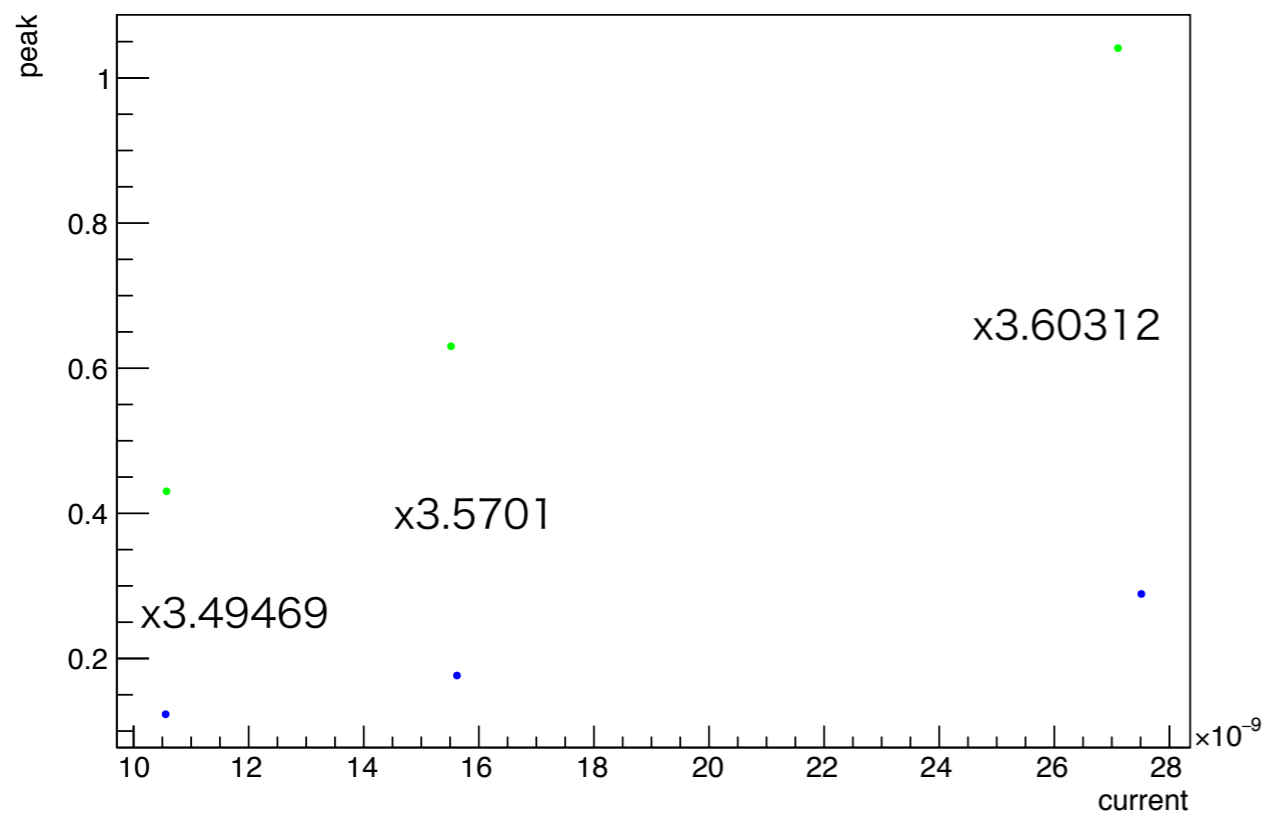

Attenuation factor 30dB vs. 40dB

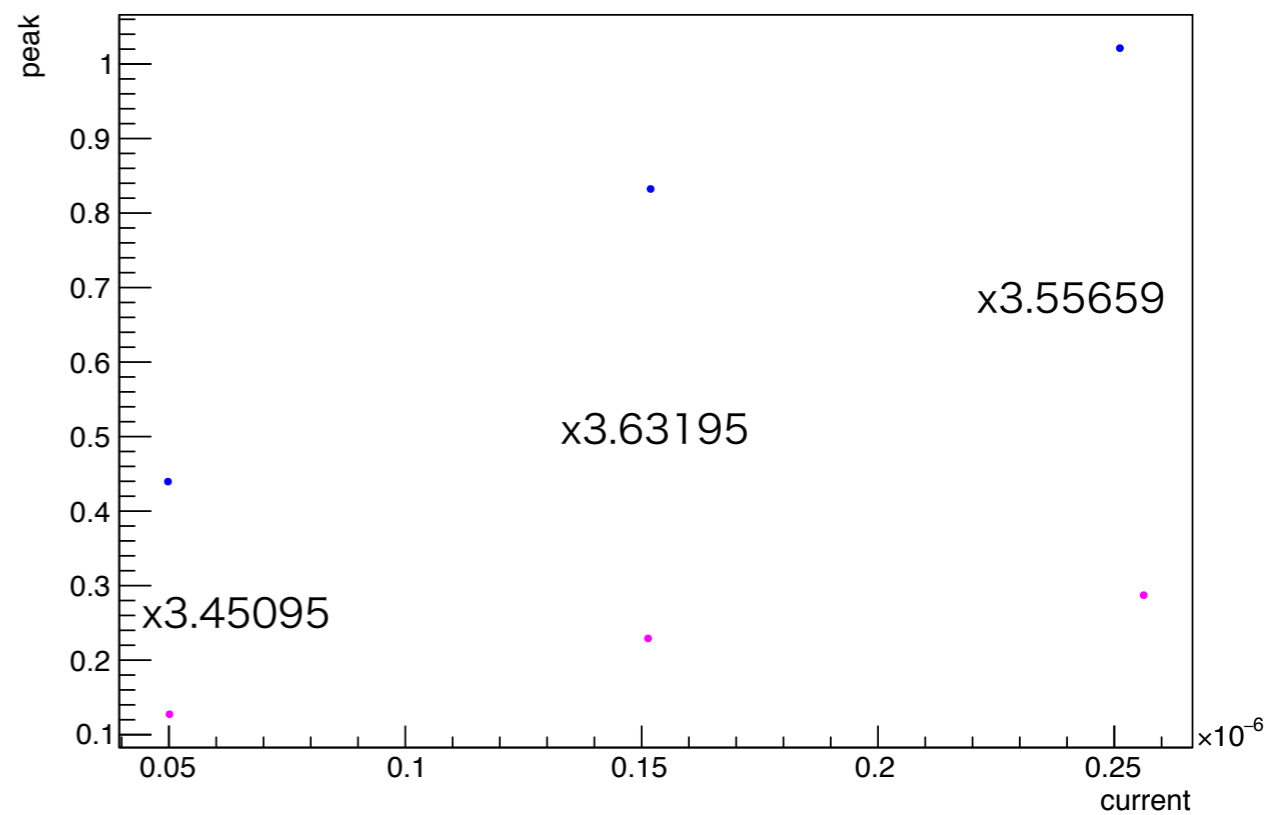

Attenuation factor 0dB vs. 10dB

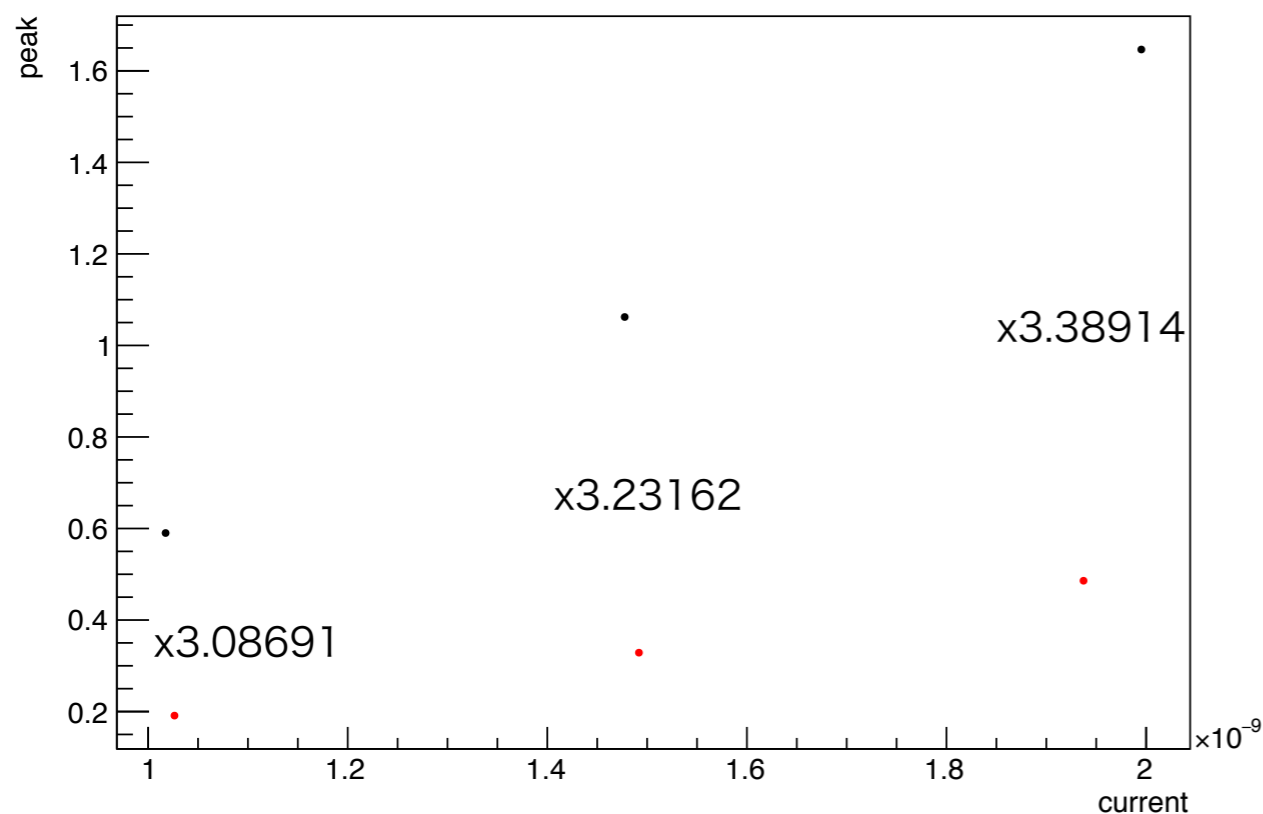

Waveforms with 0dB attenuator

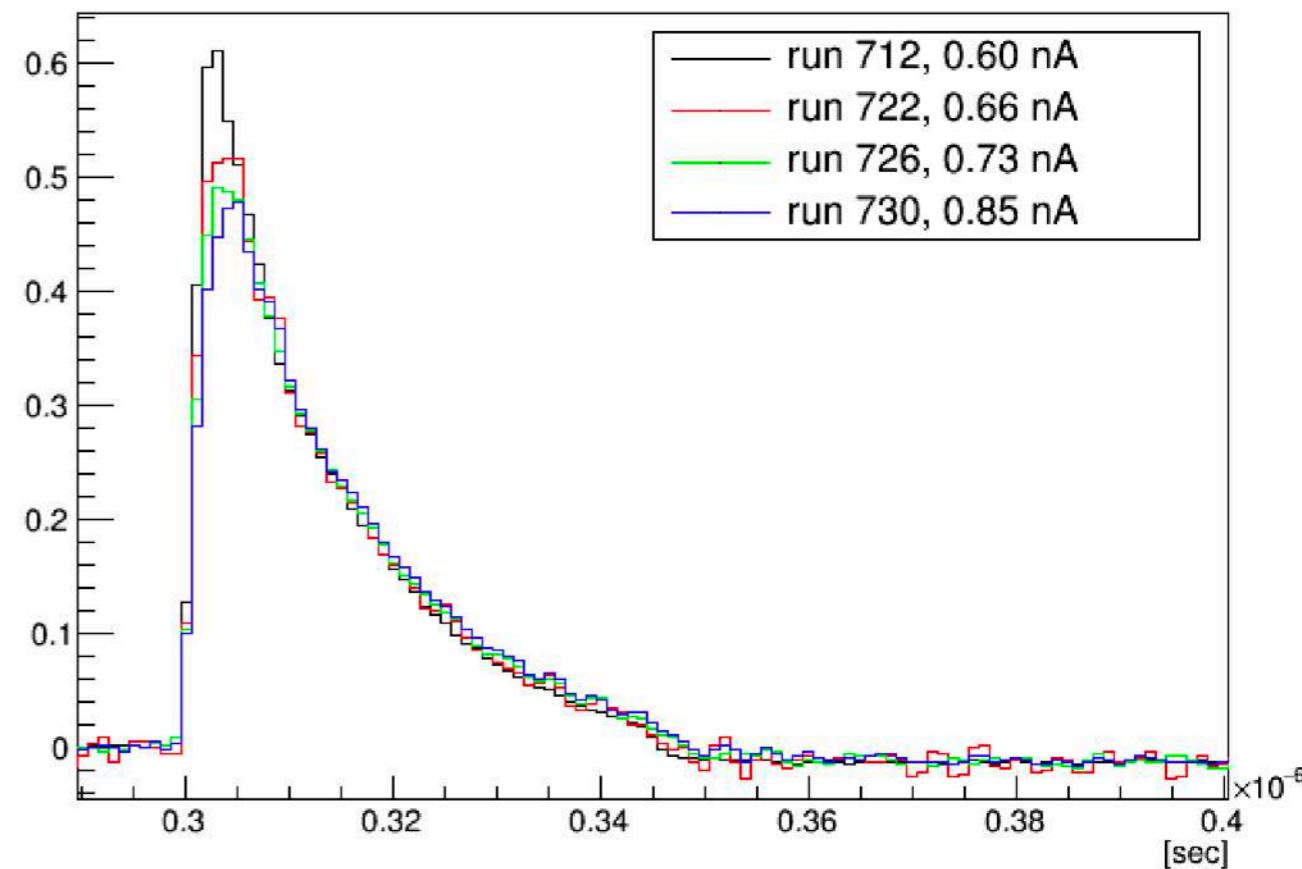

UV scan without attenuator and 10dB attenuator

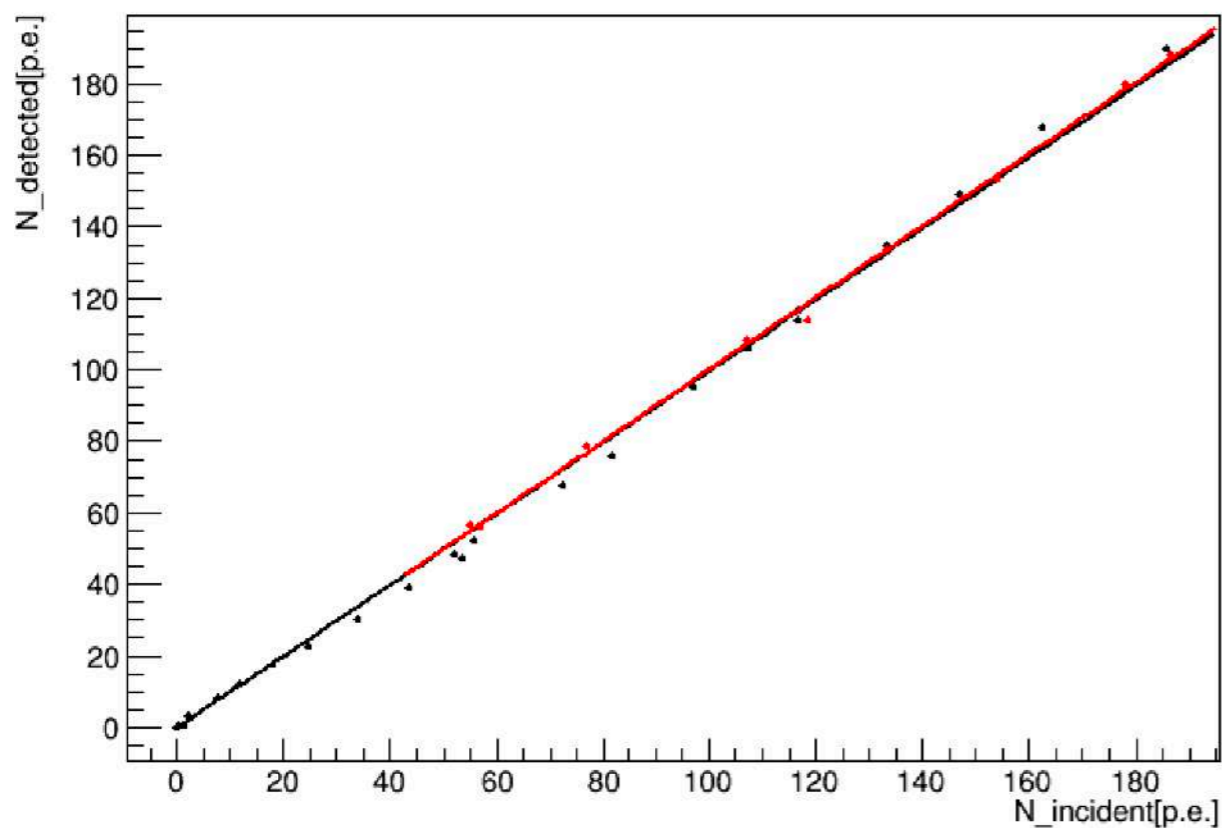

UV scan without attenuator and 10dB attenuator

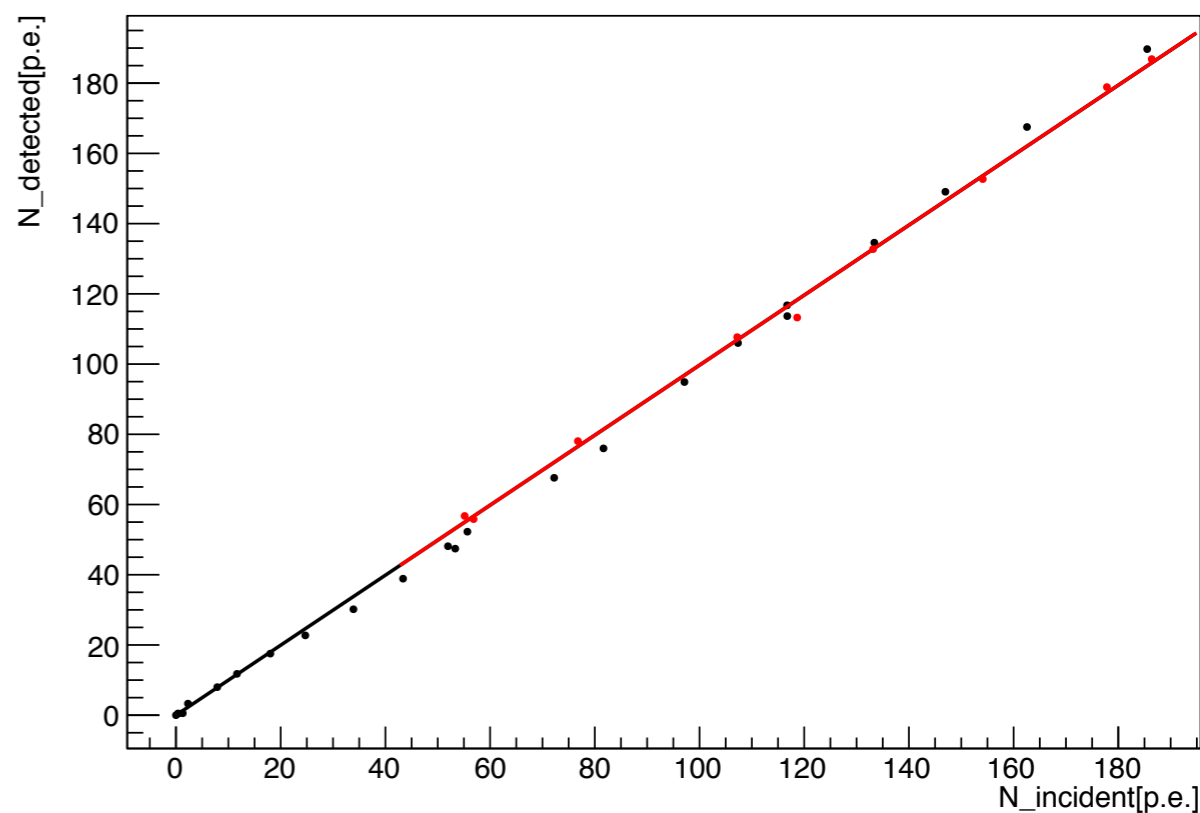

Waveforms with 10dB attenuator

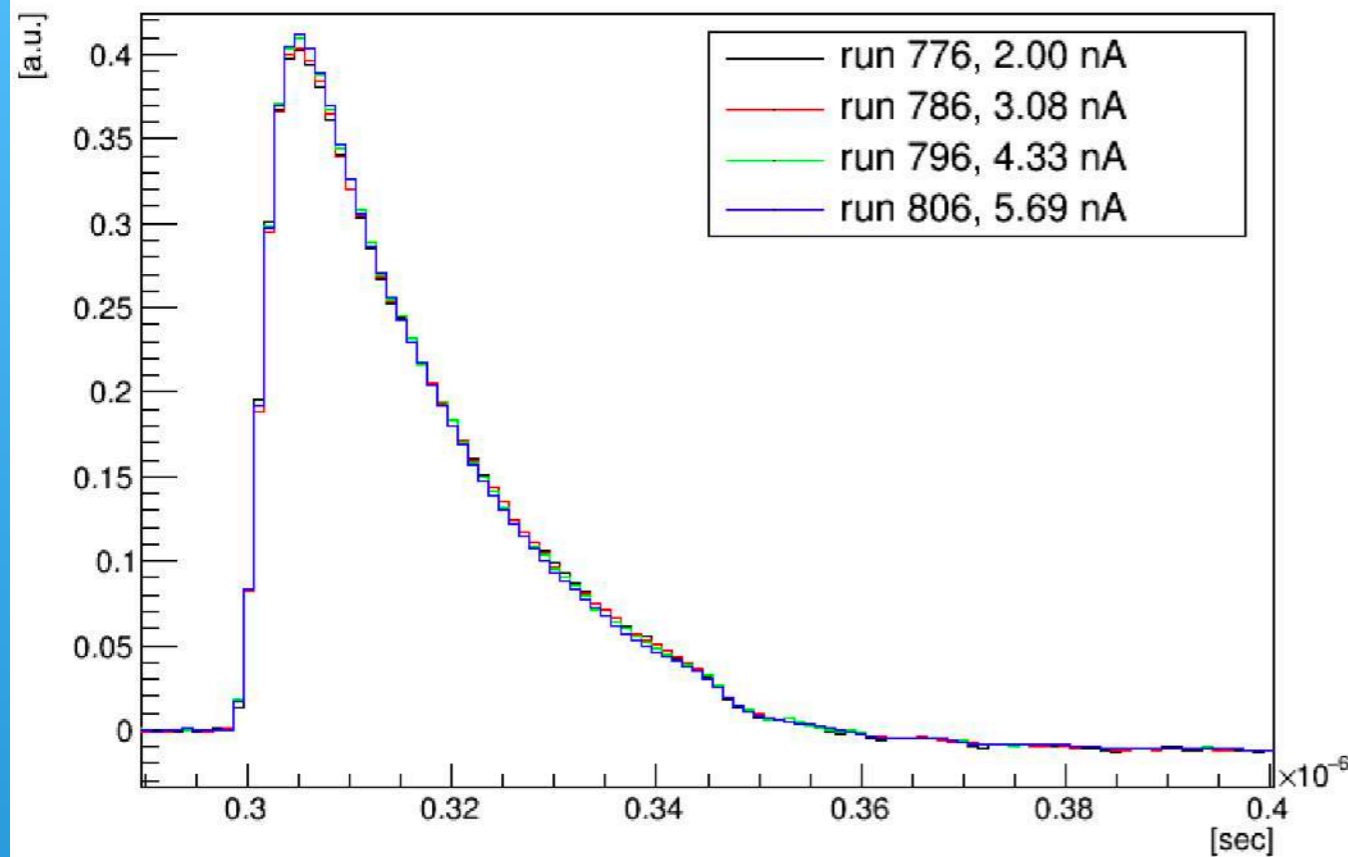

Waveforms with 30dB attenuator

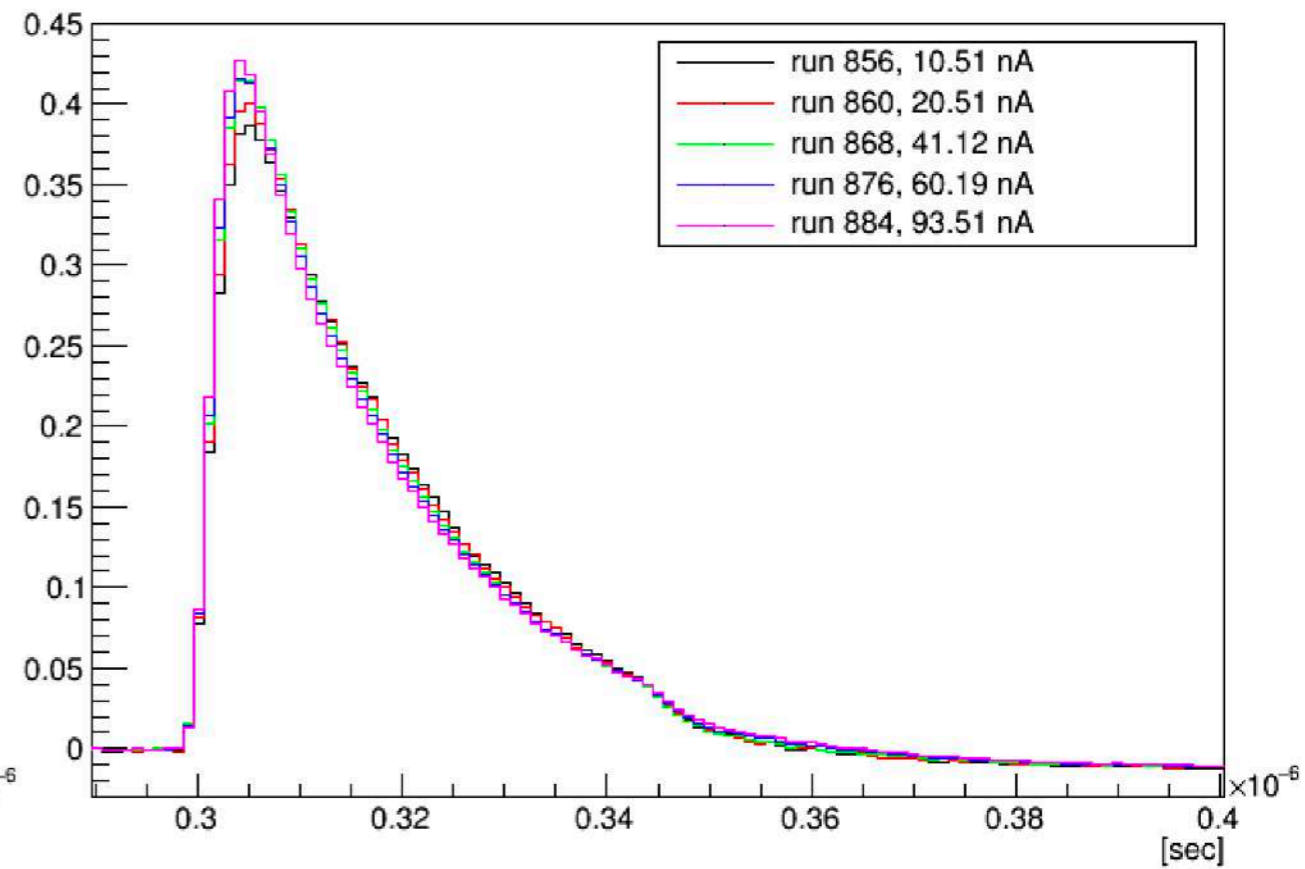

Waveforms with 40dB attenuator

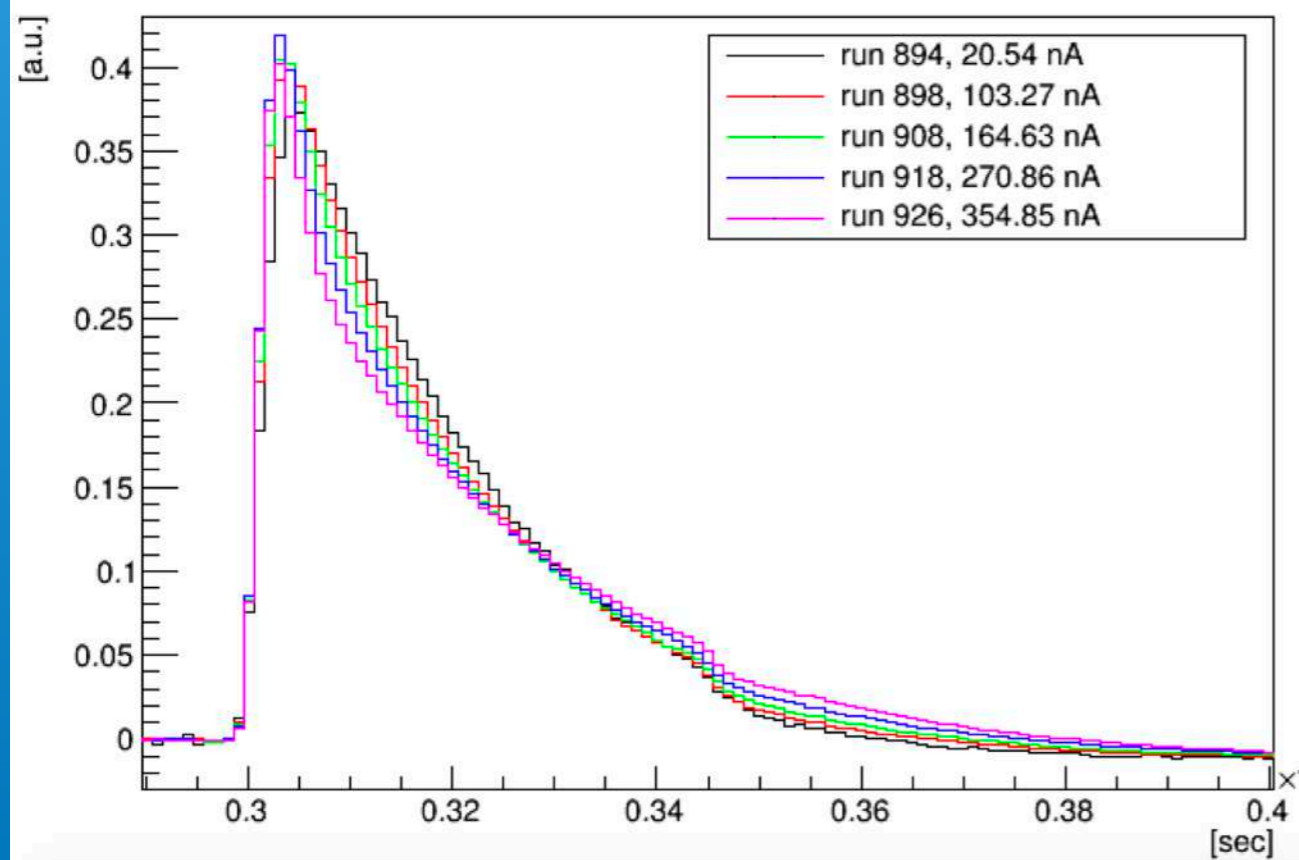

Waveform transition with 0 - 40dB attenuator

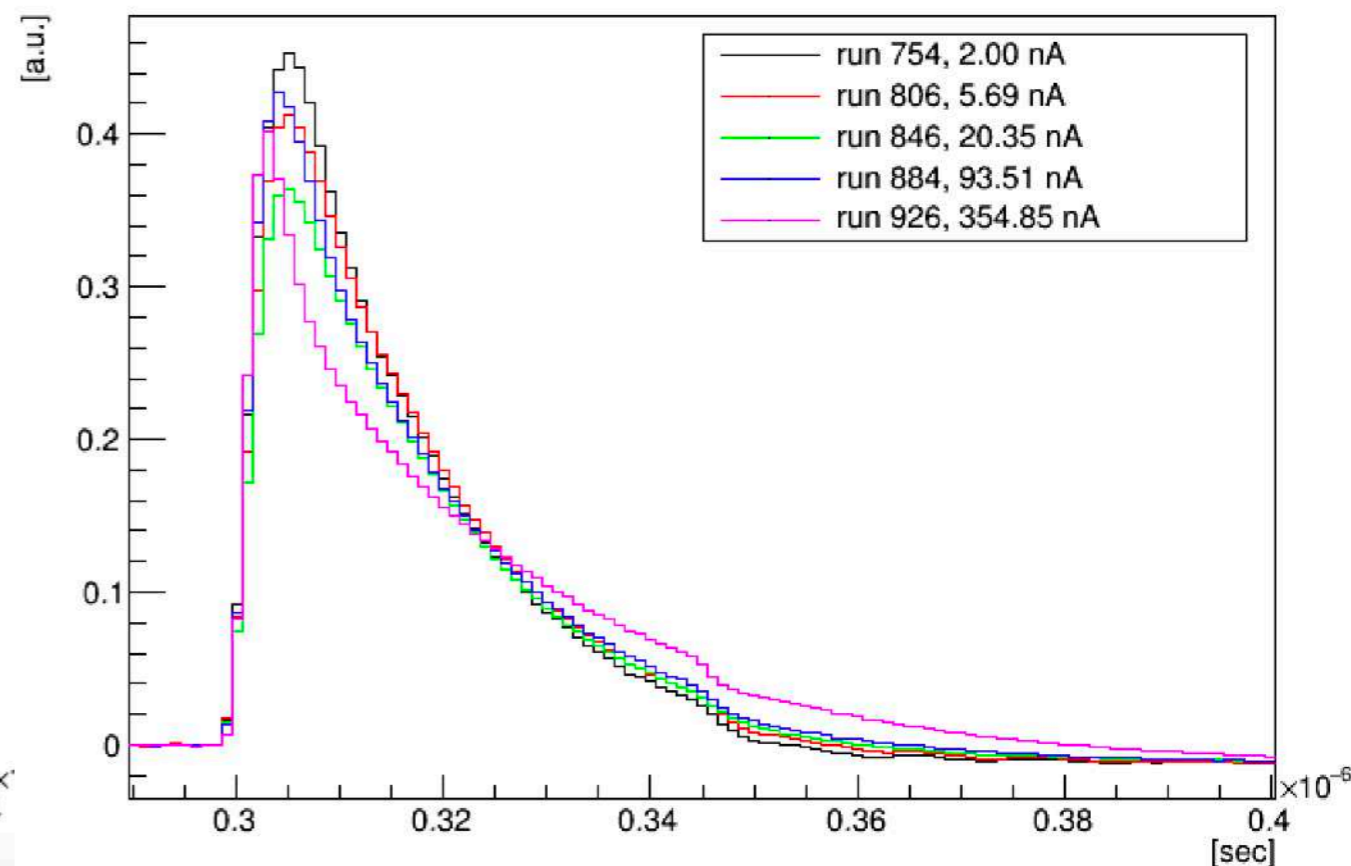

Attenuation factor 0dB vs. 10dB

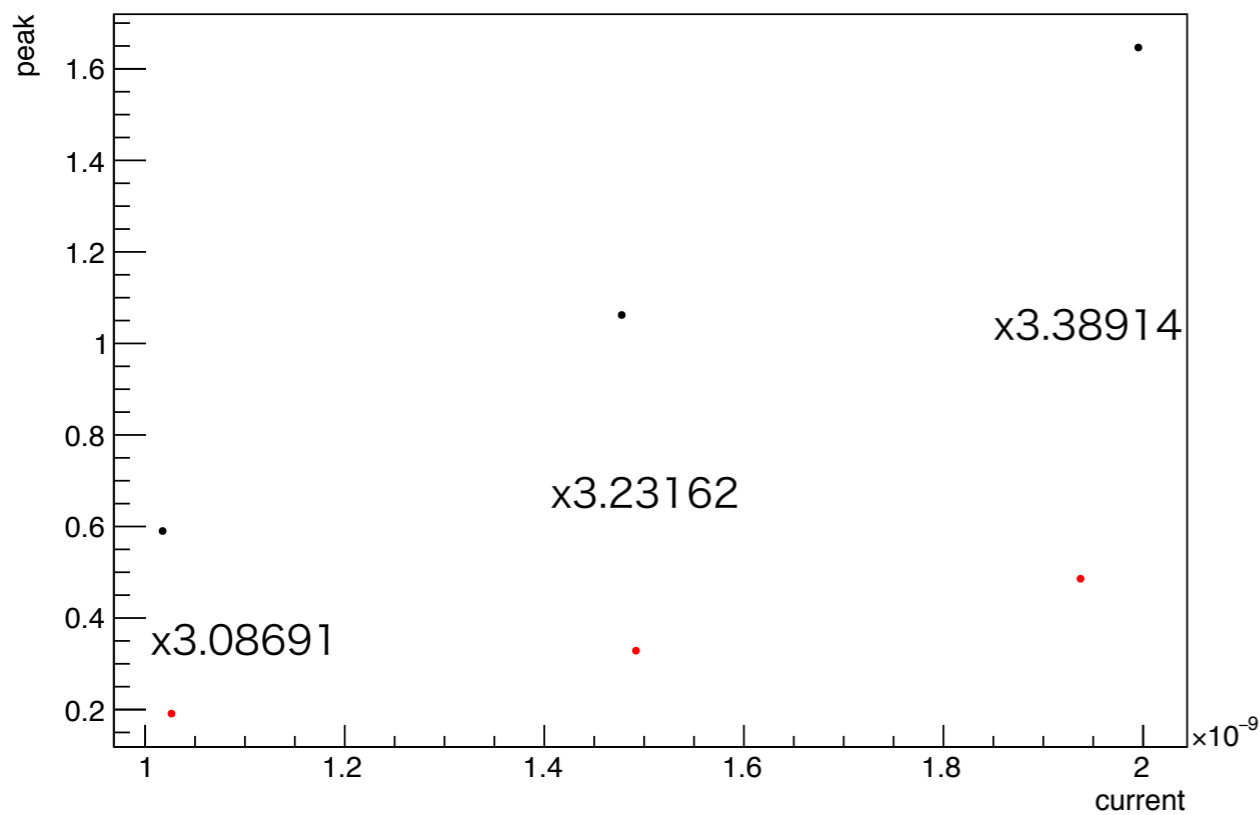

Attenuation factor 10dB vs. 20dB

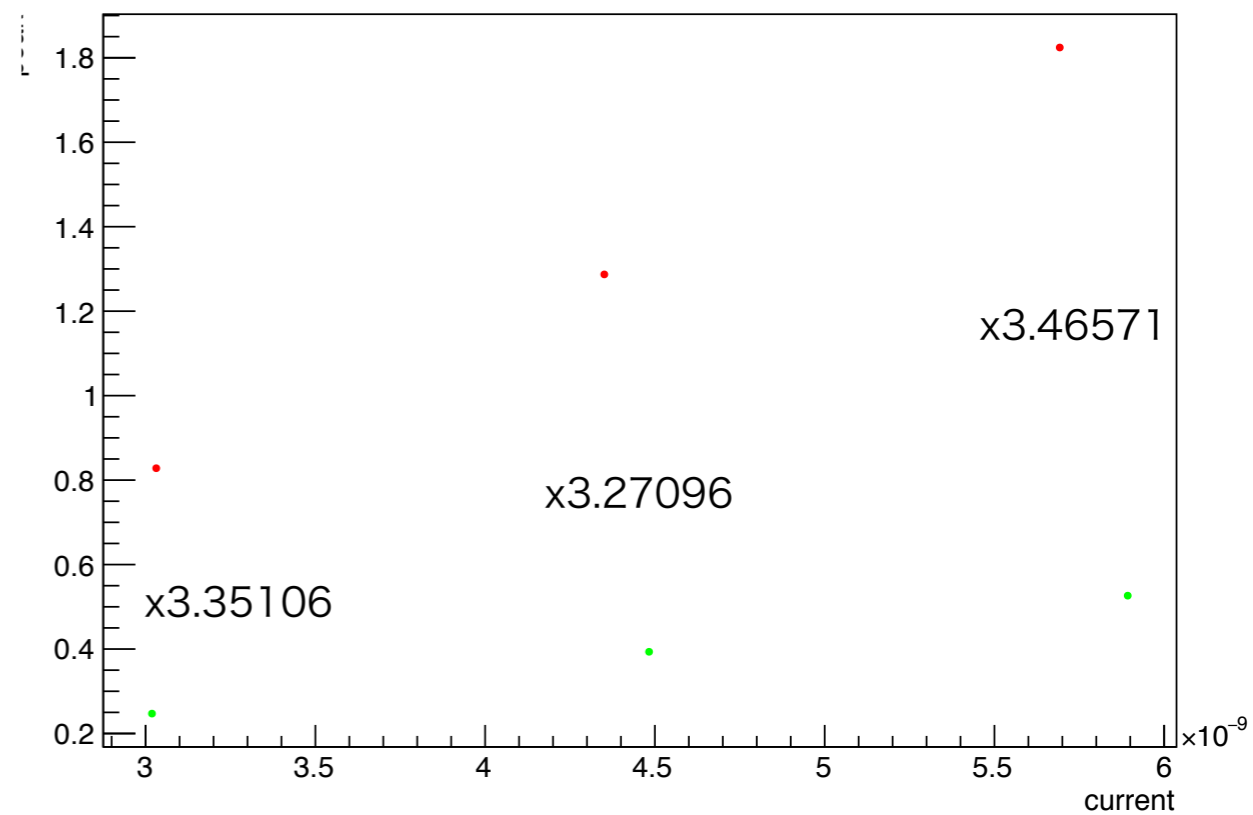

Attenuation factor 20dB vs. 30dB

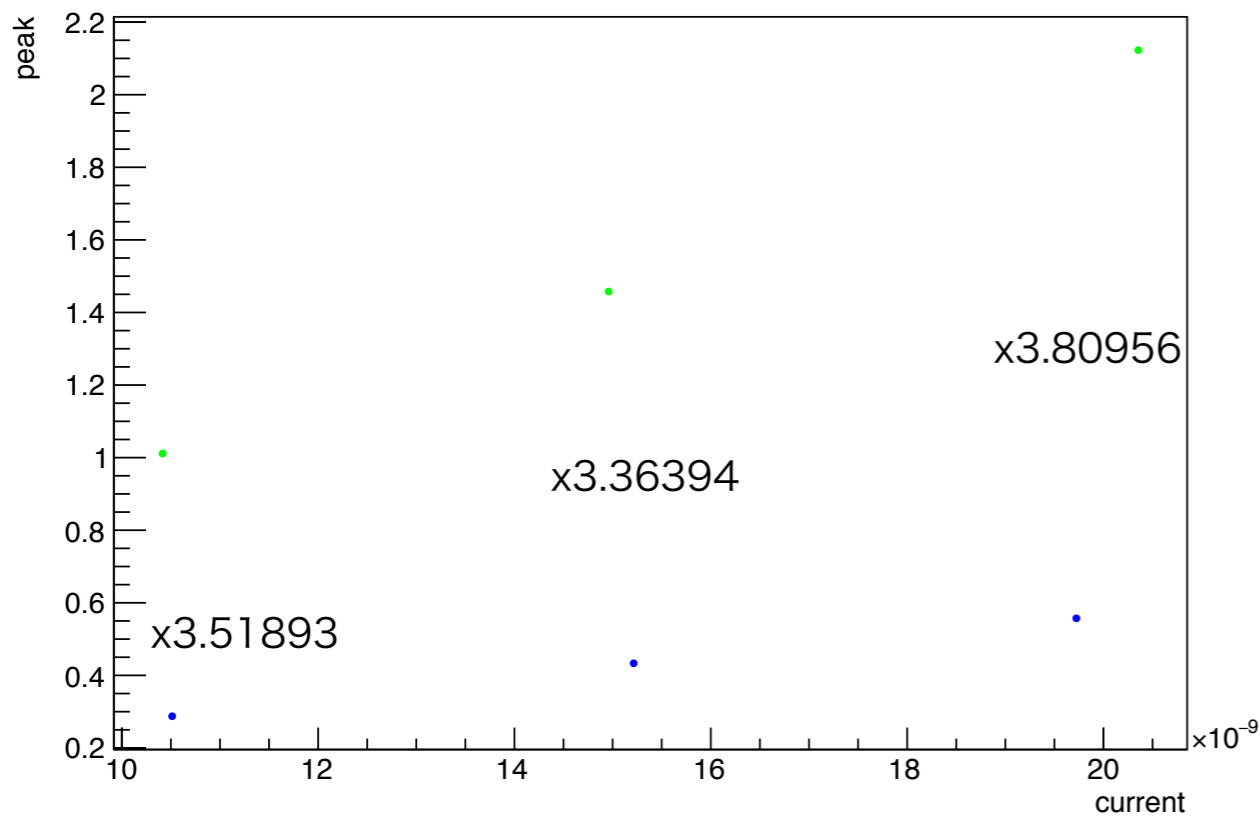

Attenuation factor 30dB vs. 40dB

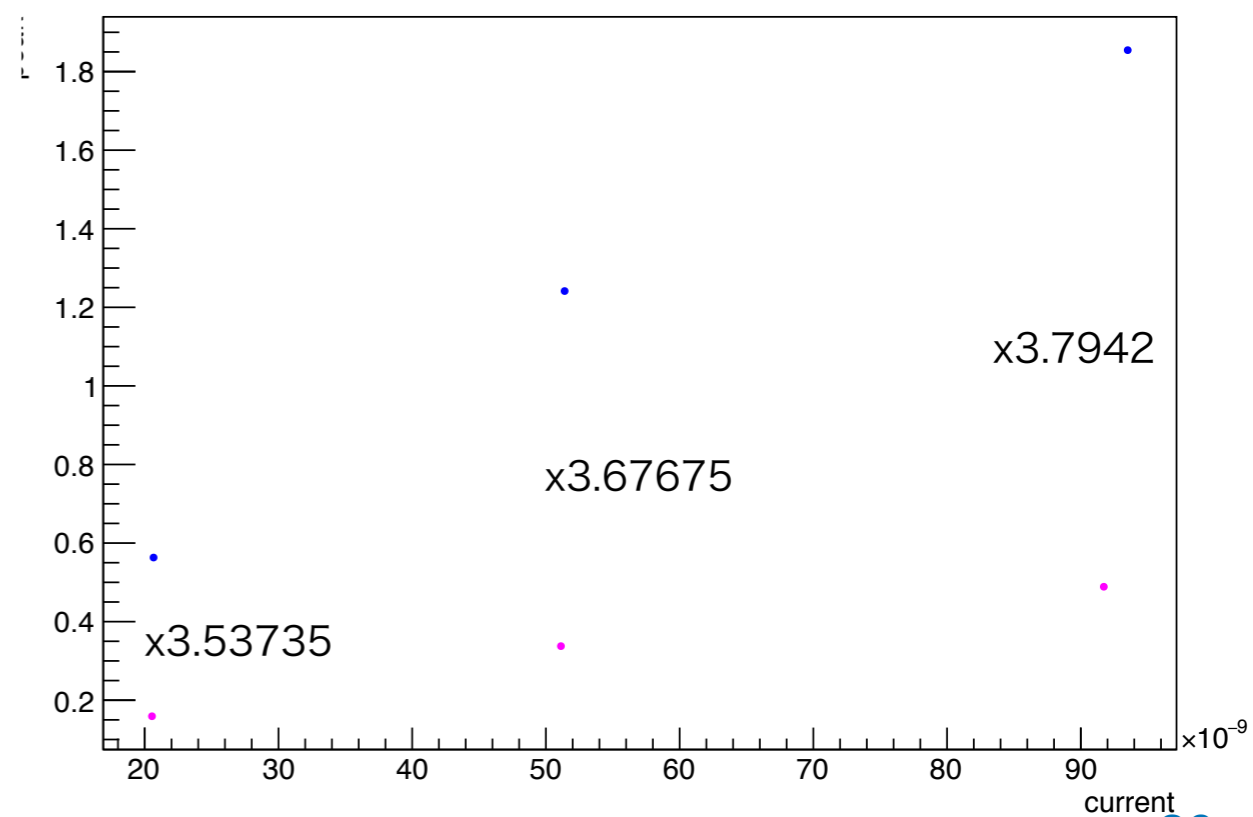

Comparison with two types of MPPCs

- The difference of two plots should be consistent with the difference of PDE
 - However, S14160-1315PS is less saturated compared with S12571-015P even after correction
- Need further verification
 - We plan to do the same measurement with fast 400 nm laser

UV comparison of MPPCs

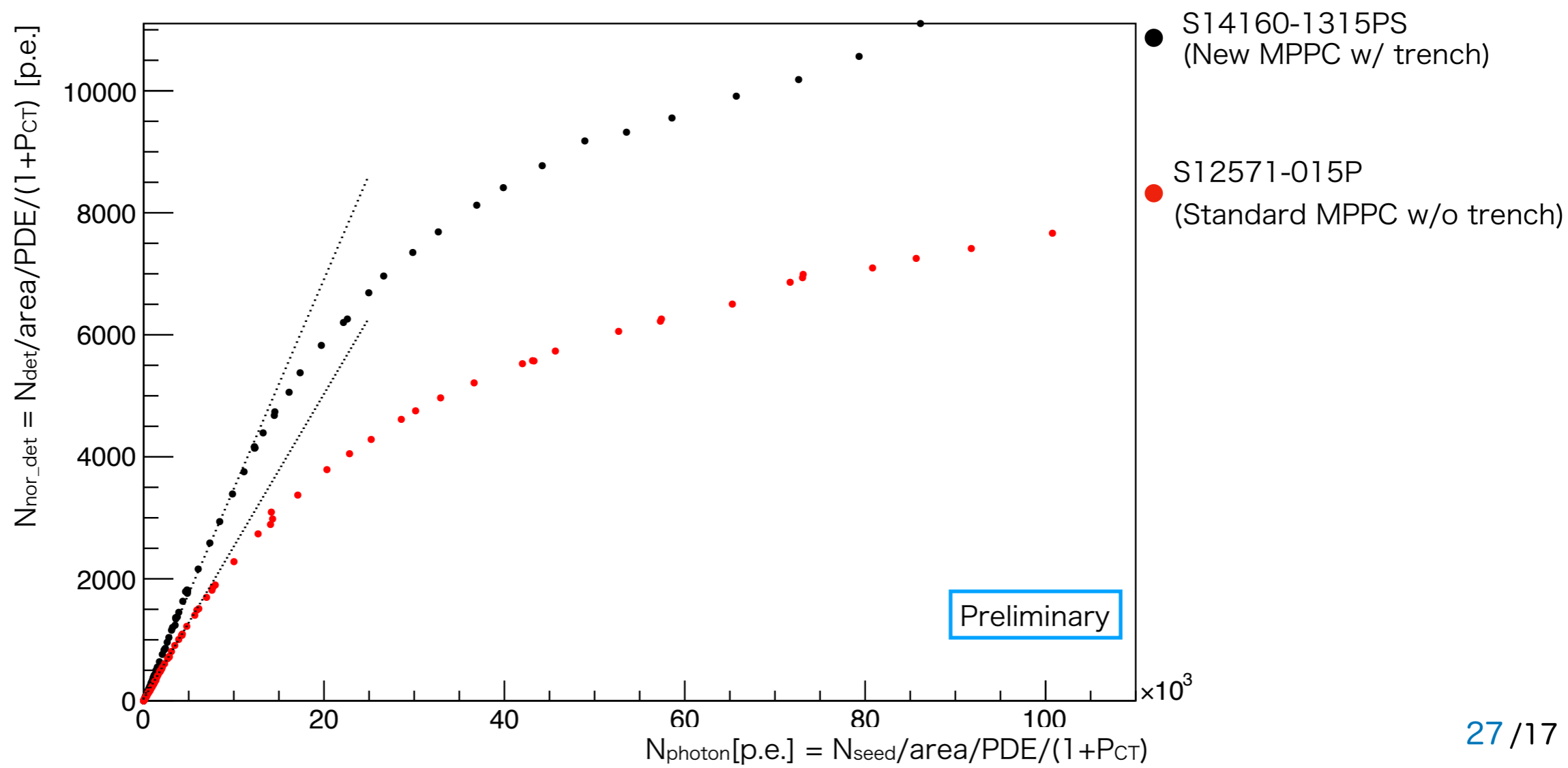

Waveform comparison with similar charge

SPX Template Waveform 000 : 41821 pulses used

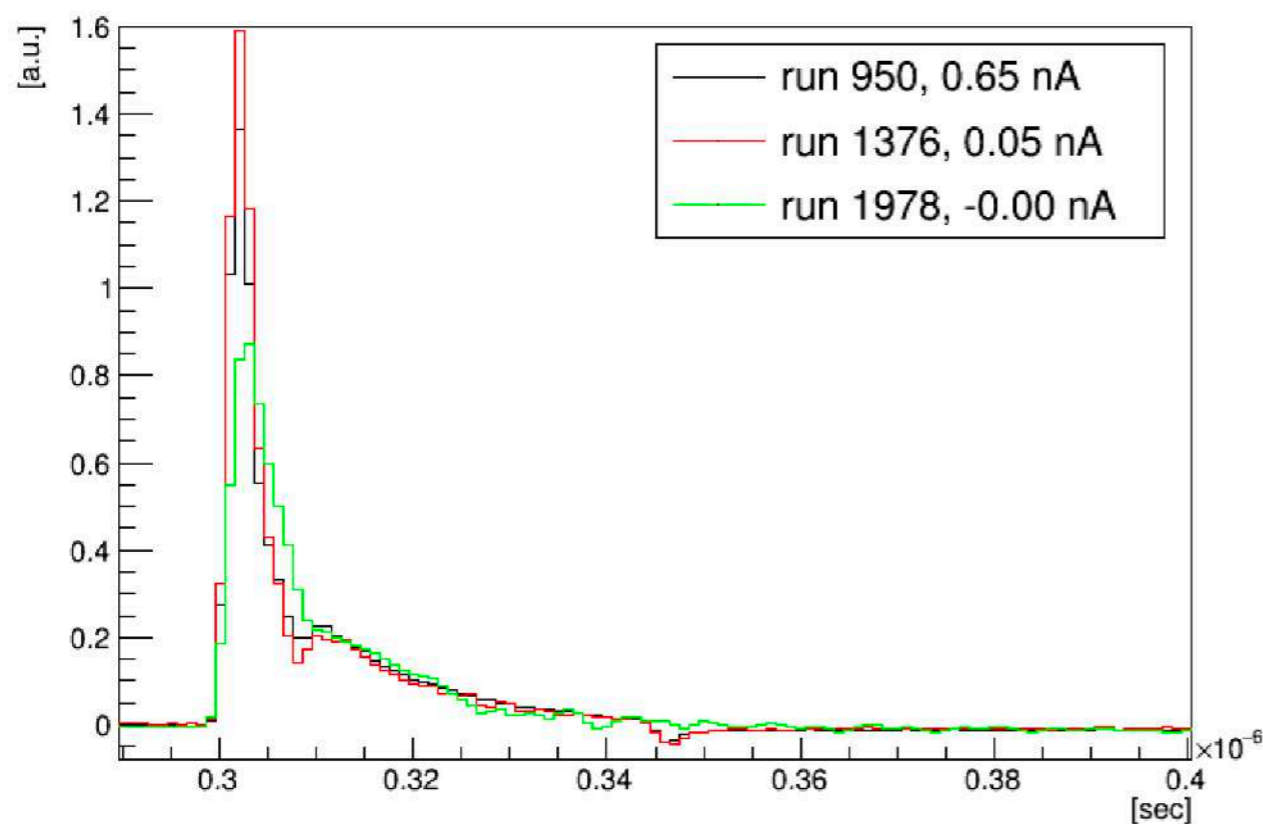

SPX Template Waveform 000 : 43327 pulses used

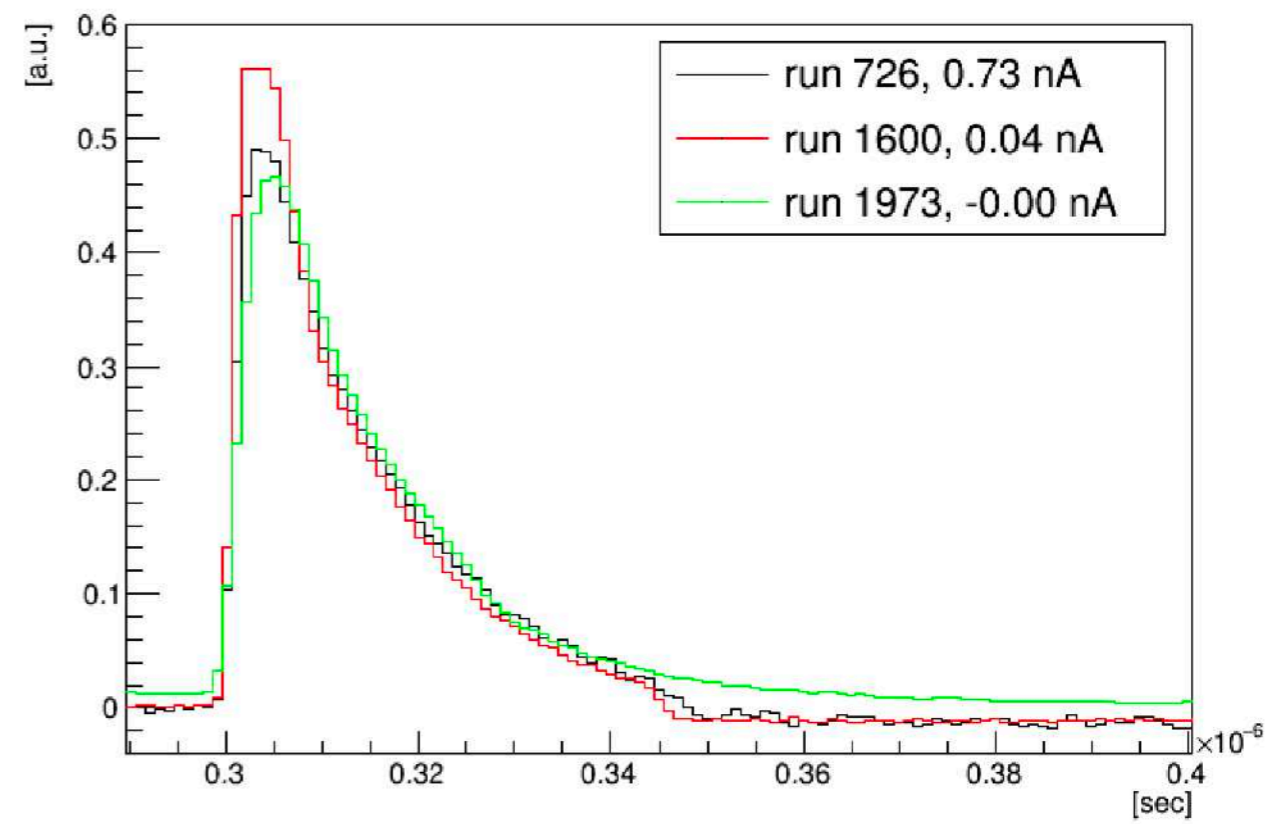

Comparison with previous study

- Comparing the measured saturation of S12571-015P with the previous study where fast laser is directly injected to MPPC
- **Saturation recovery observed**

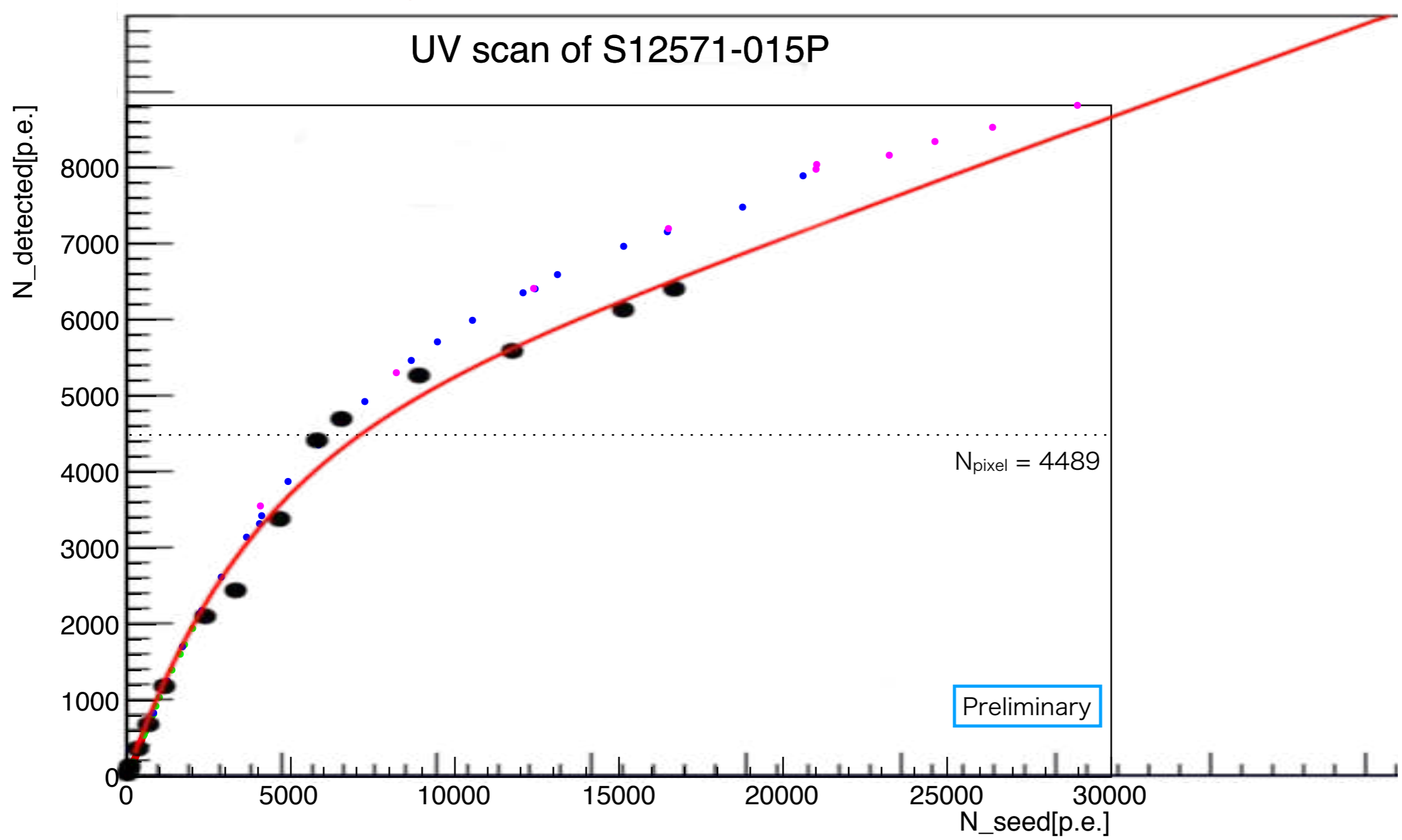



Dark count rate & Crosstalk probability

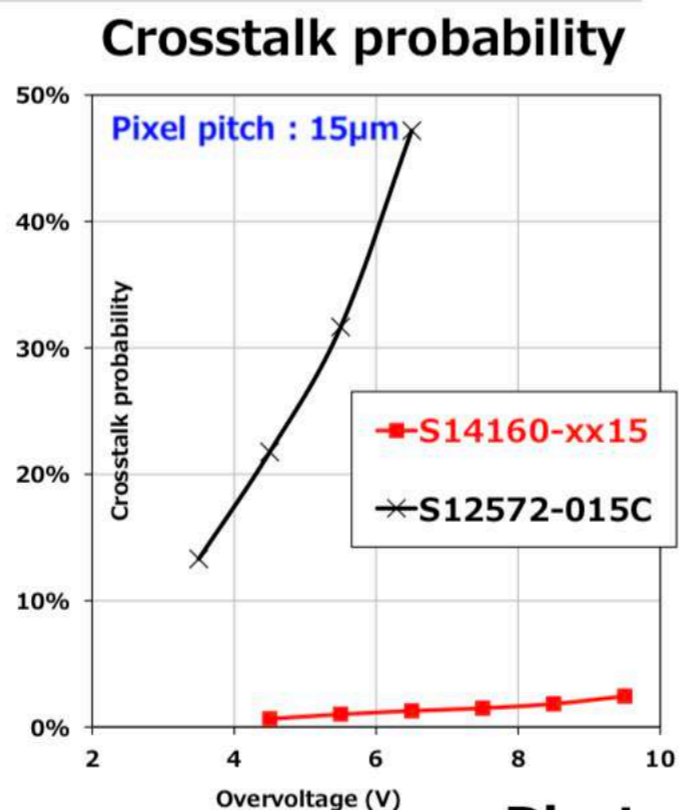
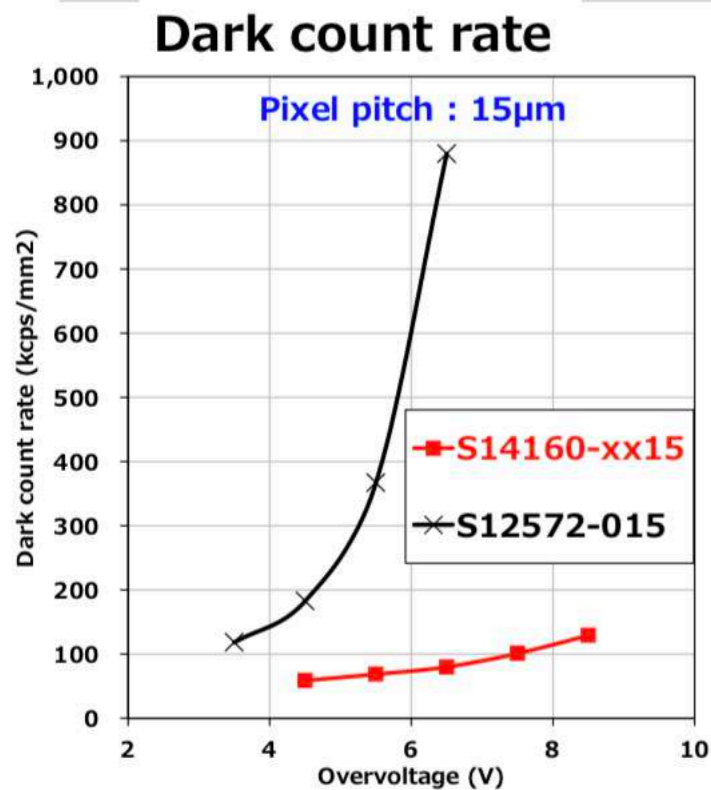

Photon detection efficiency(PDE)



PDE vs. Wavelength

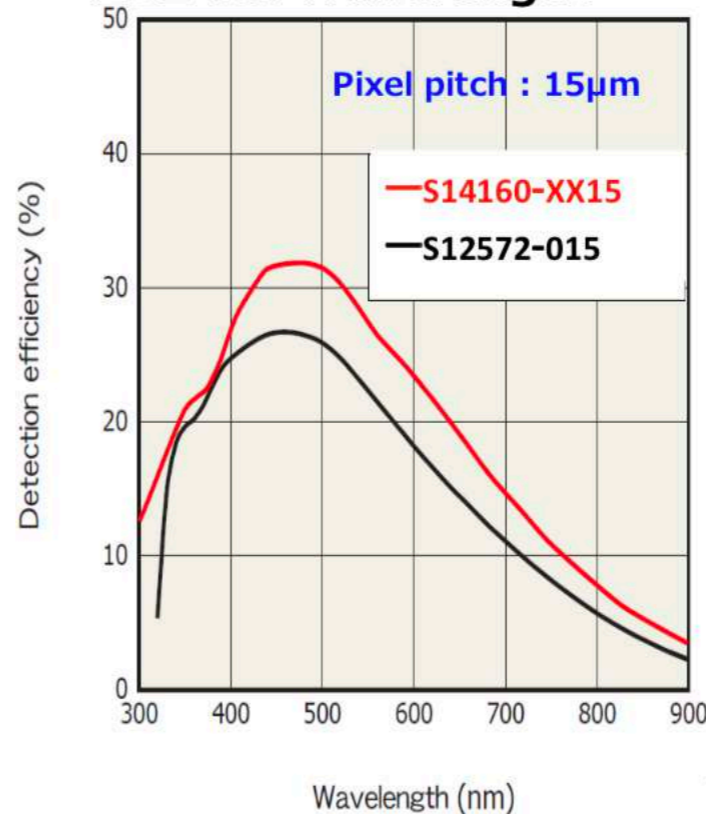

PDE vs. Overvoltage

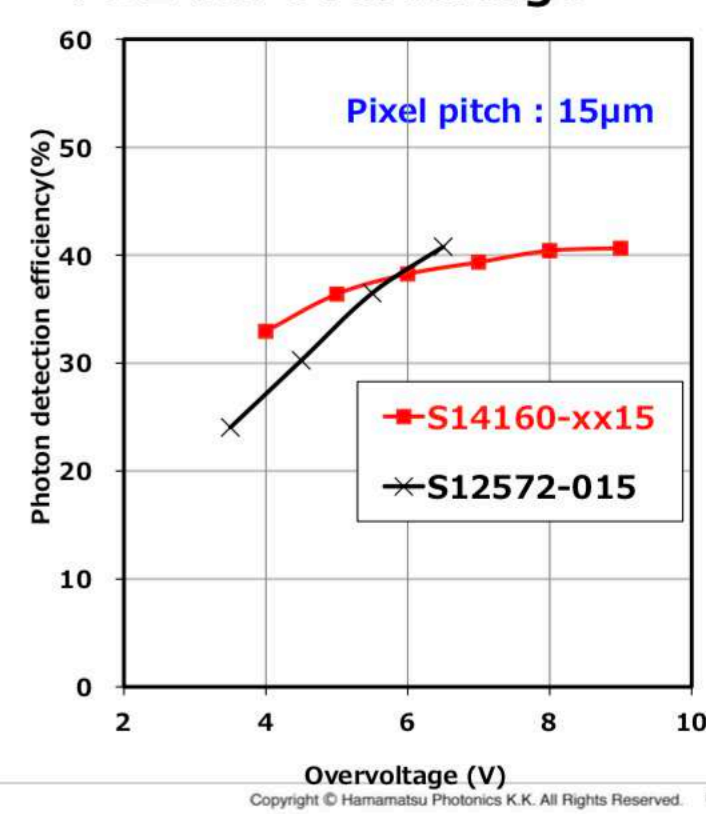

崔卒論

- レーザー光をPMTとMPPCに分割して測定
- レーザーからの信号の分割にはガラス板を使用
- この実験ではシンチを通してMPPCに入射

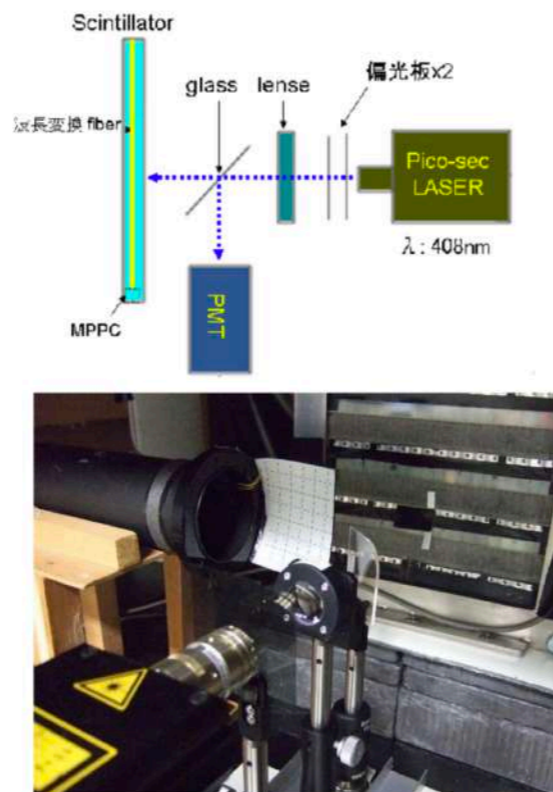

Set up

- 崔さんのセットアップで測定しようとしたが予定を変更
- レーザーの光をWLSF経由でMPPCとPMTに送る
- MPPCのレンジの確保のため、アッテネータを使用

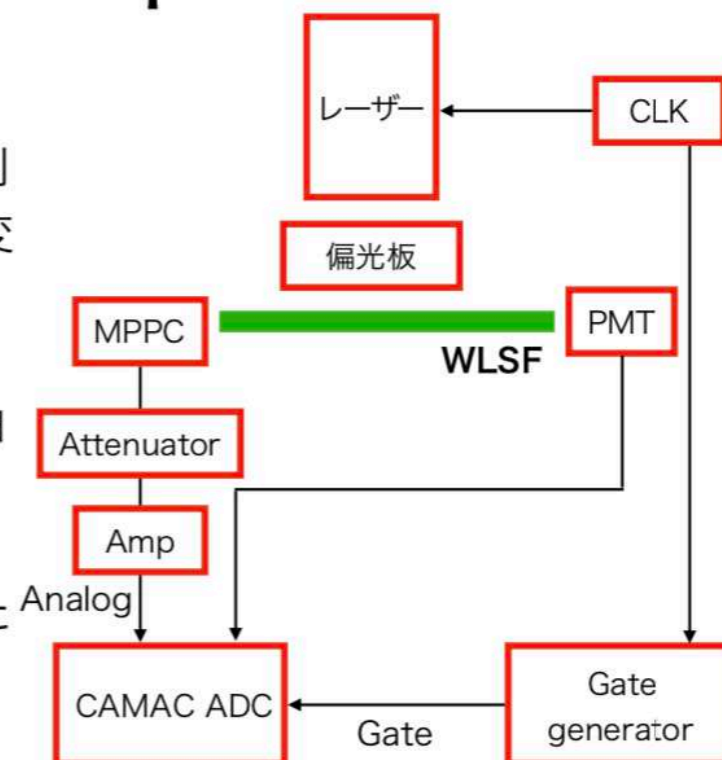

Laser

- Picosecond Diode Laserを使用
- 波長: 407nm (measured at 1MHz)
- 光らせるタイミングは内部、あるいは外部からのCLKで制御
 - 外からの入力の場合は、TTLでもNIMでもいける (TTLが基本らしいが、電圧のレベルは外から制御可能)
 - このCLKはアウトプットも可能
- 強度は0-100%まで変更可能
 - 数値が小さくなるほど強くなるらしい



Set up

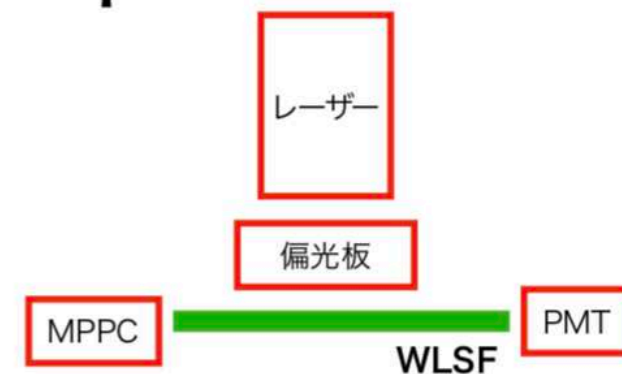
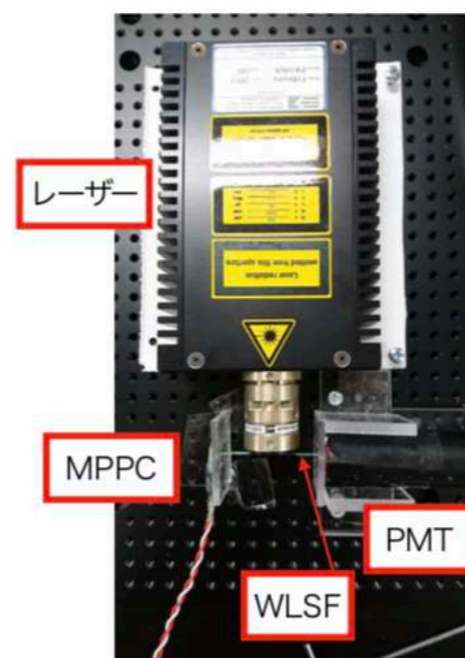

- laserからの光をWLSF経由でもPMTで見えることを確認
- 偏光板をレーザー、WLSF間に挿入
- 偏光板を回して光量を調整

結果

- 12571-015Pを用いて測定

- 以下の式で近似

$$N'_{NLO} = N_{NLO} \times \frac{\beta + 1}{\beta + \epsilon N_{in} / N_{LO}}$$

$$\begin{aligned} N_{NLO} &= N_{LO} + \alpha N_R \\ &= N_{LO} + \alpha(\epsilon N_{in} - N_{LO}) \end{aligned}$$

$$N_{LO} = N_{pix} \times (1 - e^{-\epsilon N_{in} / N_{pix}})$$

- PMTのレンジを増やす必要があるので、アッテネータの使用、或いはゲインを下げることでもっと上の領域まで測定したい
- MPPC、PMTとファイバー間の固定がまだ不十分なので、この部分の改善の必要あり

