

Sc-ECAL calibration

Naoki Tsuji, The University of Tokyo
Wataru Ootani, Jeans, Daniel
ILD Analysis/Software Meeting, 7 Oct. 2020

Sc-ECAL

- Scintillator Electromagnetic CALorimeter (Sc-ECAL)
 - Technology option of EM calorimeter for ILC and CEPC
- Based on scintillator strips readout by SiPM
 - $5 \times 45 \times 2 \text{ mm}^3$ scintillator strip
- Virtual segmentation : $5 \times 5 \text{ mm}^2$ with strips in x-y configuration
 - # readout channels significantly reduced ($10^8 \rightarrow 10^7$)
→Low cost
 - Retaining performance comparable to real $5 \times 5 \text{ mm}^2$ segmentation
- Timing resolution < 1 ns

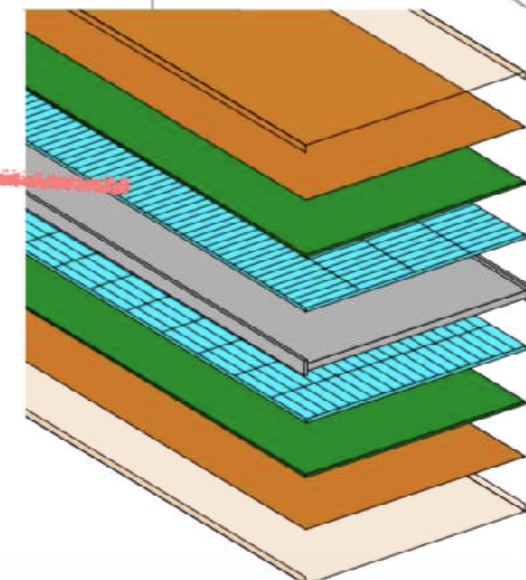
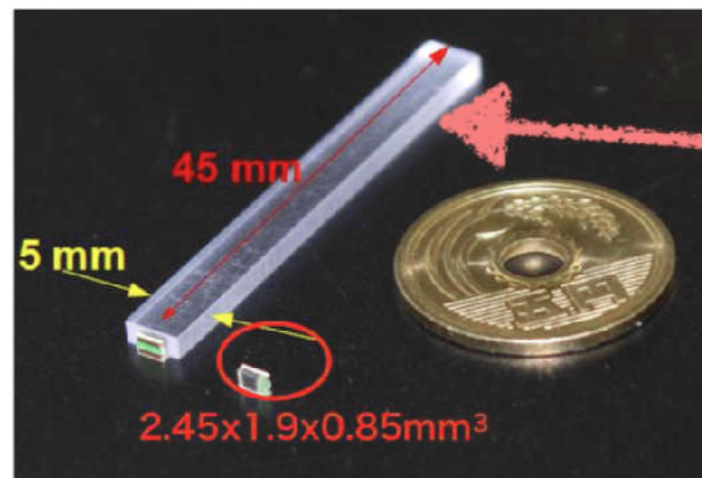
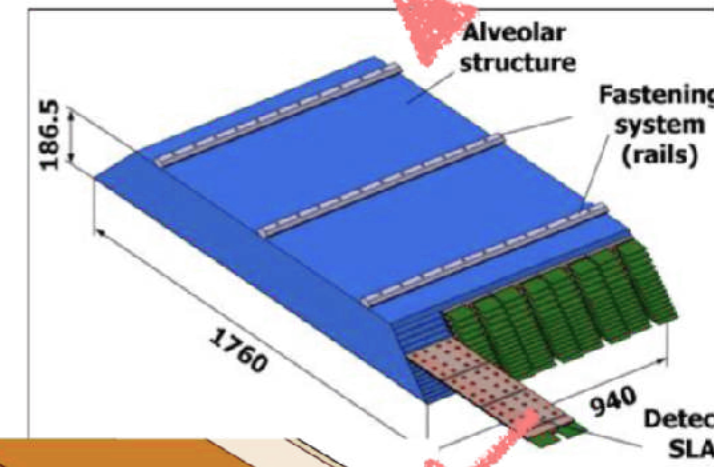
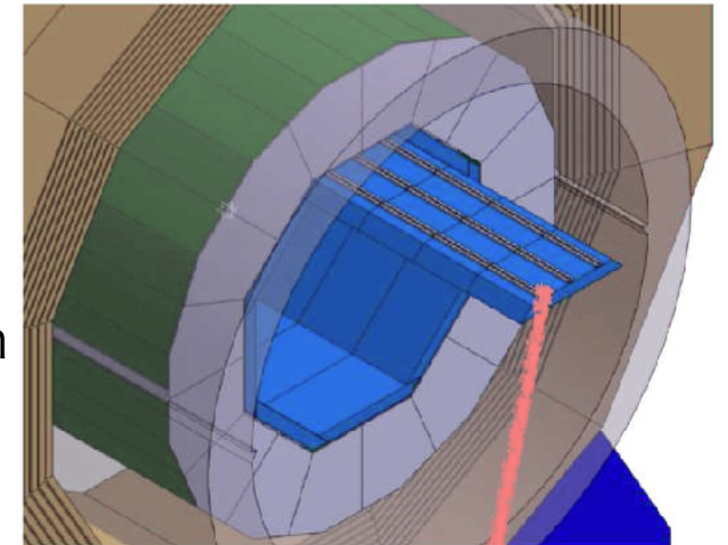

Previous study

- R. Terada done ILD simulation for Sc-ECAL
 - ILD version is old one: v01-19
 - Calibration parameter is different from the latest result
 - 7 MipPe is small
- The objective of this talk is to calibrate the parameters for Sc-ECAL using the latest ILD model
 - Final goal of this study is to evaluate the Sc-ECAL performance with the latest ILD version

Sensor type	ScECAL	SiECAL
Collection	ECal*ScHits	ECal*SiHits
CaloDigi	RealisticCaloDigiScinPpd	RealisticCaloDigiSilicon
ppd_mipPe (p.e)	7	-
ppd_npix (pixel)	10,000	
calibration_mip (GeV)	0.0002407 (at Barrel) 0.0002472 (at Endcaps)	0.0001575
calibration_factorsMipGev	0.006729 (at Barrel) 0.007256 (at Endcaps)	0.00641222630095

Calibration Data



Scintillator (45 x 5 x 2 mm²)

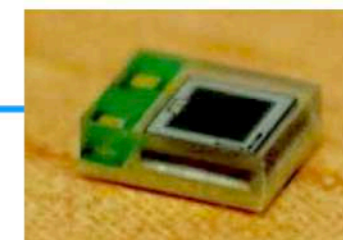

MPPC (10k pixel)

Device parameters

Simulation Parameter

- DD4hep
 - Both Sc and Si sensor
 - Compare two models with same events
- ILD version: v02-01
- Detector model: ILD_I5_03_v02
- Use default Pandora PFA parameters
- Calibration parameters decided as below at new ILD model

ppd_mipPe (p.e.)	10	
ppd_npix (pixel)	10000	
EcalBarrel/EndcapMip	0.0002629	
	0.0002655	
EcalBarrel/	0.00758	0.01515
EndcapEnergyFactors	0.00810	0.01619
PandoraEcalToEMScale	1.031	

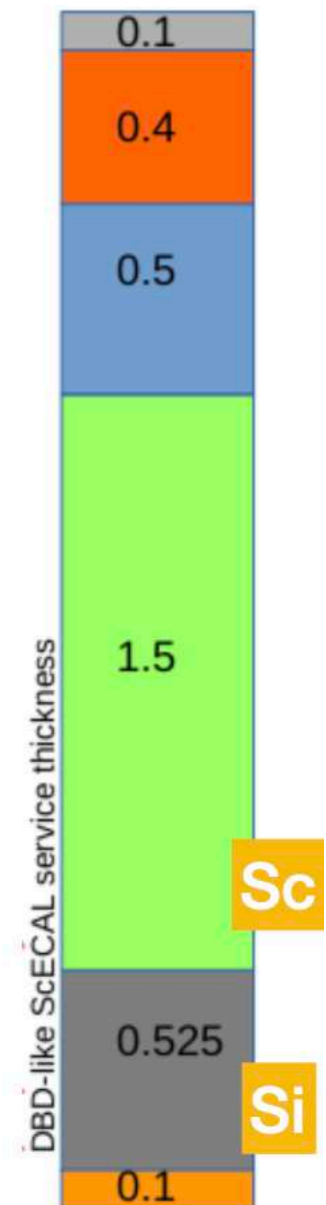

DD4hep

MIP calibration

- EcalBarrel/EndcapMip calibration done
 - Data: 10 GeV muon
 - Collection: EcalBarrel/EndcapCollection
 - Fit: langaus function
- The peak of hit energy is the value of MipPe.
- Independent calibration with barrel and endcap

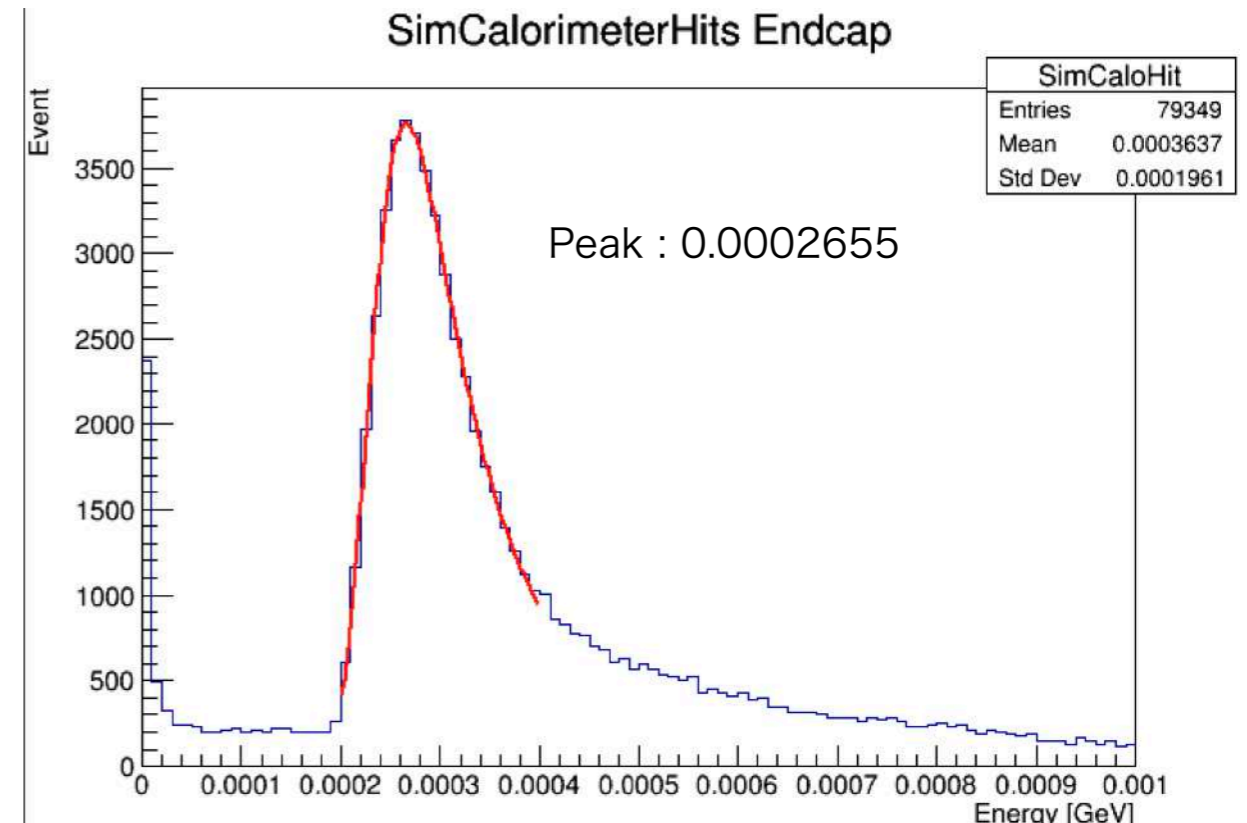
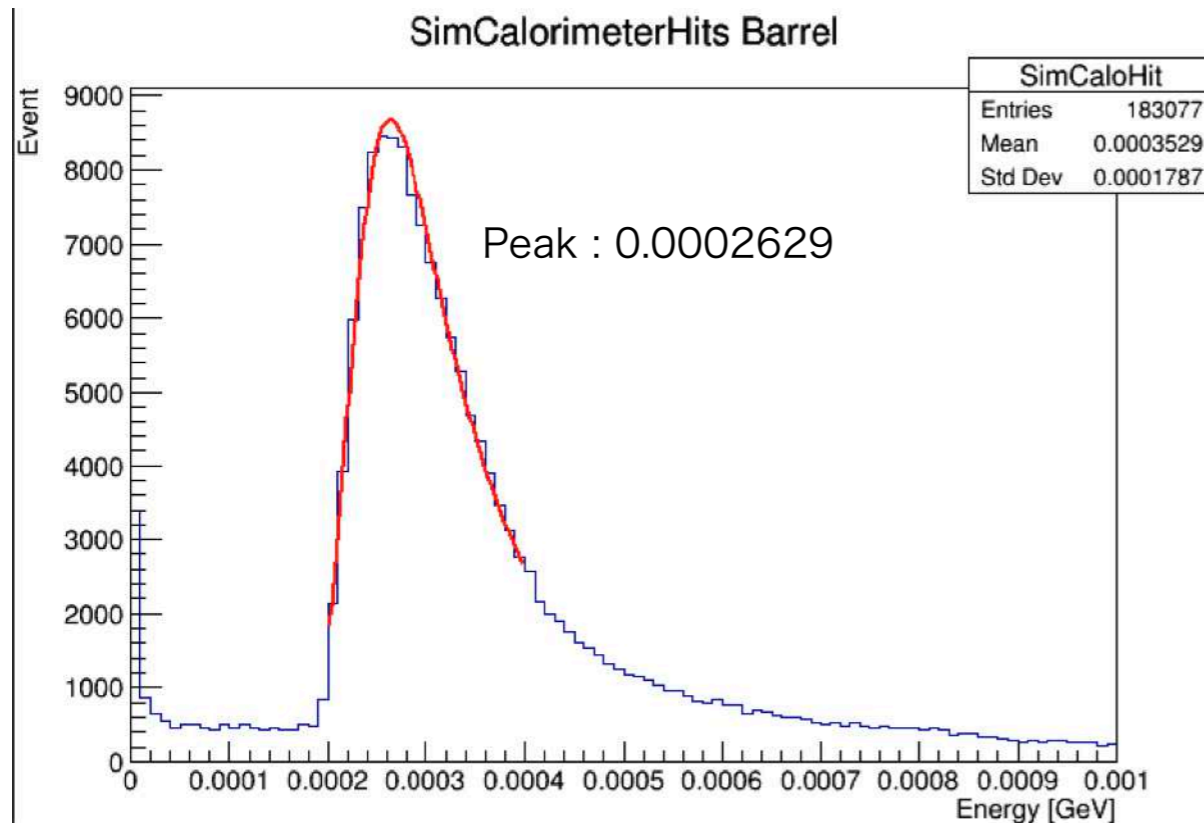

Energy Factors calibration

- Energy factors calibration done
 - Data: 10 GeV gamma
 - Collection: MCParticle, EcalBarrel/EndcapCollectionRec
 - Fit: gaussian
 - Range: $\pm 1.5 \times \text{sigma}$
- Multiply the factors by 10/peak

CosTheta vs. EnergySum

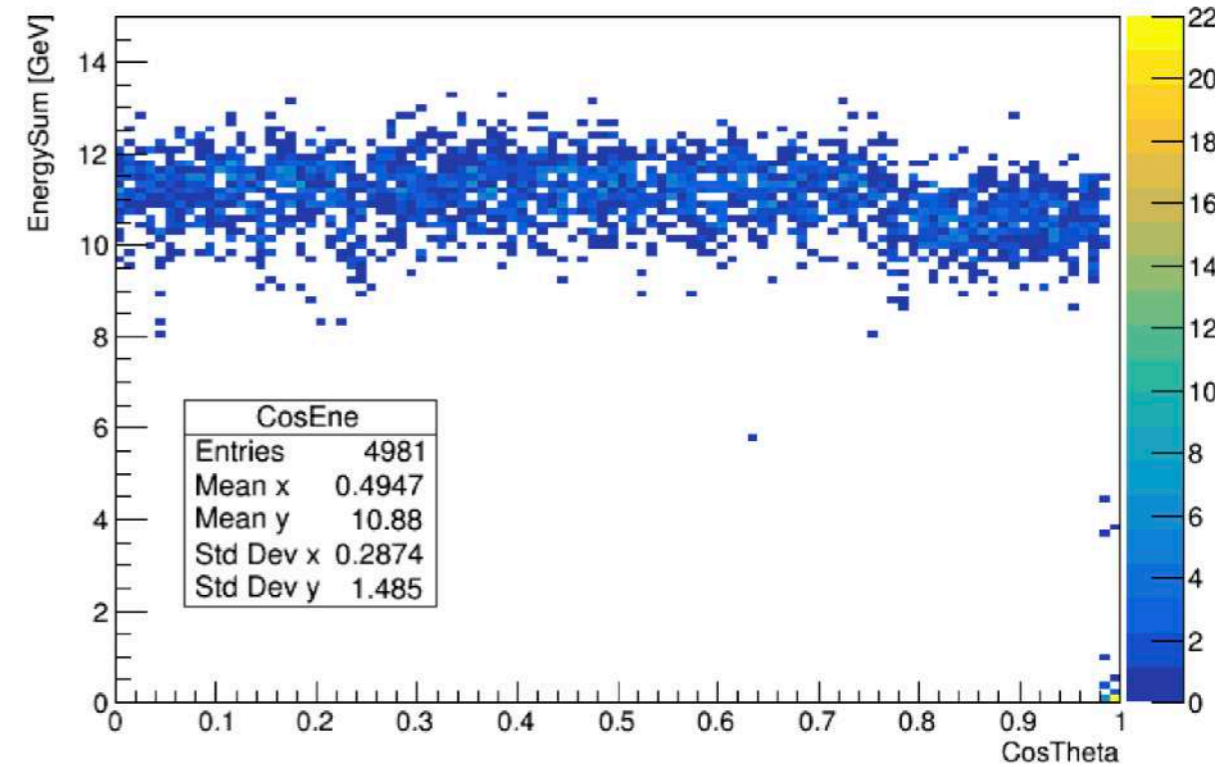

Sum of hit energies Barrel ($0 \leq \text{cos} \leq 0.7$)

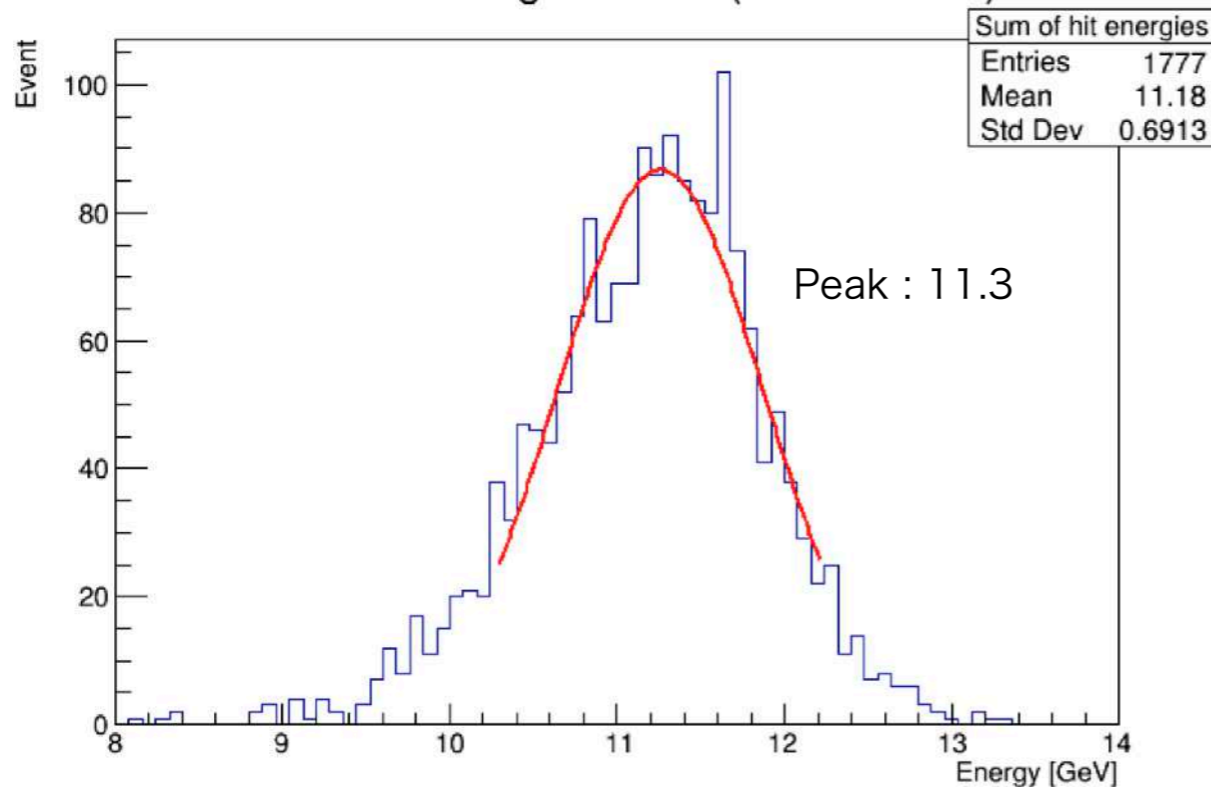

Sum of hit energies ENdcap ($0.75 \leq \text{cos} \leq 0.95$)

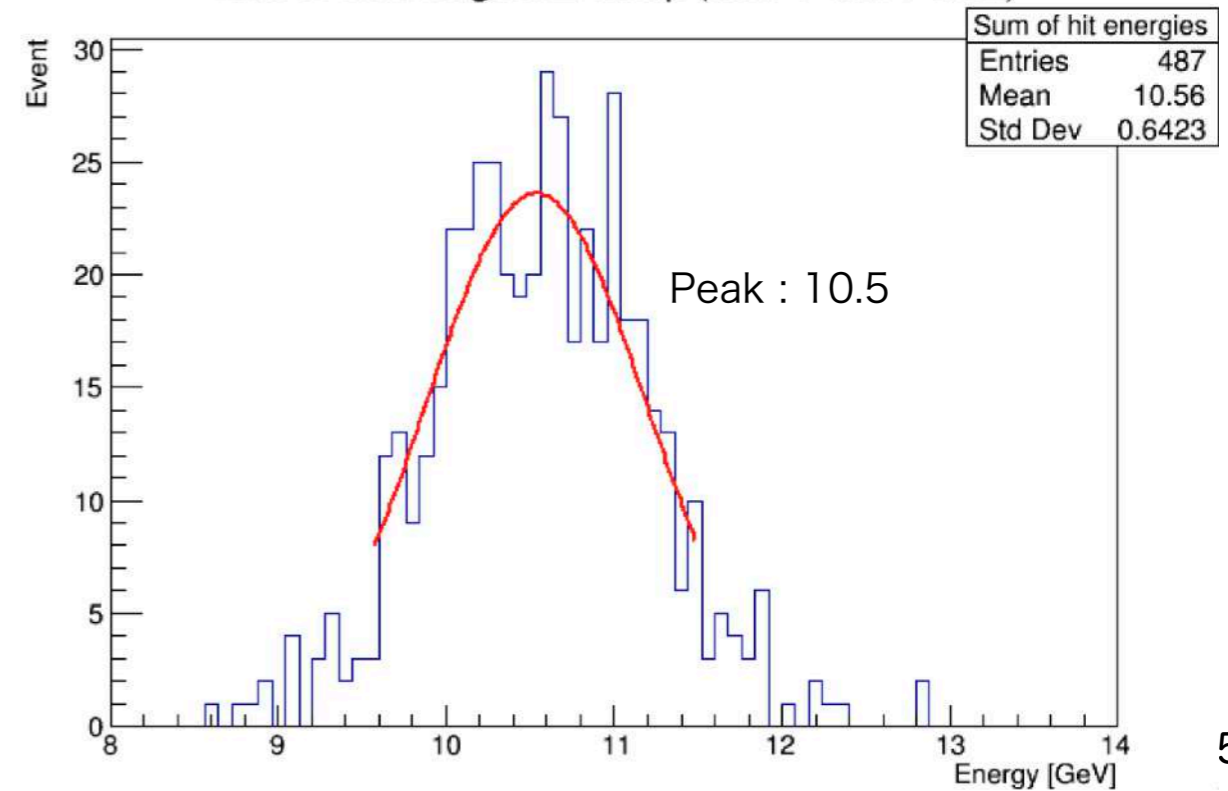

Energy Factors calibration

- Sum of hit energies are located 10 GeV accurately
 - Both at barrel and endcap

CosTheta vs. EnergySum

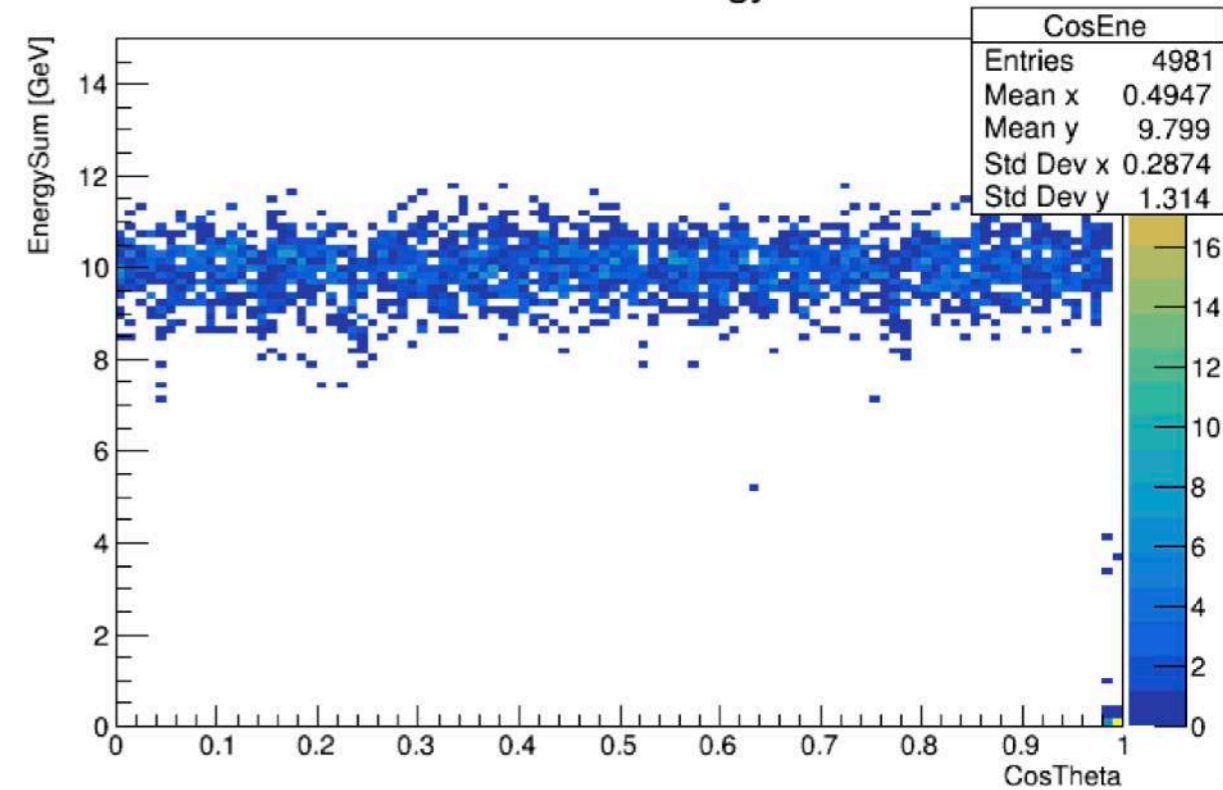

Sum of hit energies Barrel ($0 \leq \cos \leq 0.7$)

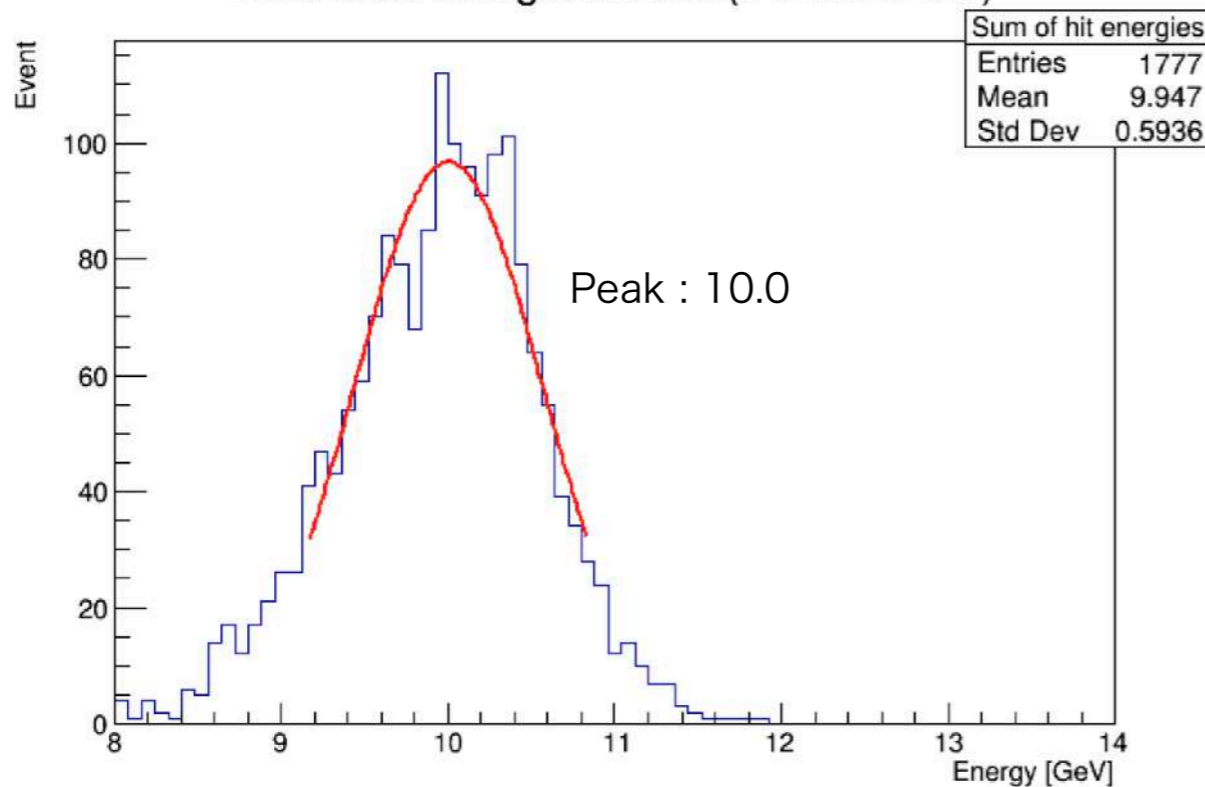

Sum of hit energies ENdcap ($0.75 \leq \cos \leq 0.95$)

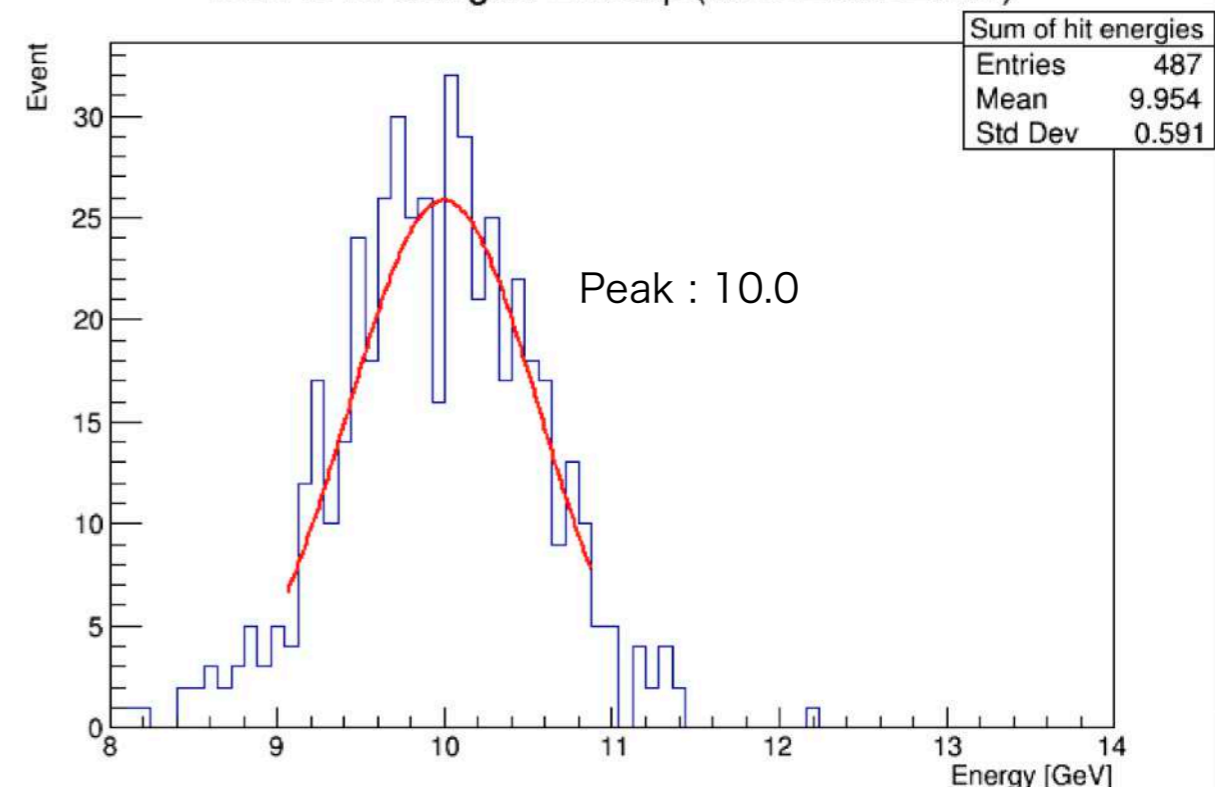

EM scale calibration

- PandoraEcalToEMScale calibration done
 - Data: 10 GeV gamma
 - Collection: MCParticle, PandoraPFOs
 - Fit: gaussian
 - Range: $\pm 1.5 \times \text{sigma}$
- Multiply the factors by 10/peak

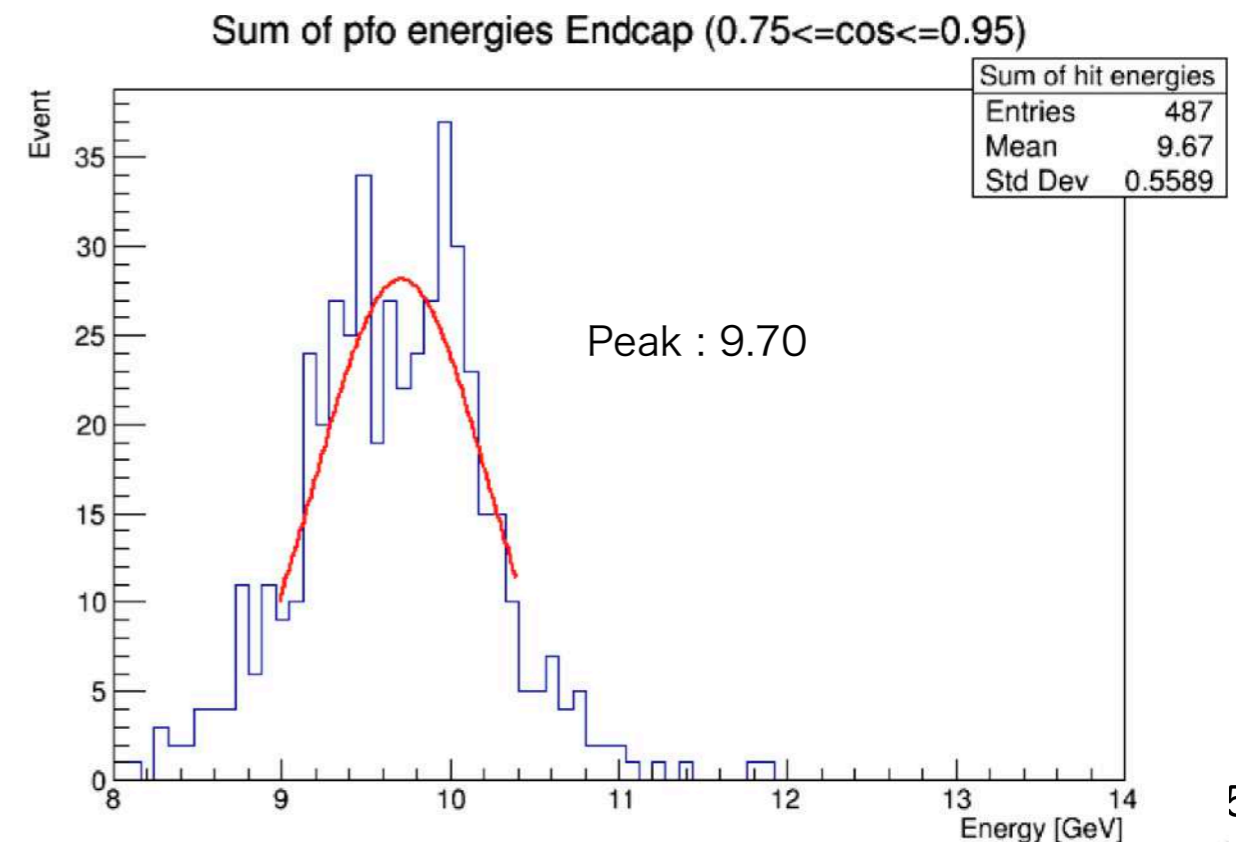
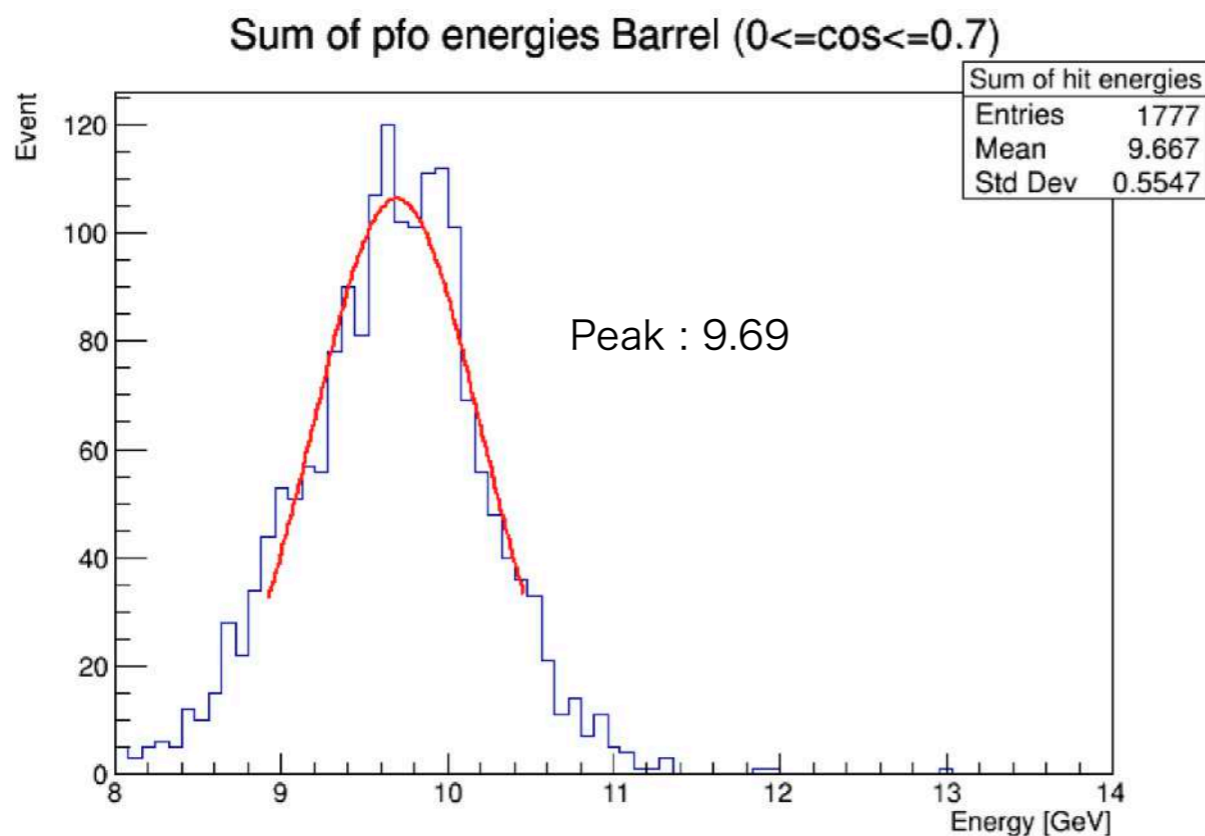

EM scale calibration

- Sum of PFO energies are located 10 GeV
 - Both at barrel and endcap
- Calibration completed

ppd_mipPe (p.e.) 10

ppd_npix (pixel) 10000

EcalBarrel/EndcapMip 0.0002629
0.0002655

EcalBarrel/
EndcapEnergyFactors 0.00758 0.01515
0.00810 0.01619

PandoraEcalToEMScale 1.031

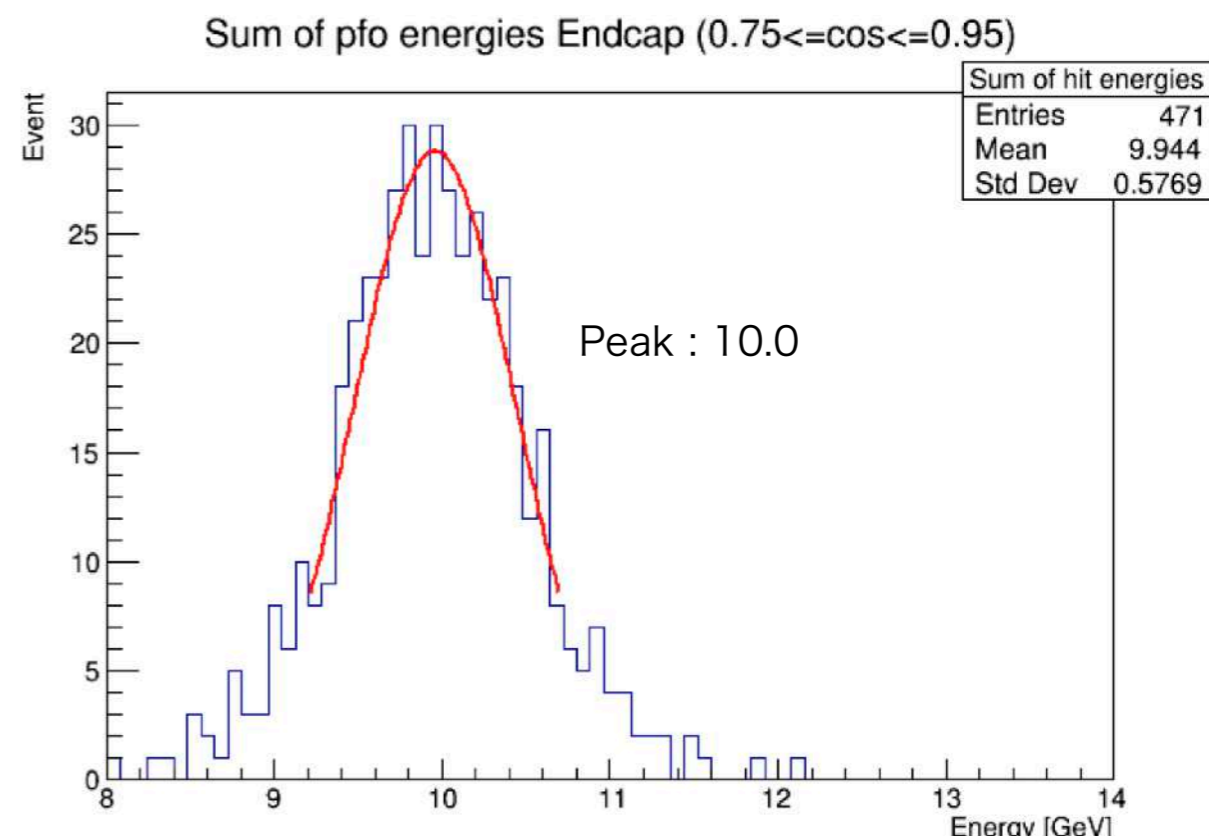
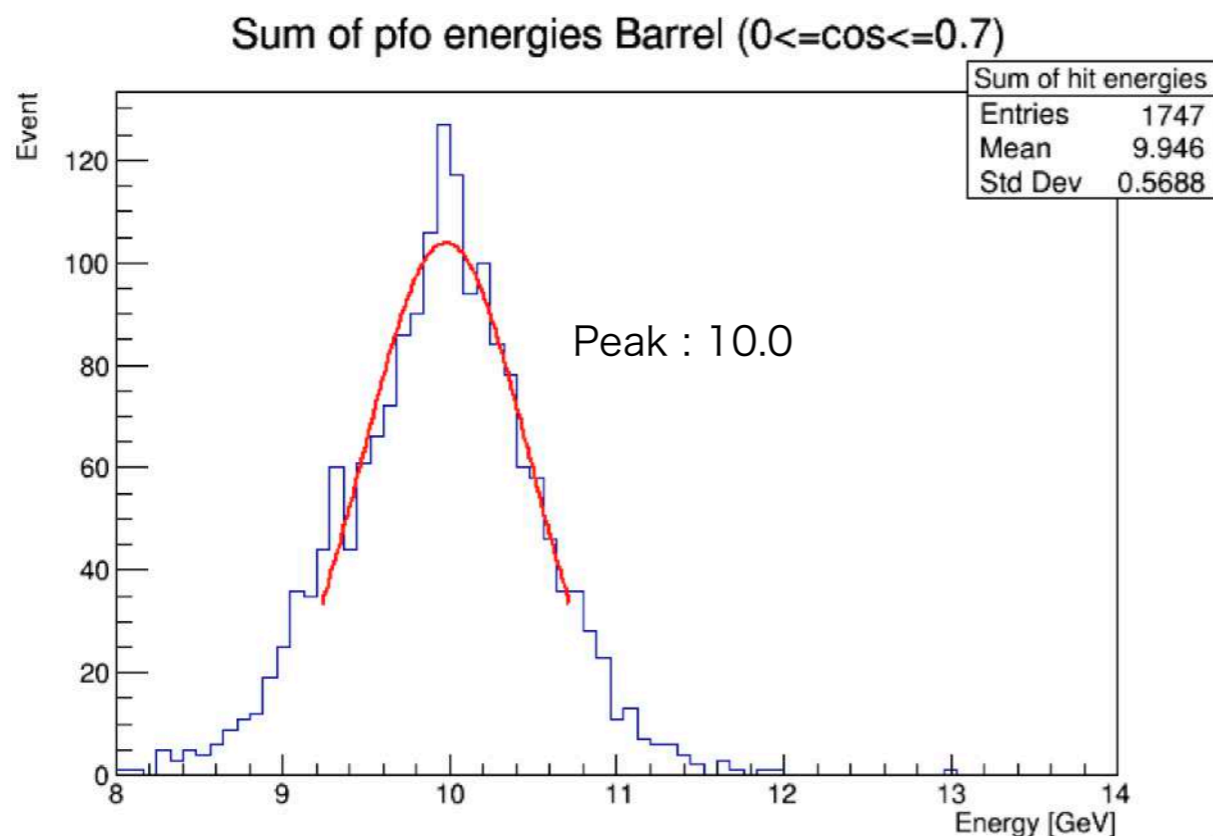

Energy linearity

- Injection gamma at different energies
 - 5, 10, 20, 30, 40, 50, 100, 200 GeV
 - Check the peak of PFO energy
- Energy linearity is good
 - A bit shift to large at the large energy injection
 - Gap filter for Si-ECAL is implemented, but not working properly

Mean of sum of PFO energies

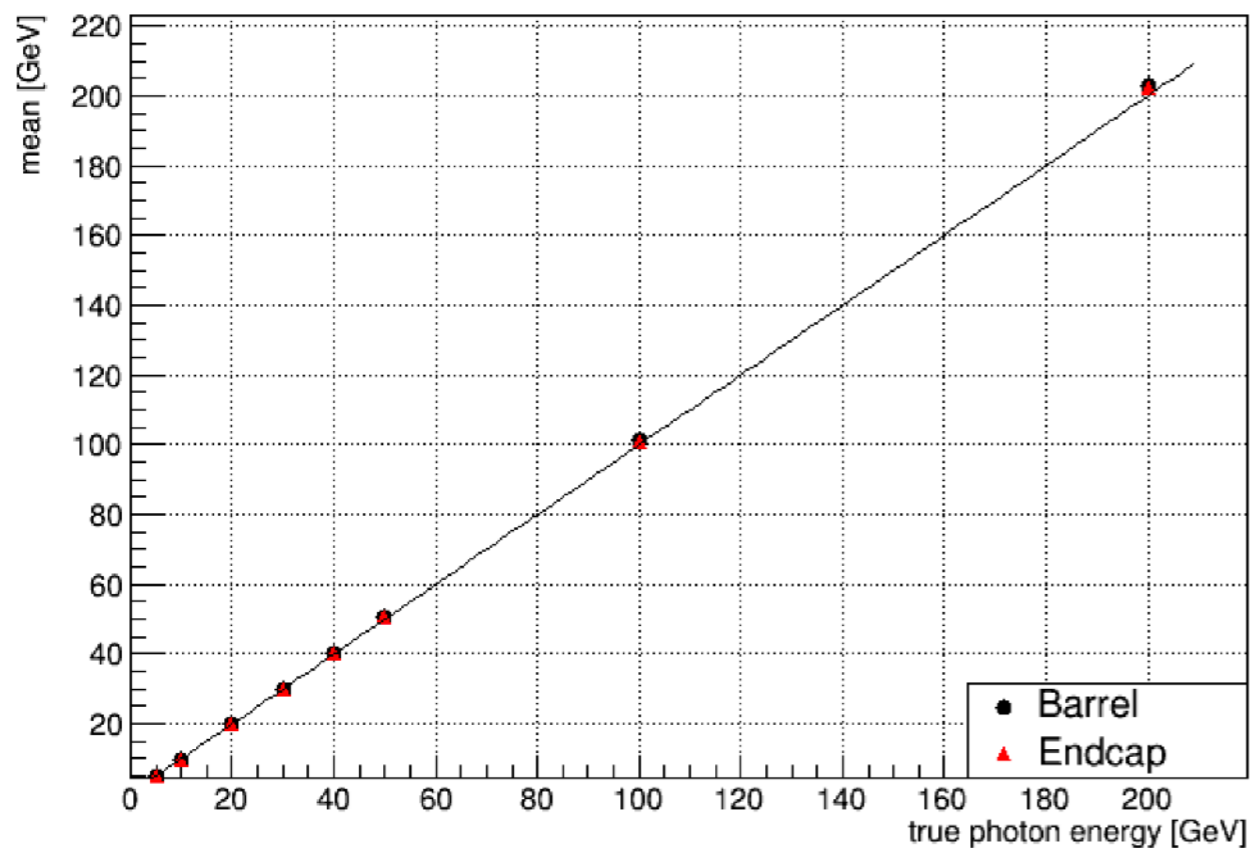

(mean - true) / true

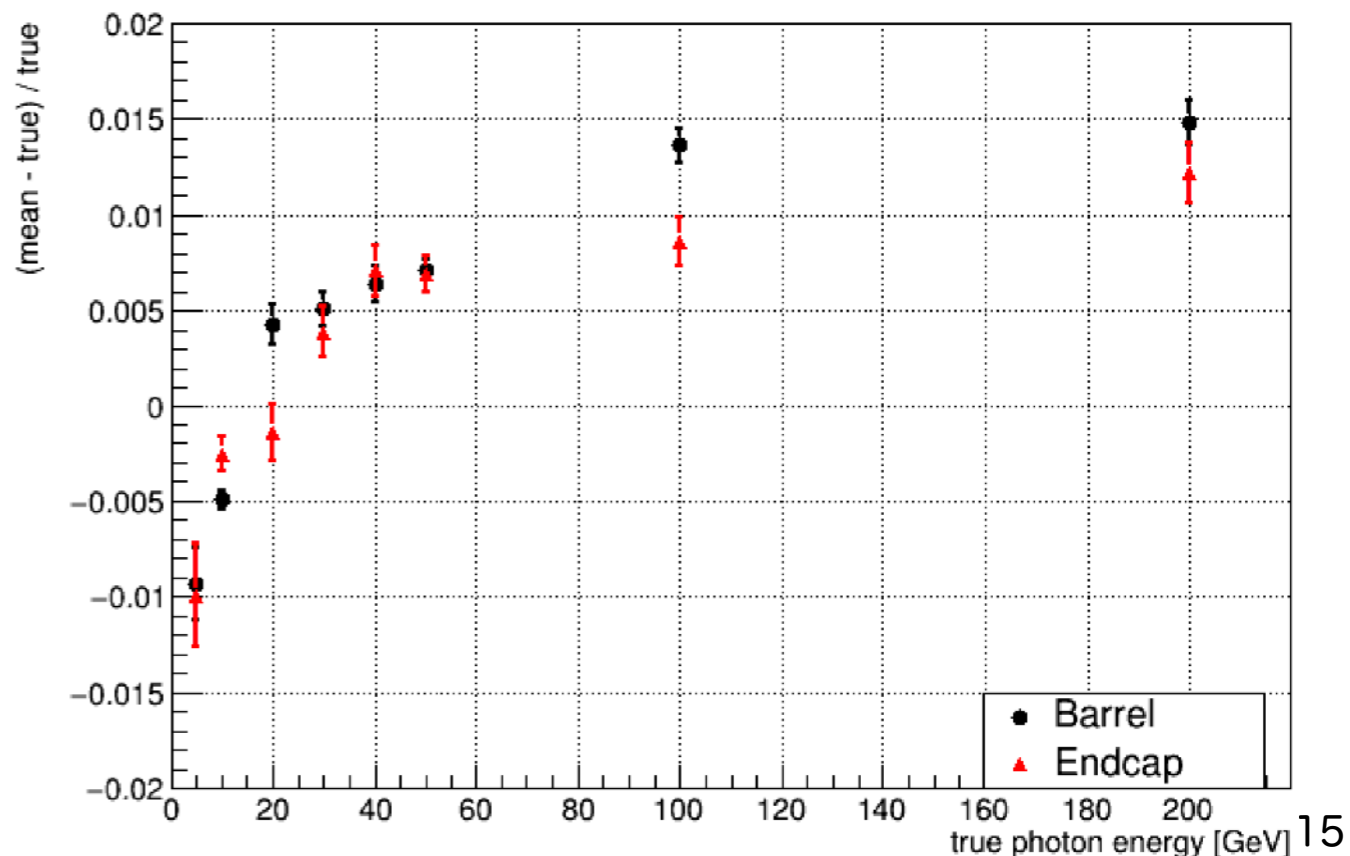

Energy resolution

- Energy resolution is calculated using PFO
 - Fit : $\left(\frac{\sigma_E}{E}\right)^2 = \left(\frac{a}{\sqrt{E}}\right)^2 + (b)^2$
- 16% resolution achieved
 - Reasonable result for Sc-ECAL
 - Comparison with Si-ECAL will be done

	Barrel	Endcap
Stochastic a	16.1	16.5
Constant b	1.97	1.99

energy resolution vs. true photon energy

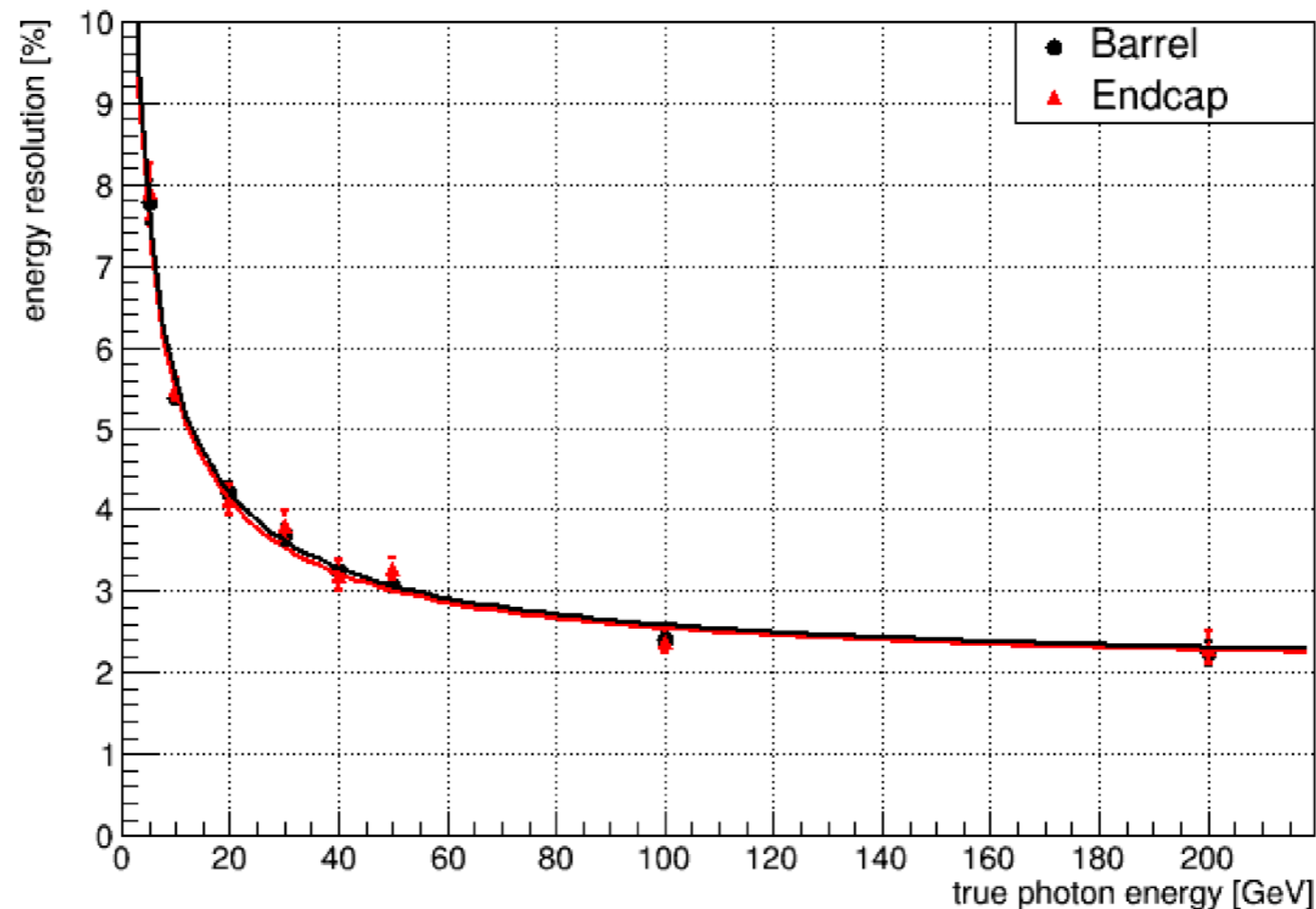

New sample with v02-01-02

- New test production sample with ILCSoft v02-01-02
 - Created by H. Ono, A. Miyamoto
- Detector model
 - ILD_I5_o1_v02 (AHCAL + Si-ECAL)
 - ILD_I5_o3_v02 (AHCAL + Sc-ECAL)
- Contents at ILD_I5_o3_v02:
 - Single muon and single photons
 - 2f-JER (di-samples)
 - Calibrated parameters implemented
- Check the performance of single photon event
 - Energy linearity
 - Energy resolution

Energy linearity with new sample

- The linearity is a bit worse compared to previous sample
 - Gap filter not implemented
 - Now preparing gap filter for Sc-ECAL

Mean of sum of PFO energies

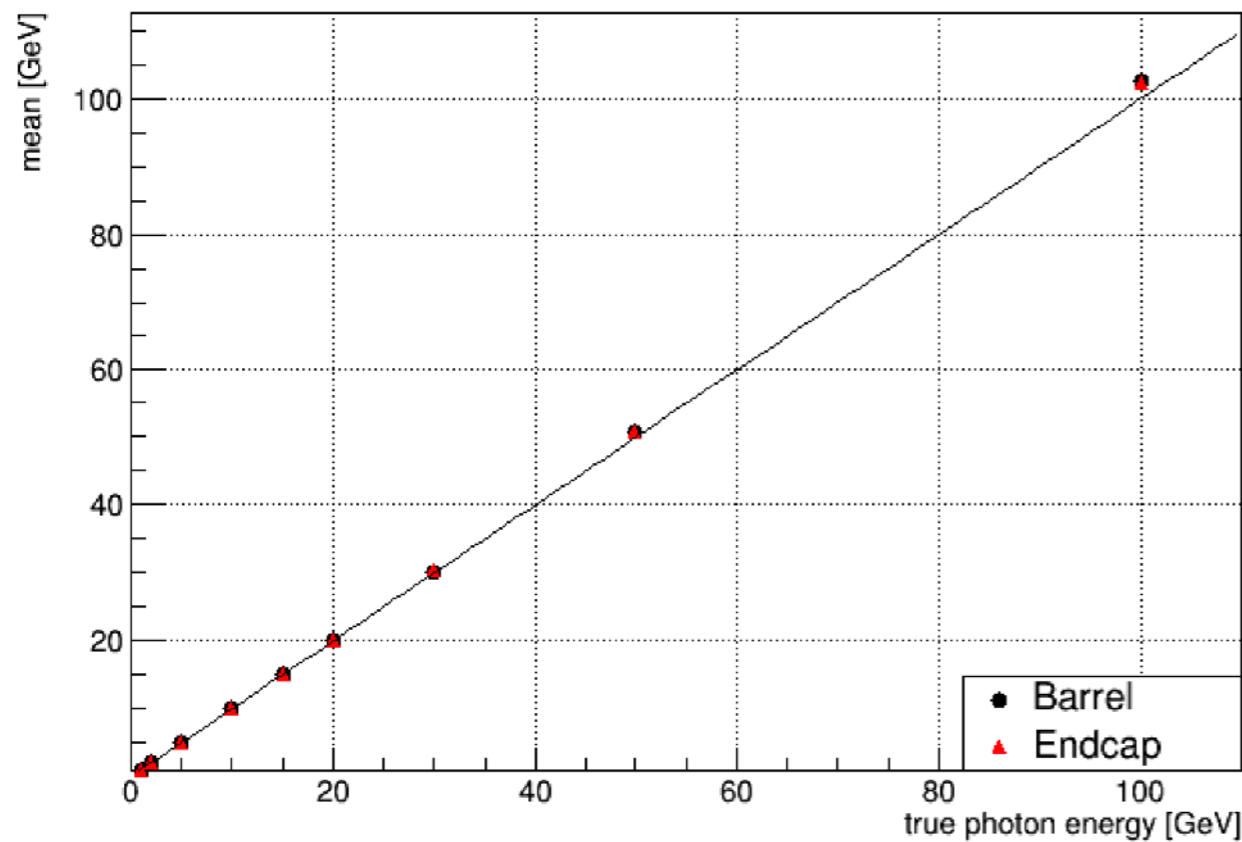

(mean - true) / true

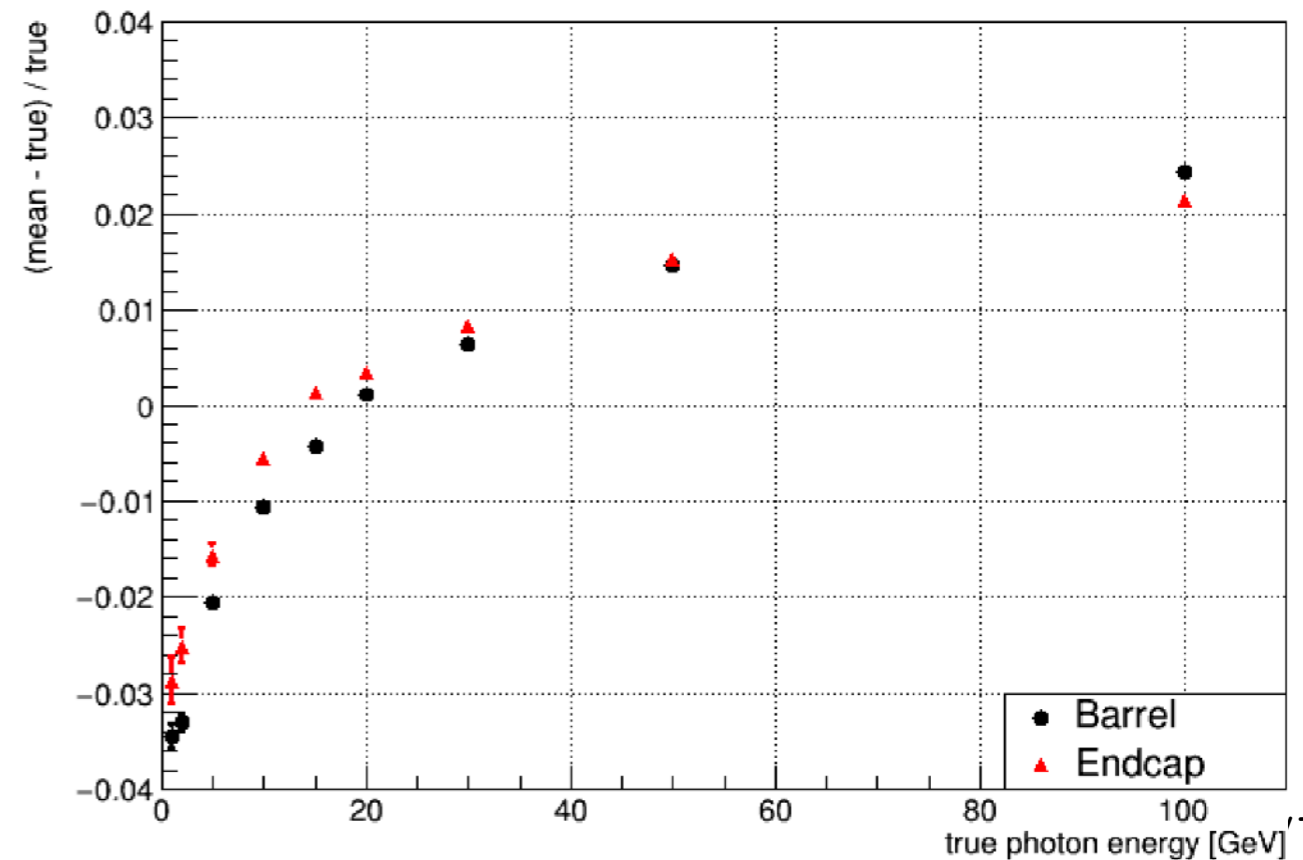

Energy resolution with new sample

- 16% resolution with 2% constant
 - Almost the same as the previous sample

	Barrel	Endcap
Stochastic a	16.3	15.8
Constant b	2.05	2.16

energy resolution vs. true photon energy

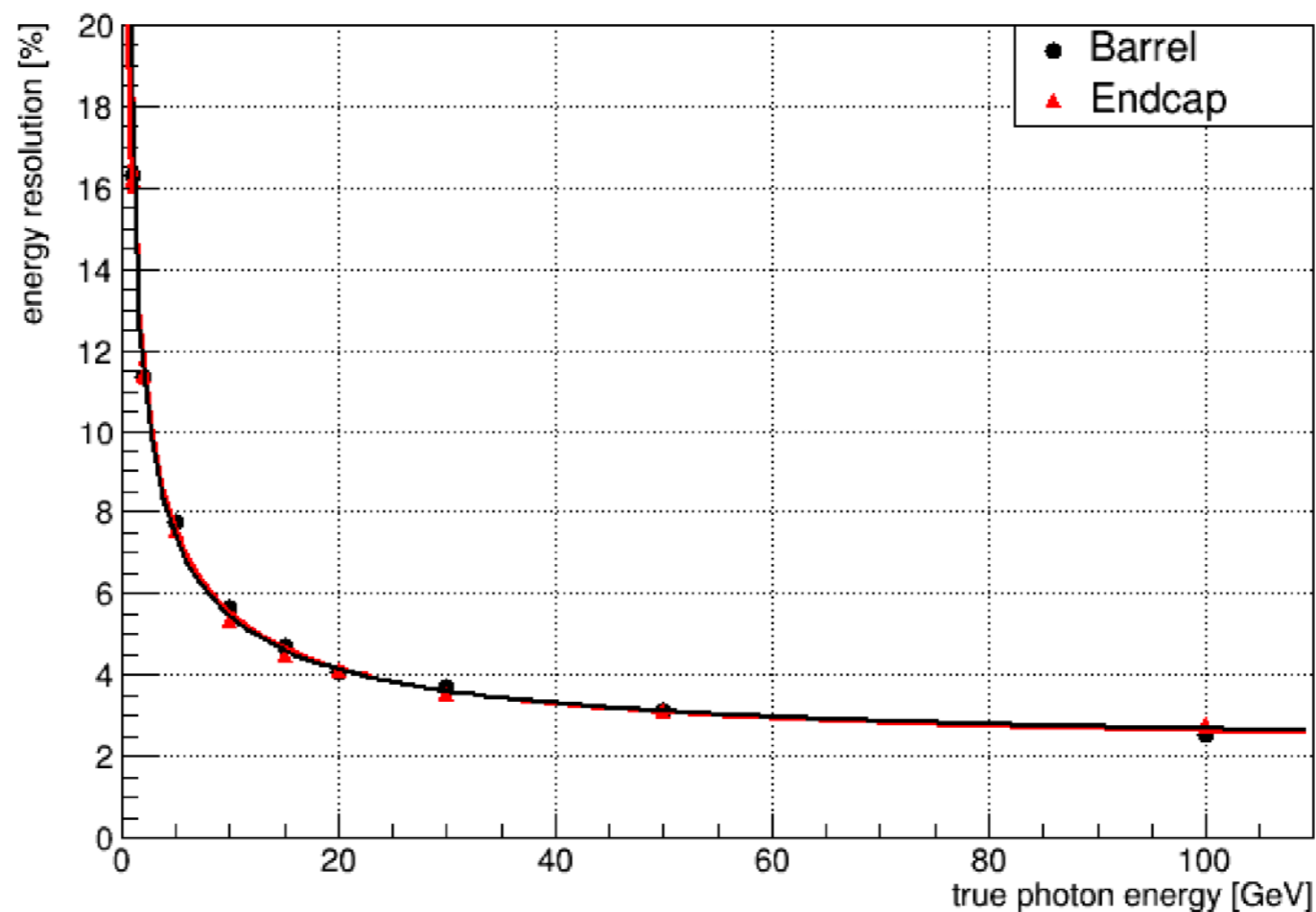

Summary and prospects

- ILD simulation for Sc-ECAL
 - Parameter calibration for Sc-ECAL with new detector model
- Calibration completed
 - MIP, energy factors, EM scale
 - Energy linearity is good
 - Energy resolution is reasonable
- Compare the result with LCCalibration
- Preparing the gap filter for Sc-ECAL
 - Set different parameters according to x-y strip orientation
- Evaluate the saturation effect
 - Apply real saturation curve measured by UV laser
 - Preparing new setup for more accurate measurement
- Evaluate the performance of jet sample

Backup

Cos vs. Hit Energy Sum

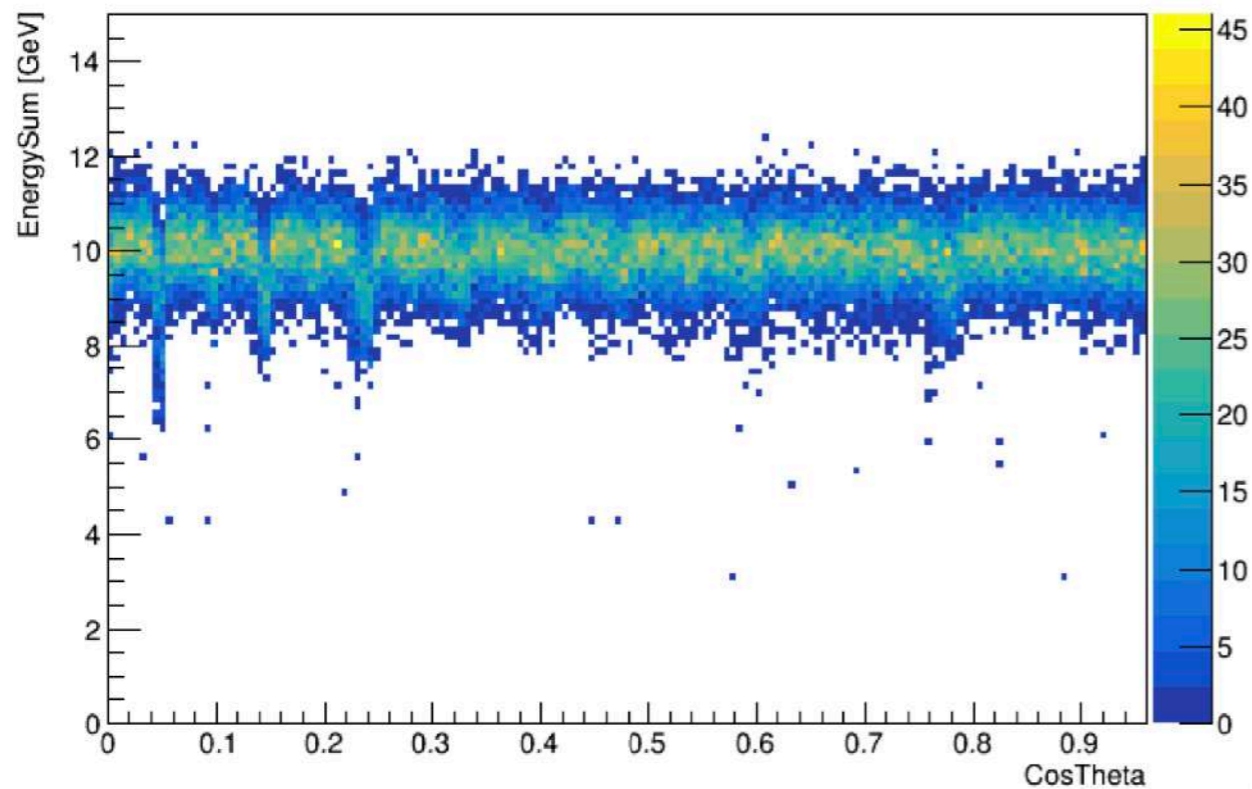

Cos vs. Pfo Energy Sum

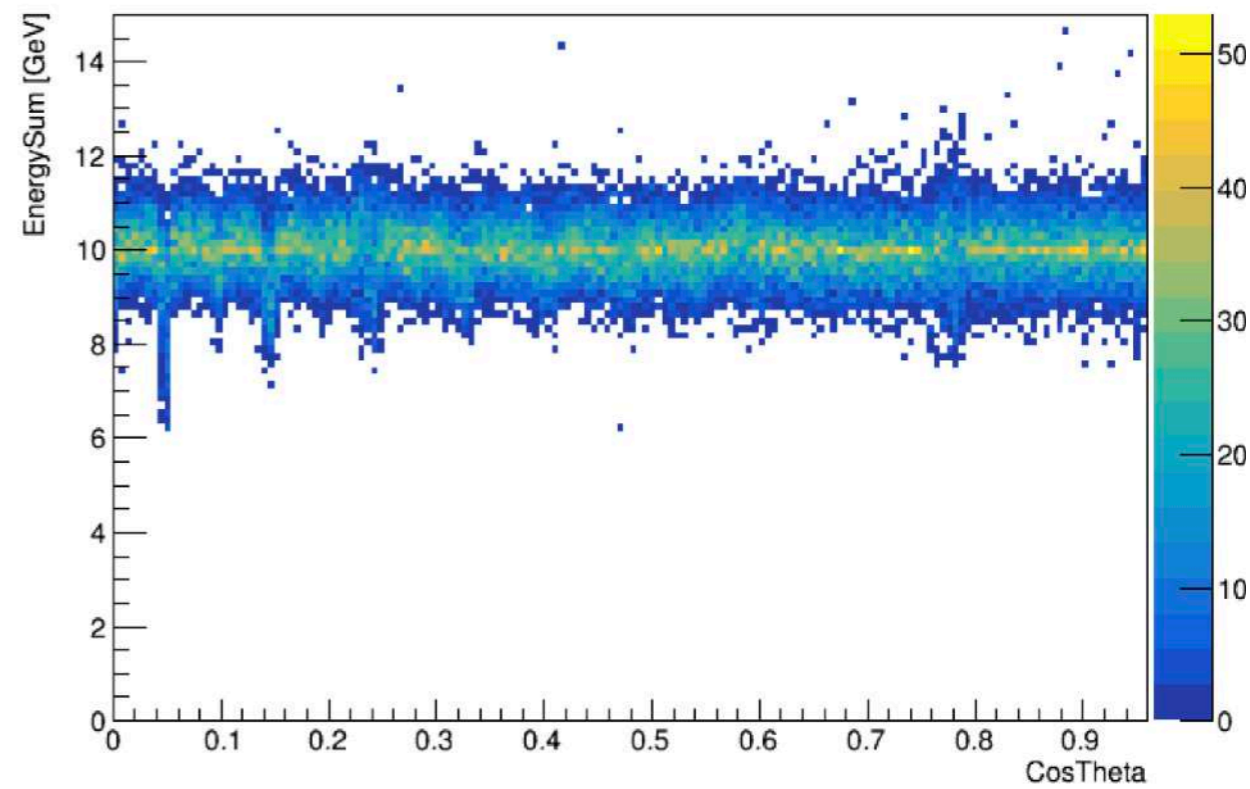

Cos vs. Hit Energy Sum

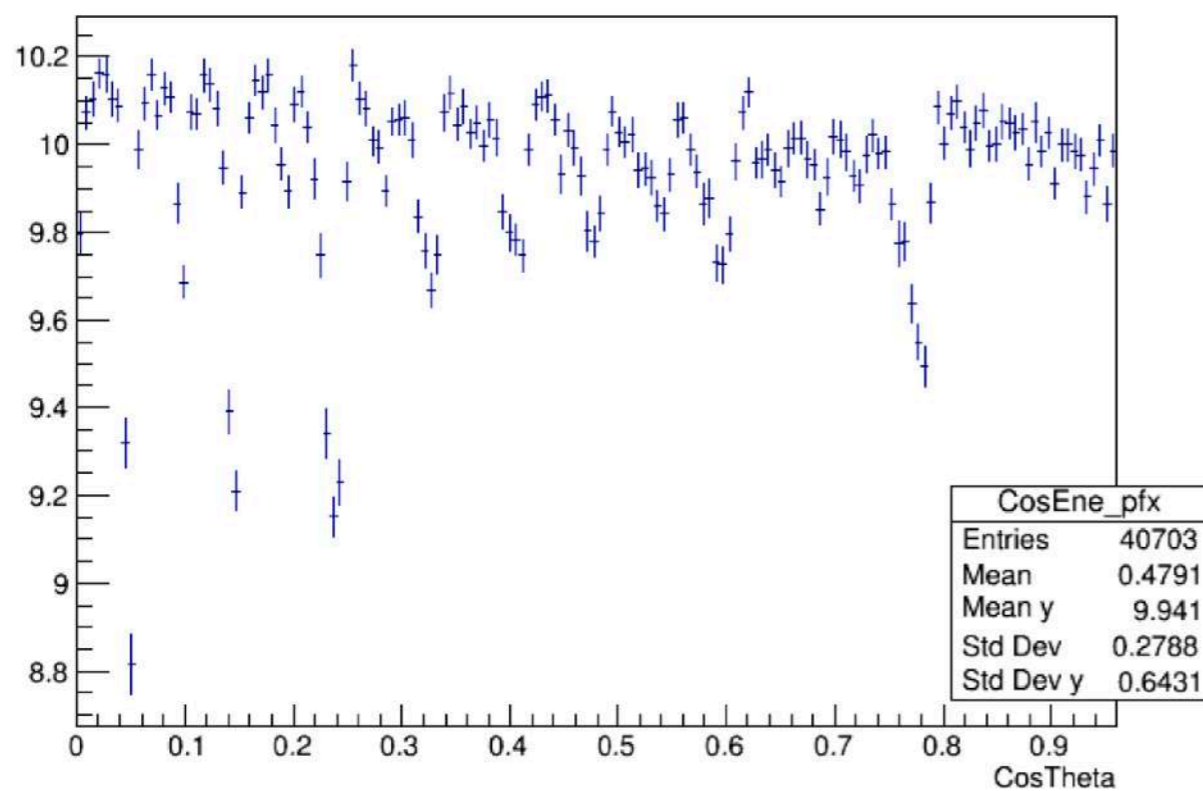

Cos vs. Pfo Energy Sum

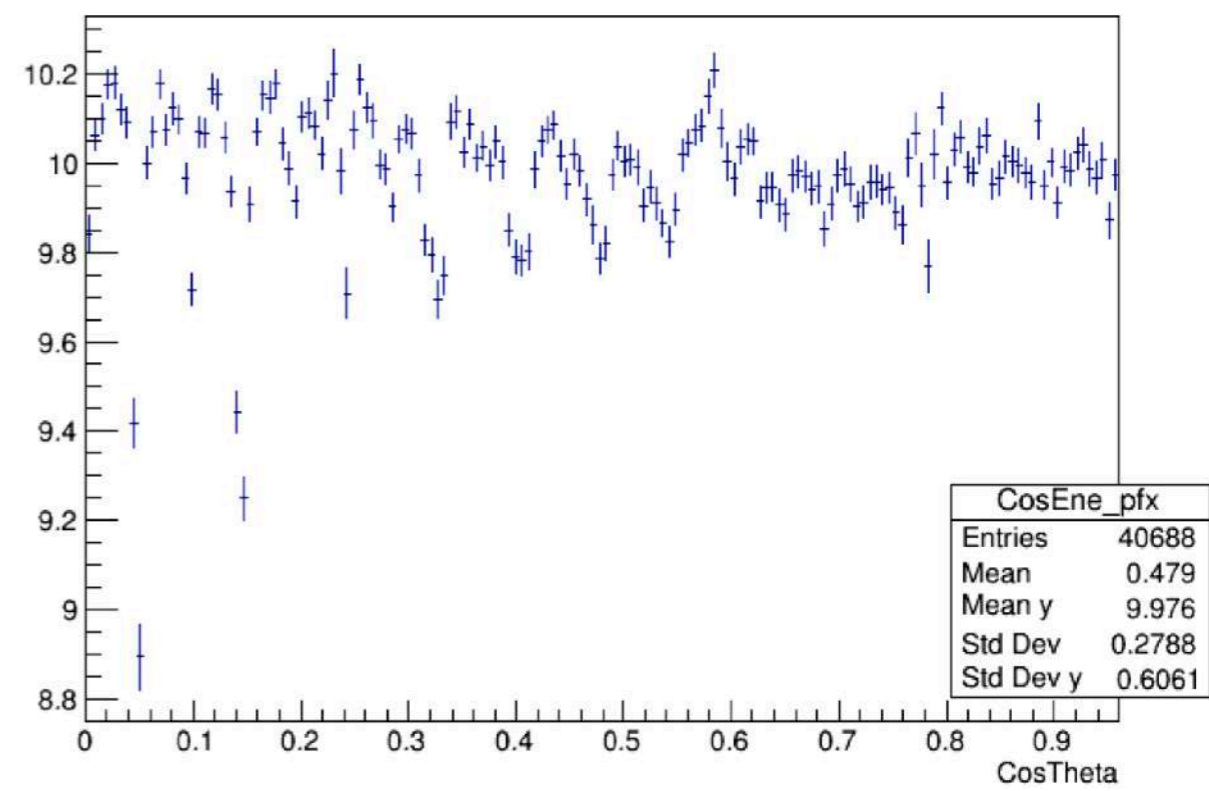

Phi vs. Hit Energy Sum

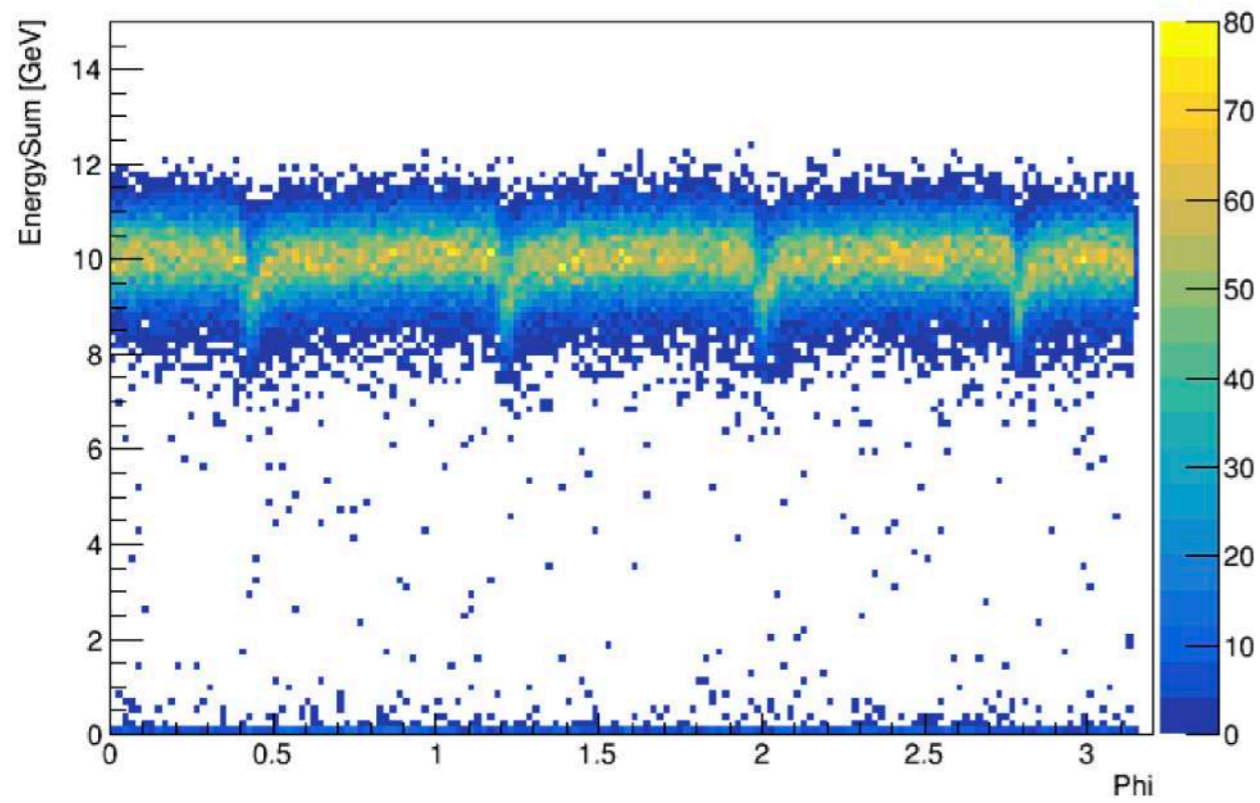

Phi vs. PFO Energy Sum

