



TPC Development by the LCTPC Collaboration for the ILD Detector at ILC

Jochen Kaminski
for LCTPC

TIPP
Triumpf, CA
24.-28.05.2021

International Linear Collider



International Linear Collider (ILC) /
Chinese Electron Position Collider (CEPC)

are both e^+e^- colliders with:

$\sqrt{s} = 90 \text{ GeV} - 1 \text{ TeV} / 90\text{-}240 \text{ GeV}$

Overall length of $21\text{-}50 \text{ km} / 100 \text{ km}$

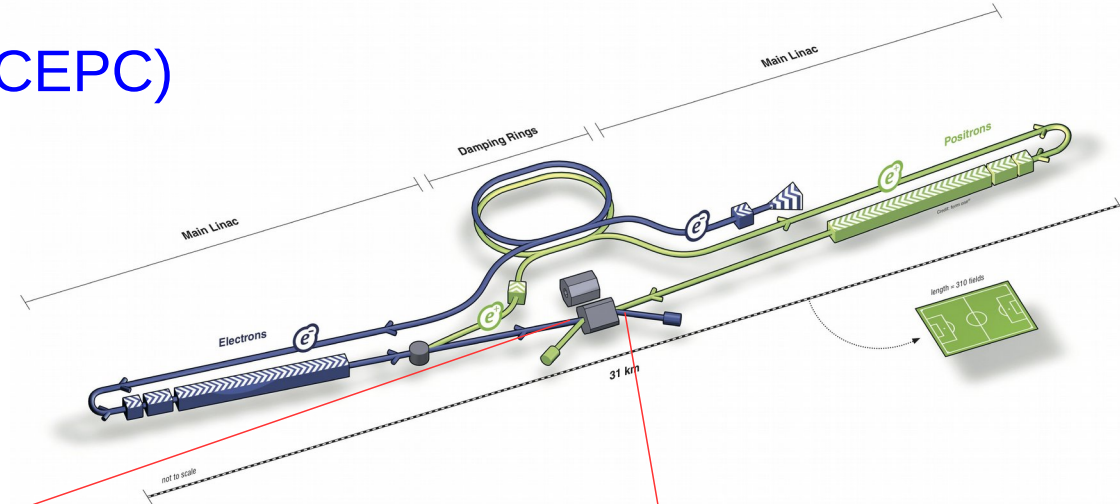

Bunch structure (example ILC):

Charging the superconducting cavities takes 0.1-0.2 s, then particles can be accelerated for about 1 ms.

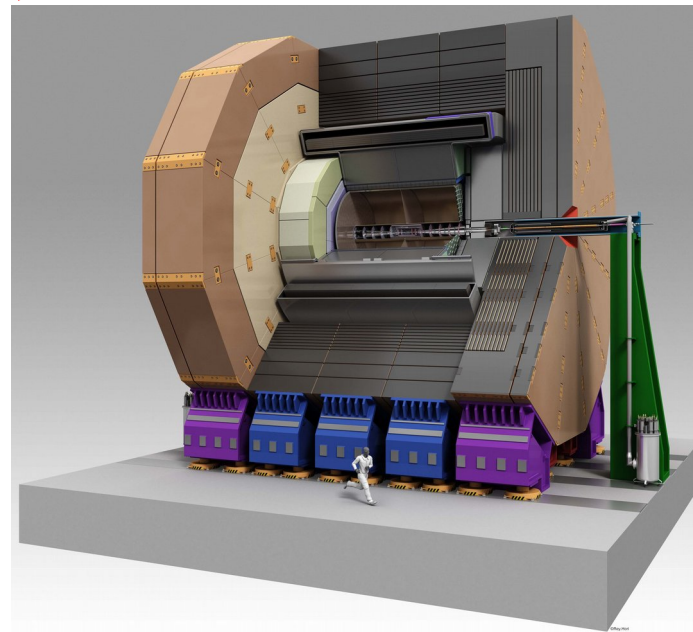
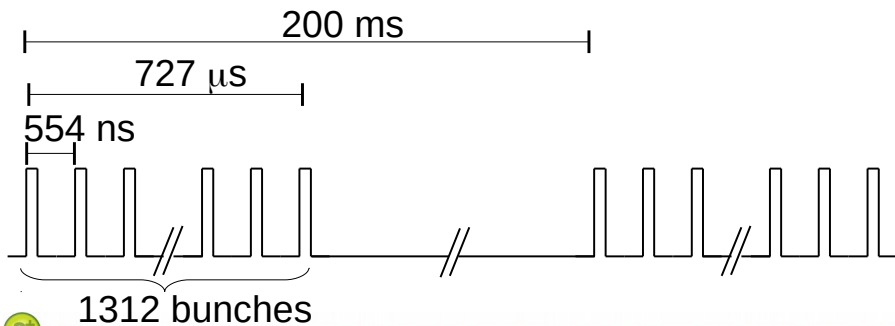

International Large Detector

- Standard layout HEP detector with improved performance
- TPC as main tracker
- Interchanged with SiD by push and pull principle

ILD-TPC Requirements



Requirements are driven by benchmark processes, in the case of ILD – TPC the most stringent measurement is the **Higgs-recoil measurement**:

Requirements of TPC from ILC TDR vol. 4

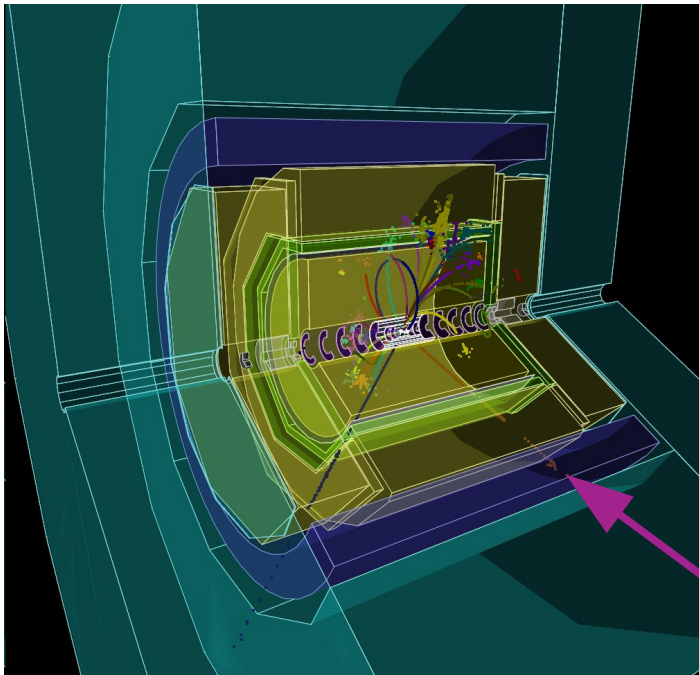

Parameter	r_{in}	r_{out}	z
Geometrical parameters	329 mm	1808 mm	± 2350 mm
Solid angle coverage	up to $\cos\theta \simeq 0.98$ (10 pad rows)		
TPC material budget	$\simeq 0.05 X_0$ including outer fieldcage in r $< 0.25 X_0$ for readout endcaps in z		
Number of pads/timebuckets	$\simeq 1-2 \times 10^6/1000$ per endcap		
Pad pitch/ no.padrows	$\simeq 1 \times 6 \text{ mm}^2$ for 220 padrows		
σ_{point} in $r\phi$	$\simeq 60 \mu\text{m}$ for zero drift, $< 100 \mu\text{m}$ overall		
σ_{point} in rz	$\simeq 0.4 - 1.4$ mm (for zero – full drift)		
2-hit resolution in $r\phi$	$\simeq 2$ mm		
2-hit resolution in rz	$\simeq 6$ mm		
dE/dx resolution	$\simeq 5\%$		
Momentum resolution at B=3.5 T	$\delta(1/p_t) \simeq 10^{-4}/\text{GeV}/c$ (TPC only)		

In addition: very high efficiency for particle of more than 1 GeV.

These requirements can not be fulfilled by conventional wire-based read out. **New Micropattern-based readouts have to be applied.**

LCTPC Collaboration

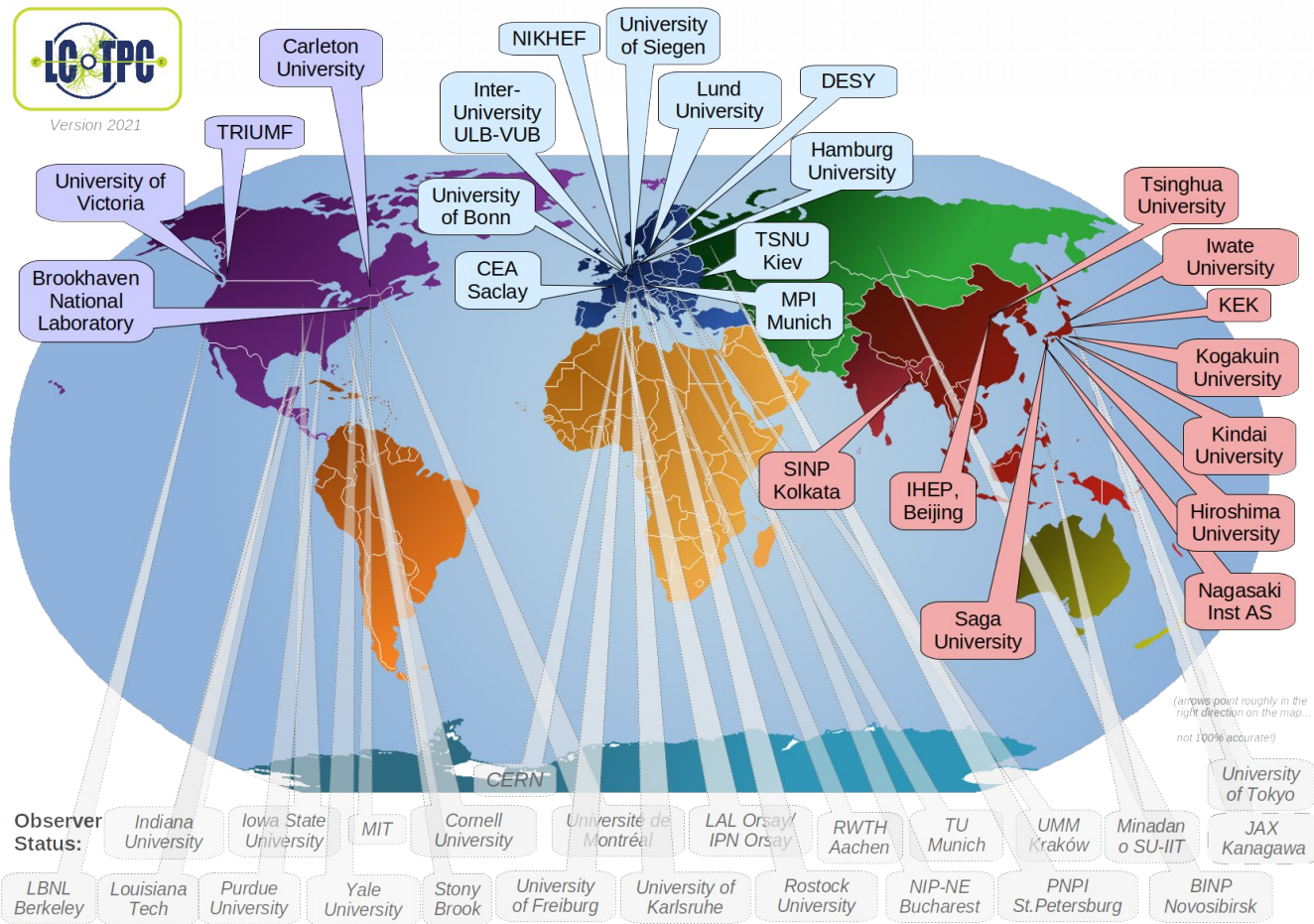

LCTPC-collaboration studies MPGD detectors for the ILD-TPC: 24 Institutes from 11 countries + 24 institutes with observer status

Various gas amplification stages are studied: **GEMs**, **Micromegas**, **GEMs with double thickness** and **GridPixes**.

MPGDs in TPCs

- **Ion backflow** can be reduced significantly
- **Small pitch** of gas amplification regions => strong reduction of $E \times B$ -effects
- **No preference in direction** => all 2 dim. readout geometries possible

Test setup at DESY

PCMAG: $B < 1.2$ T, bore diameter: 85 cm

Electron test beam: $E = 1-6$ GeV

LP support structure

Beam and cosmic trigger

LP Field Cage Parameter:

length = 61 cm

inner diameter = 72 cm

up to 25 kV at the cathode

=> drift field: $E \approx 350$ V/cm

made of composite materials: 1.24 % X_0

Modular End Plate

two end plates for the LP made from Al
7 module windows (one is space frame)

→ size $\approx 22 \times 17$ cm² (ILD: 240 modules/endcap)

Large Prototype has been built to compare different detector readouts under identical conditions and to address integration issues.

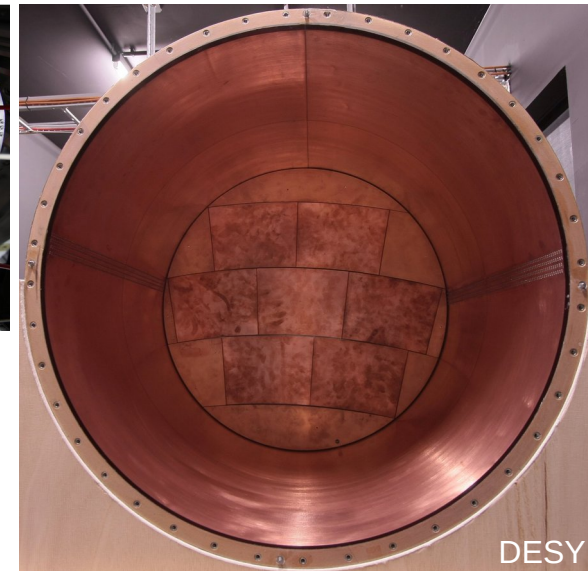
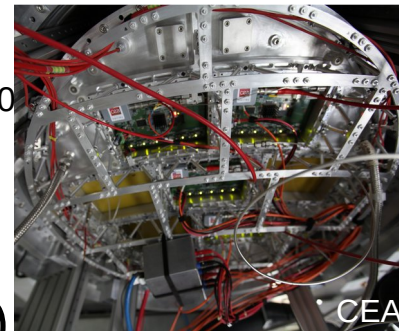
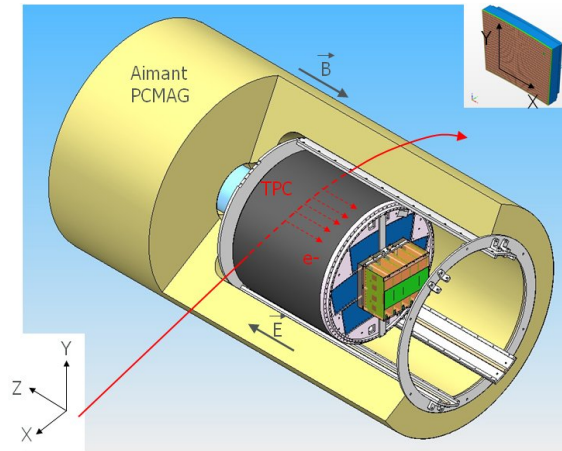

Setup at DESY



Further improvements of the test beam setup at DESY are in progress or planned:

- An external silicon tracker (LYCORIS) for the Large Prototype (LP) is advanced and first test beams have been performed. But there is still work to integrate everything. All groups will redo measurements with newest module types to study distortions.
- Current field cage shows misalignments of the axis to the endcaps.
 - Construction of an improved field cage for the LP.
 - Also important for learning to build the final detector.

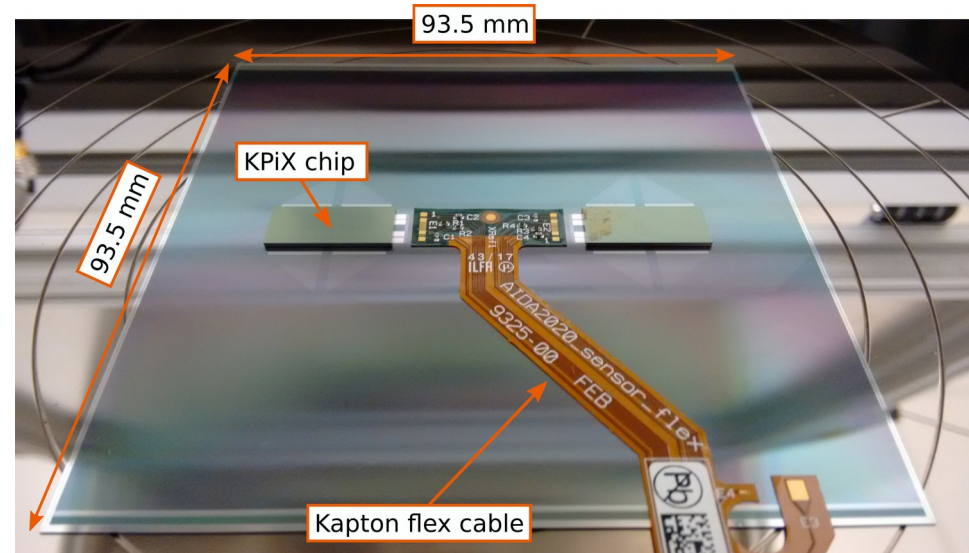
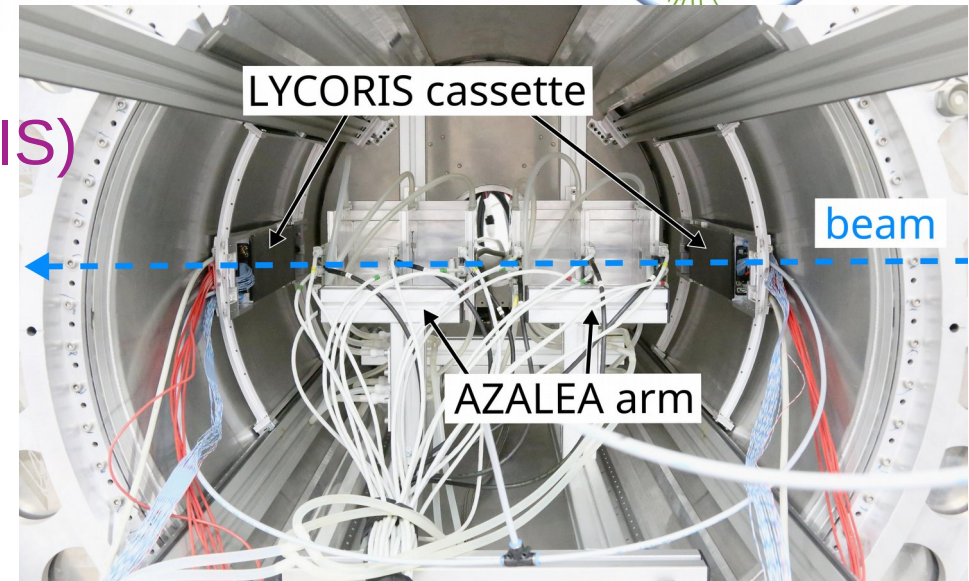

GEM Modules (I)

GEMs: copper-insulator- copper sandwich with holes

2 configurations are being tested:

- double GEMs with 100 μ m LCP insulator
- triple GEMs with 'standard CERN GEMs'

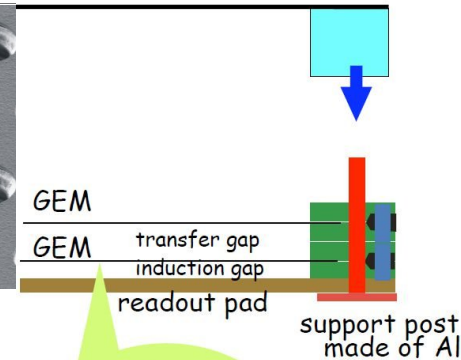
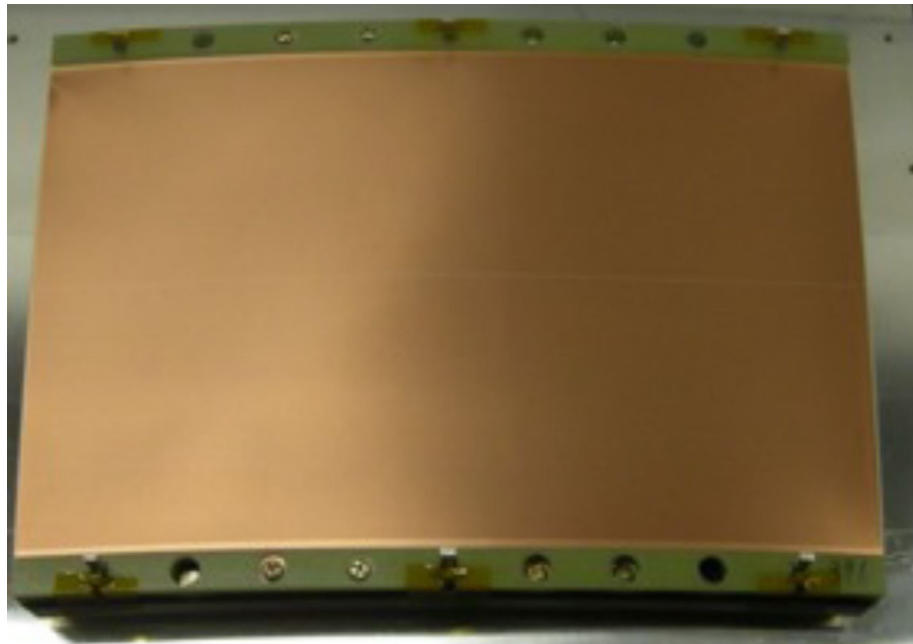

GEM Modules 1:

- 2 GEMs made of 100 μ m thick LCP
- 1.2 \times 5.4mm² pads

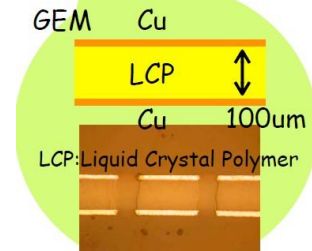

Design idea of GEM Modules 1:

- Minimize insensitive area pointing towards IP => no frame at modules sides
- Use thicker GEMs to give more stability
- Broader arcs at top and bottom

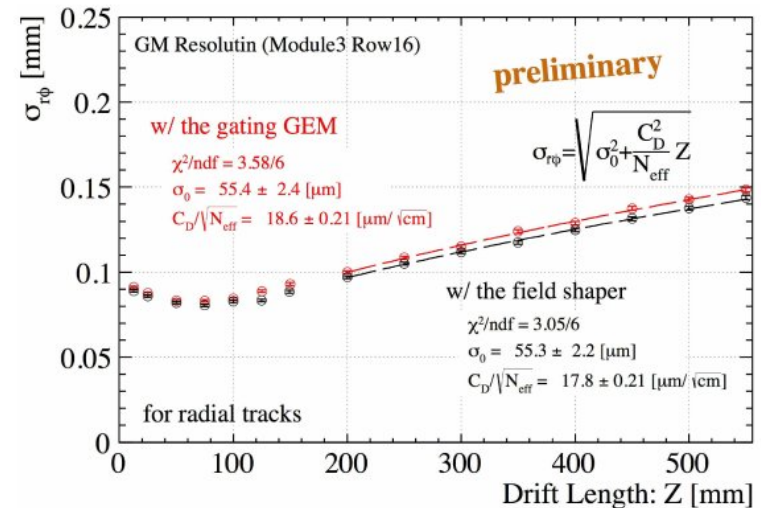

GEM-Modules (II)



Design idea:

Minimize dead area

Do not use frame to stretch GEMs, but a 1 mm grid to hold GEM

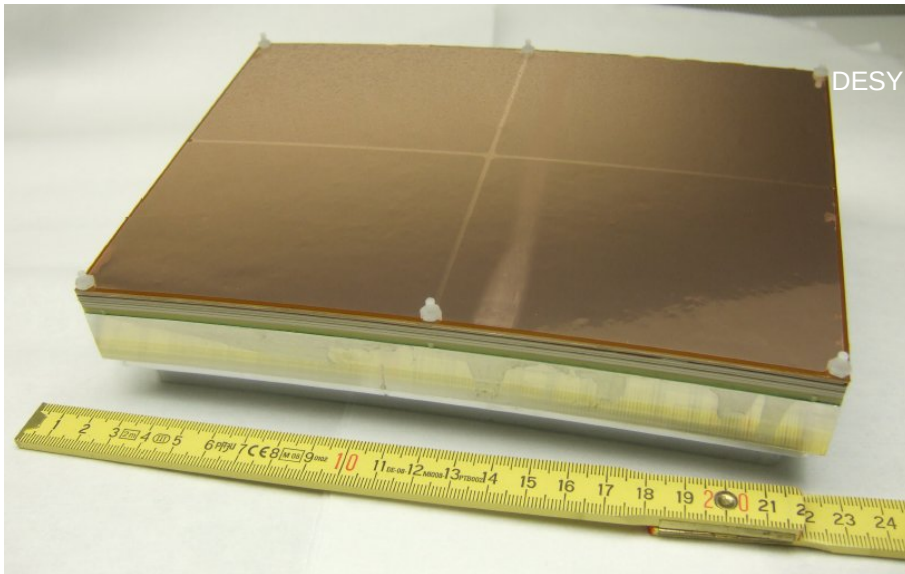

Spatial resolution published in first publication. Now, double track resolution and dE/dx performance is scrutinized. Also, in dependence on the pad sizes.

2 iterations of modules built:
 $1.26 \times 5.85 \text{ mm}^2$ pads – staggered
 Field shaping wire on side of module

New publication in preparation:

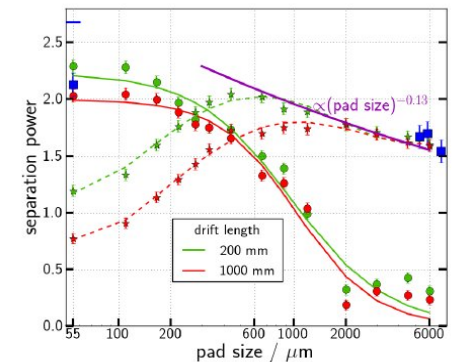
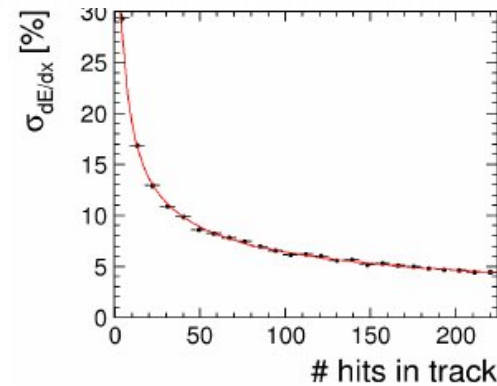
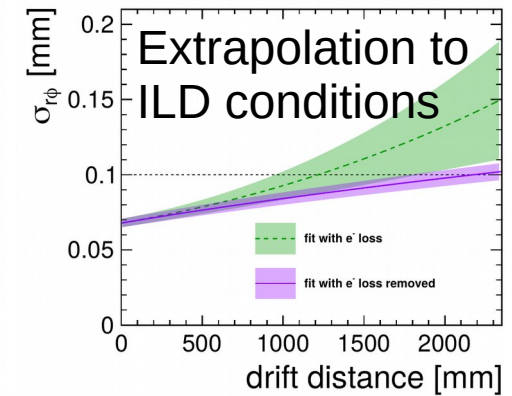
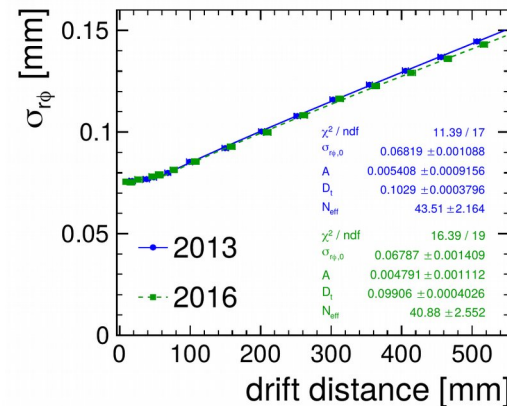

Resistive Micromegas



Resistive Micromegas: Bulk-Micromegas with 128 μm gap size between mesh and resistive layer

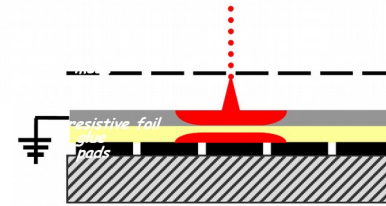

NIM A581(2007) 254

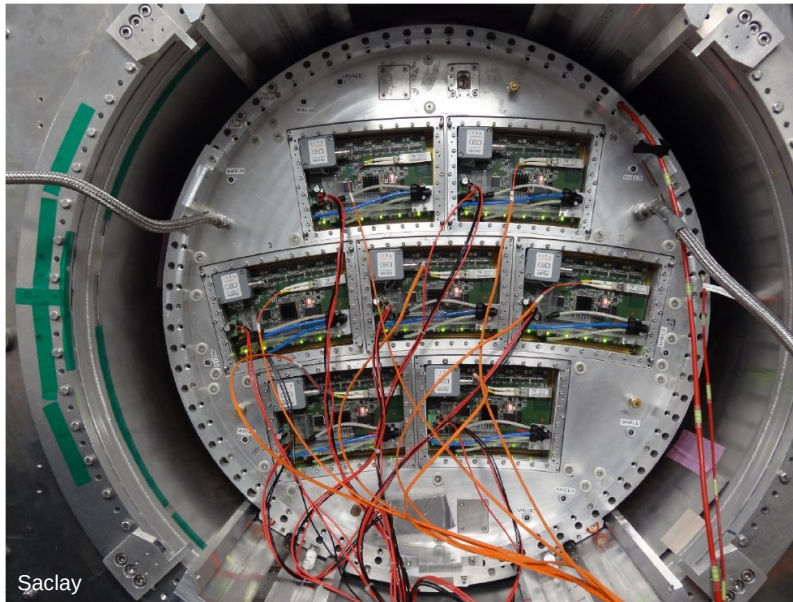

New publication in preparation:

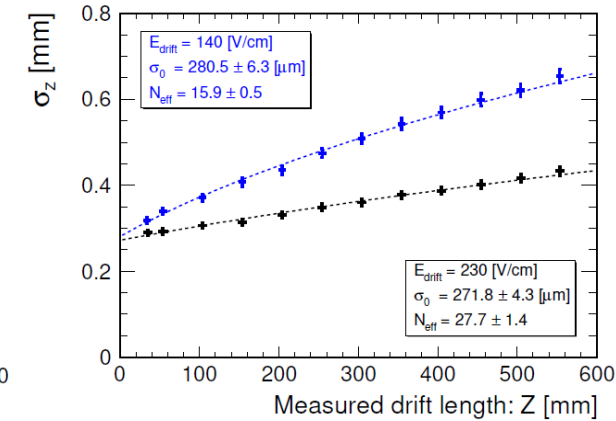
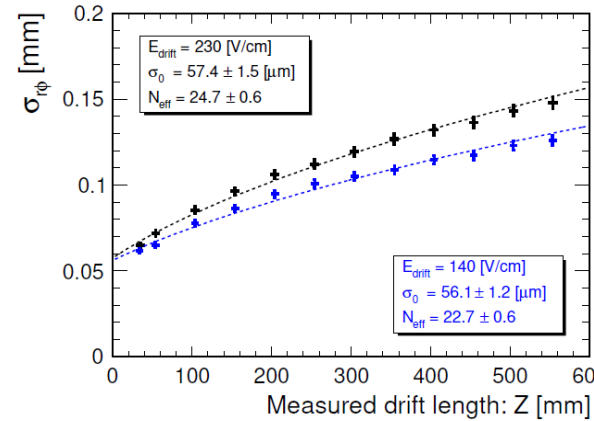

A new HV scheme of the module places **grid on ground potential** and reduces field distortions significantly.

Old scheme (RAM)

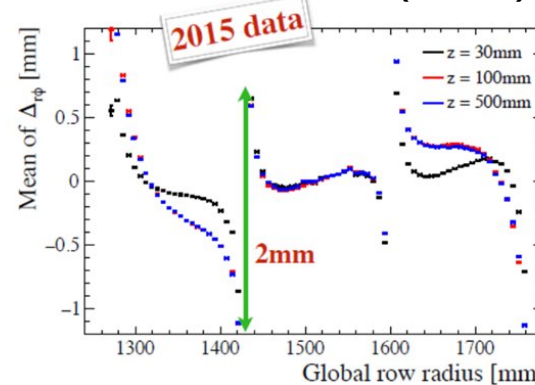

New scheme (ERAM)

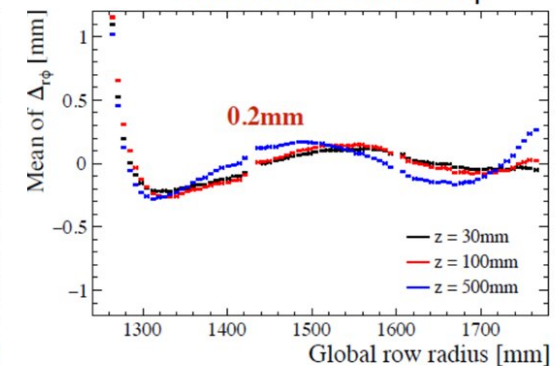

Detector Modules



GEM and Micromegas groups have finished analysis of test beam data with previous set of detector modules. Both technologies show **very similar performance**. Now groups want to implement improvements in a **new generation of modules**. They are discussing new common modules with

- a more final design and
- a more comparable design.

These **common modules** should have a

- common readout electronics (sALTRO),
 - an identical gating device (gating GEM) and
 - possibly a common pad plane
- Only the gas amplification stage differs => better comparison of performance for a technology decision.

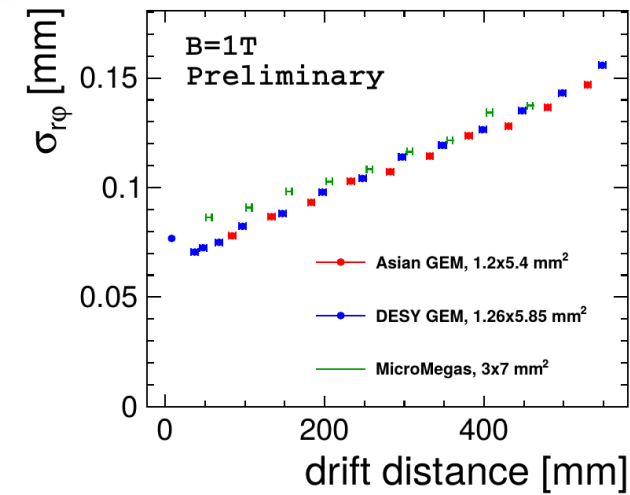

Improving Micromegas: GridPix

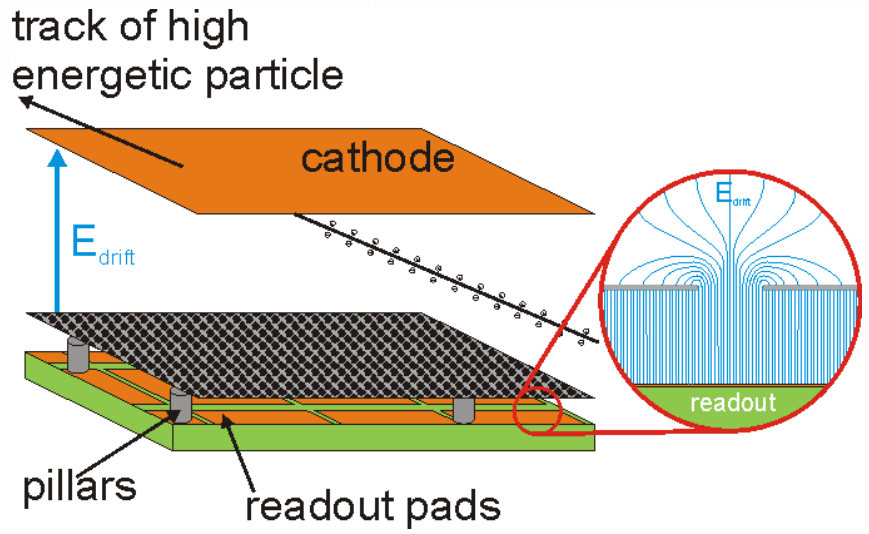

Standard charge collection:
 Pads / long strips
Instead: Bump bond pads are used as charge collection pads.

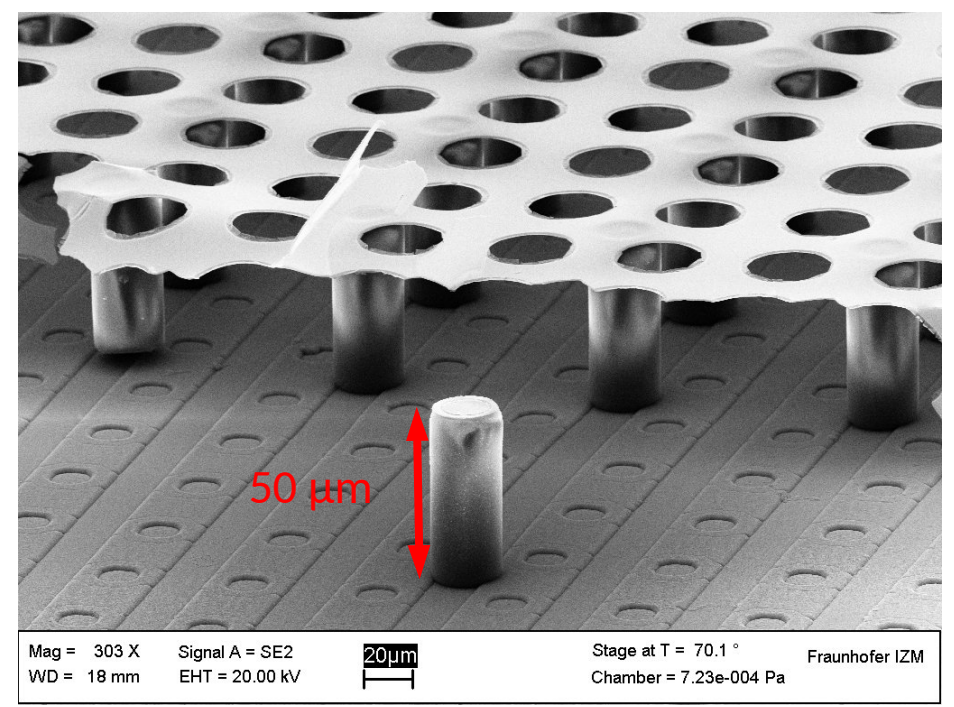

Could the spatial resolution of single electrons be improved?

Diffusion in amplification region:

Ar:CO₂ 80:20 → $\sigma = 11 \mu\text{m}$

Ar:iC₄H₁₀ 95:5 → $\sigma = 11 \mu\text{m}$

Ar:CF₄:iC₄H₁₀ 95:3:2 → $\sigma = 11 \mu\text{m}$

Smaller pads/pixels could result in better resolution!

At NIKHEF the GridPix was invented.

- Lower occupancy → easier track reco
- Removal of δ -rays and kink removal
- Improved dE/dx (4% seems possible)
- No angular pad effect

Large Scale Readout



To readout the TPC with GridPixes:

~100-120 chips/module 240 module/endcap (10 m²) → 50000-60000 GridPixes

Demonstration of mass production: One LP-module covered completely with GridPixes (96 → coverage 50%) and two partially covered modules.

In total 160 GridPixes covered an active area of 320 cm² (10M pixel detector).

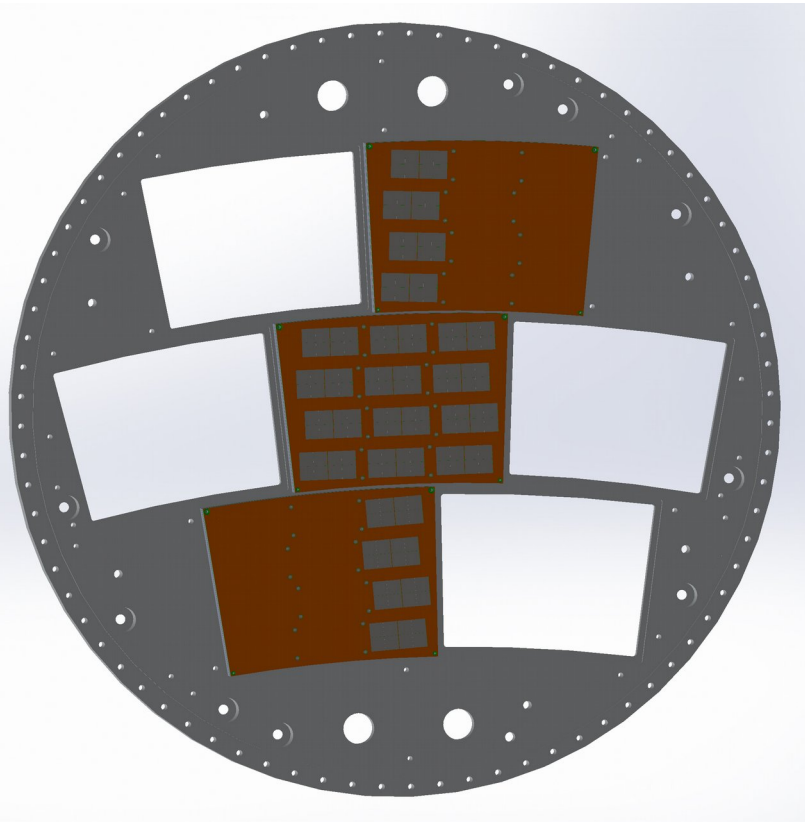

The test beam was a huge success: **A pixel TPC is realistic.** During the test beam we collected ~10⁶ frames at a rate of 4.3-5.1 Hz.

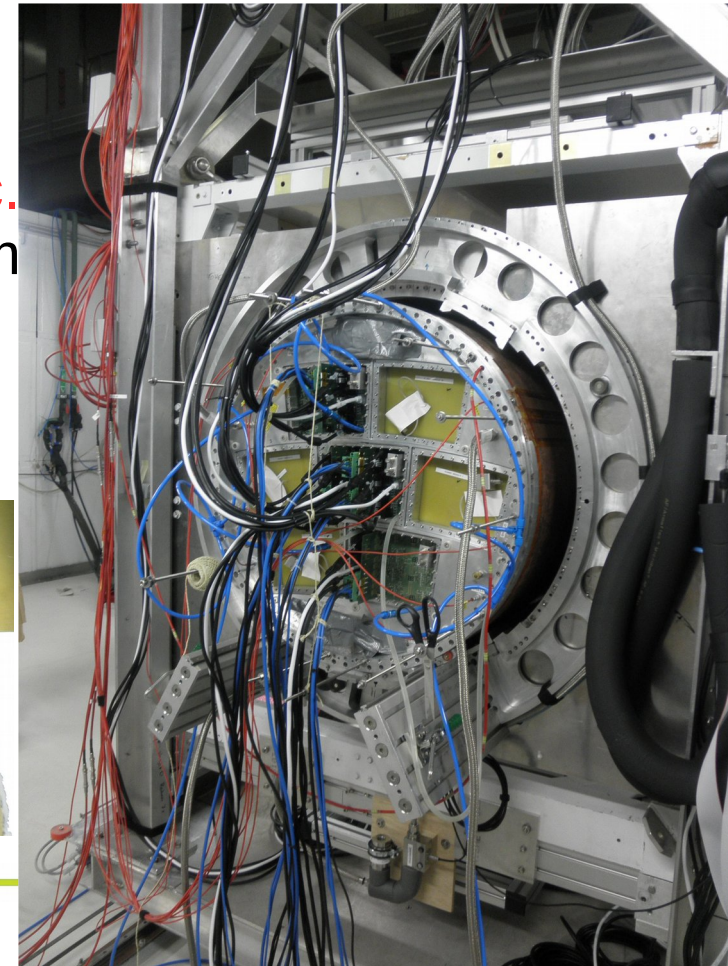
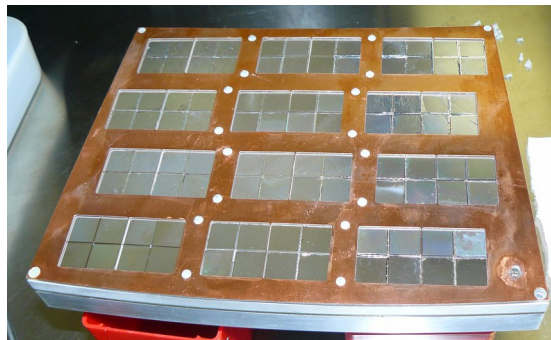

Timepix3-based GridPix



GridPix detector have moved from Timepix to **Timepix3** ASICs. Tests with **single and quad** devices have been successfully done and published.

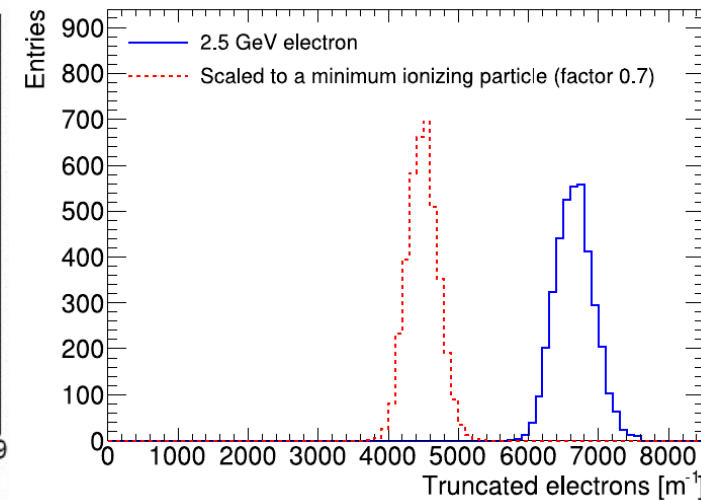
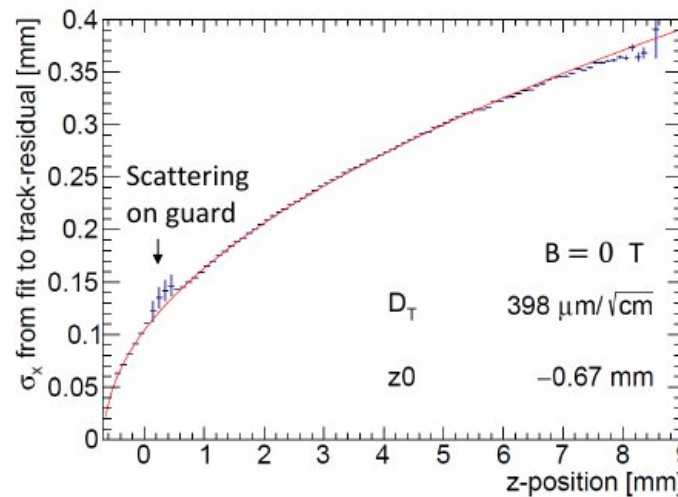

A first module with **32 GridPixes** has been constructed and will be tested in a planned test beam at DESY - including a test in a magnetic field. A complete LCTPC module would consist of about 100 GridPixes.

The ion back flow of the module has been measured and can be further reduced by applying a double grid. Also the resistivity of the protection layer will have to be reduced.

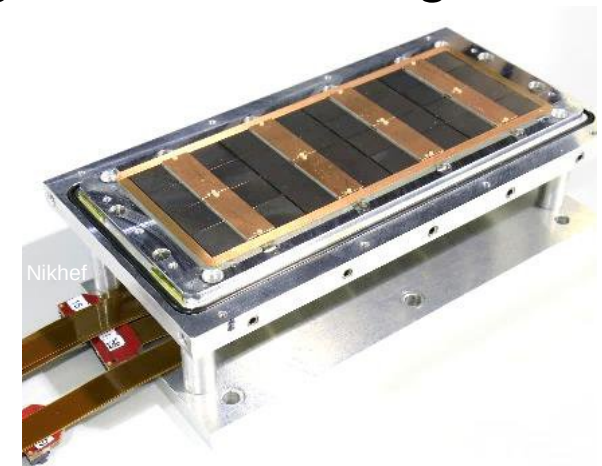

Ion Feedback and Gating



Primary ions create distortions in the electric field which result in $O(<1\mu\text{m})$ track distortions including a safety margin of estimated BG.

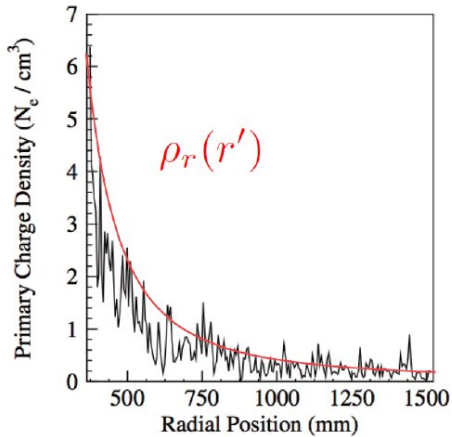

- Machine induced background has $1/r$ shape
- Ions from gas amplification stage build up discs
- Track distortions are $20\ \mu\text{m}$ per disc without gating device, if IBF is $1/\text{gain}$
- Total: $60\ \mu\text{m} \Rightarrow$ **Gating is needed**

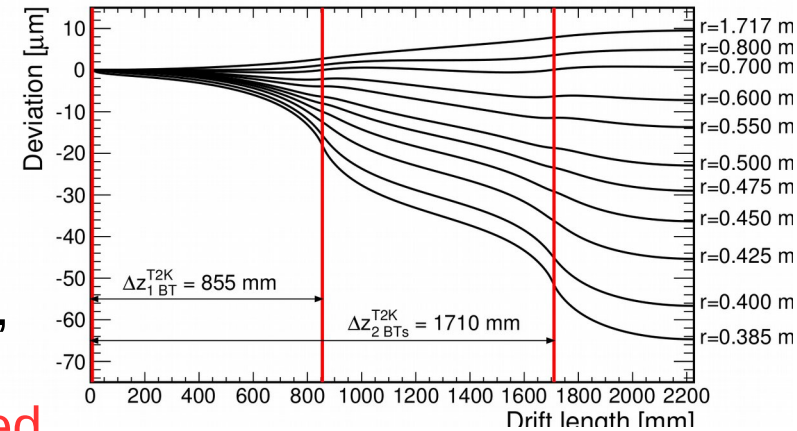

- Wire gate is an option
- Alternatively: GEM-gate
- Simulation show: Maximum electron transparency is close to optical transparency
- Fujikura Gate-GEM Type 3
Hexagonal holes: $335\ \mu\text{m}$ pitch, $27/31\ \mu\text{m}$ rim
Insulator thickness $12.5\ \mu\text{m}$

Bunch structure at ILC:
Charging the superconducting cavities takes 0.1-0.2 s, then bunch trains of 1 ms can be accelerated.

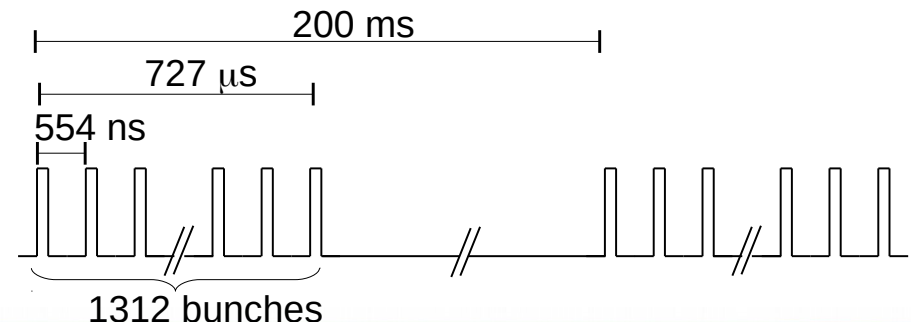

Gating GEM



The gating GEM is a favorite, which has large holes (\varnothing 300 μm) and thin strips inbetween (30 μm).

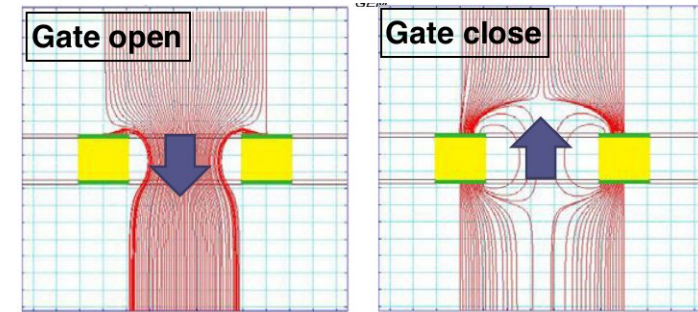
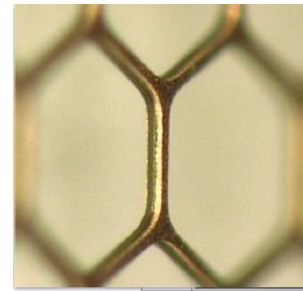

The **electron transparency** has been determined with different measurements and corresponds to **82 %** as expected from **simulations**.

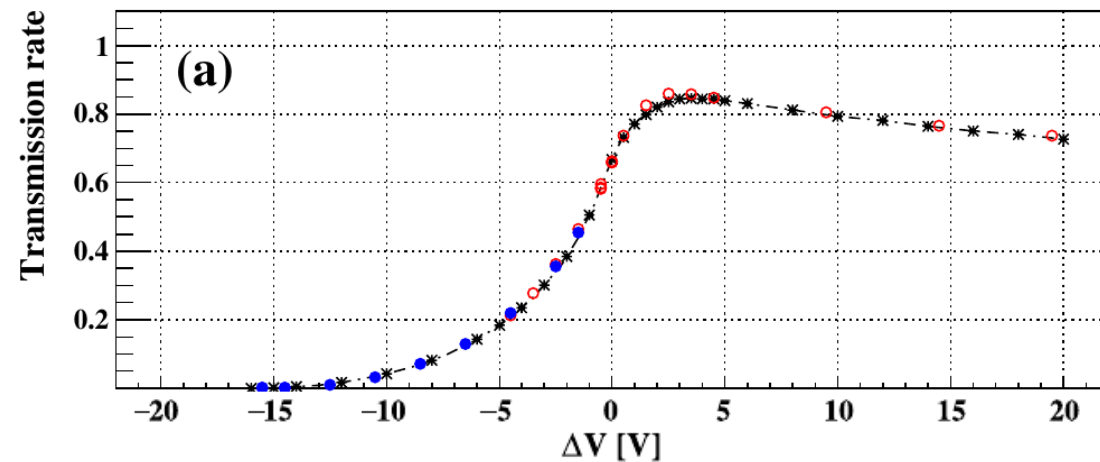

The ion blocking power still has to be determined and quantified. First measurements have been initiated for this, but no results yet. Also a fast HV switching circuit has to be developed. The gate should also be tested in $B = 3.5\text{-}4$ T.

Cooling

Despite the power pulsing, the readout electronics will require a cooling system. **2-phase CO₂-cooling** is a very interesting candidate. A fully integrated AFTER-based solution has been tested on 7 Micromegas modules during a test beam.

To optimize the cooling performance and the material budget, **3D-printing** is an attractive possibility for producing the complex structures required. A prototype for a full module is available now at CEA, Saclay. It will be increased to 4 modules until 2021.

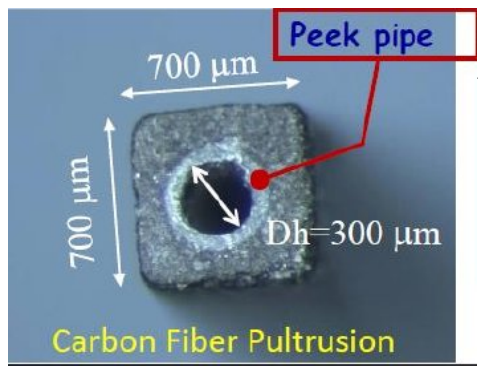
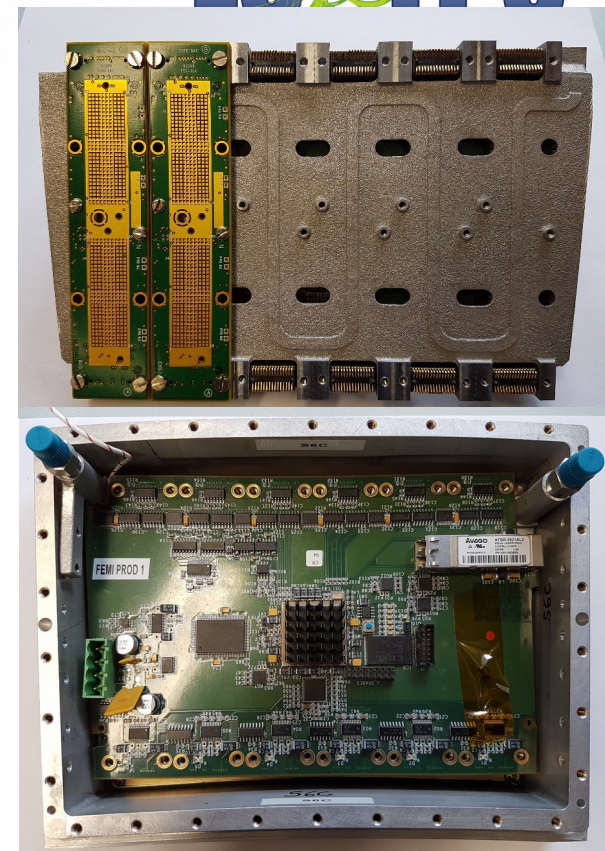

Alternatively, Lund is exploring **micro channel cooling** together with Pisa. These consists of pipes with $\text{\O} 300 \mu\text{m}$ in carbon fiber tubes.

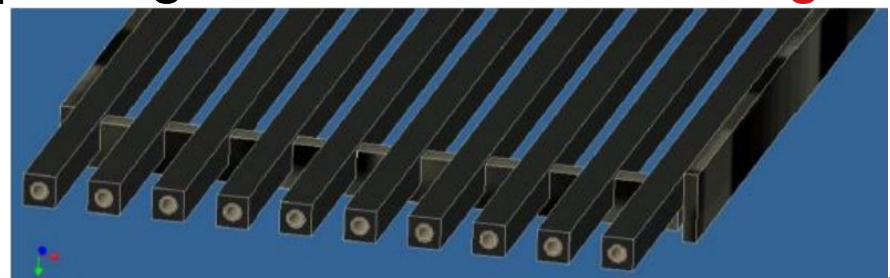

Timeline

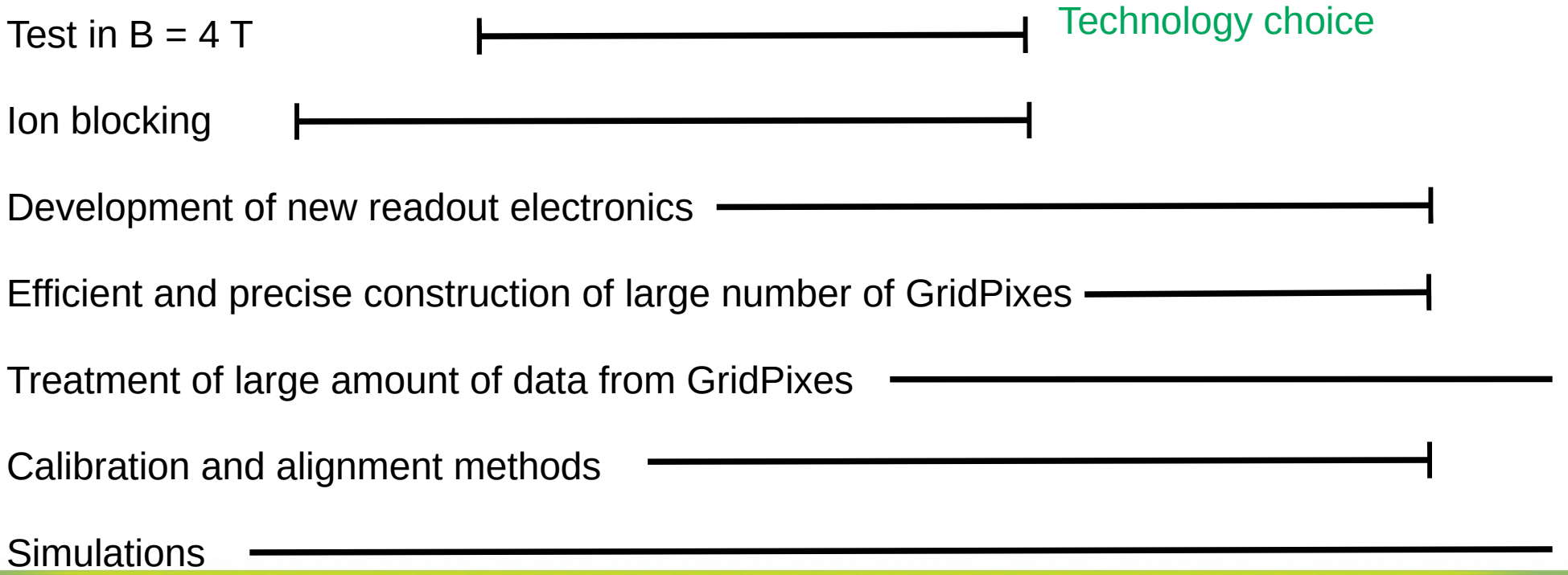
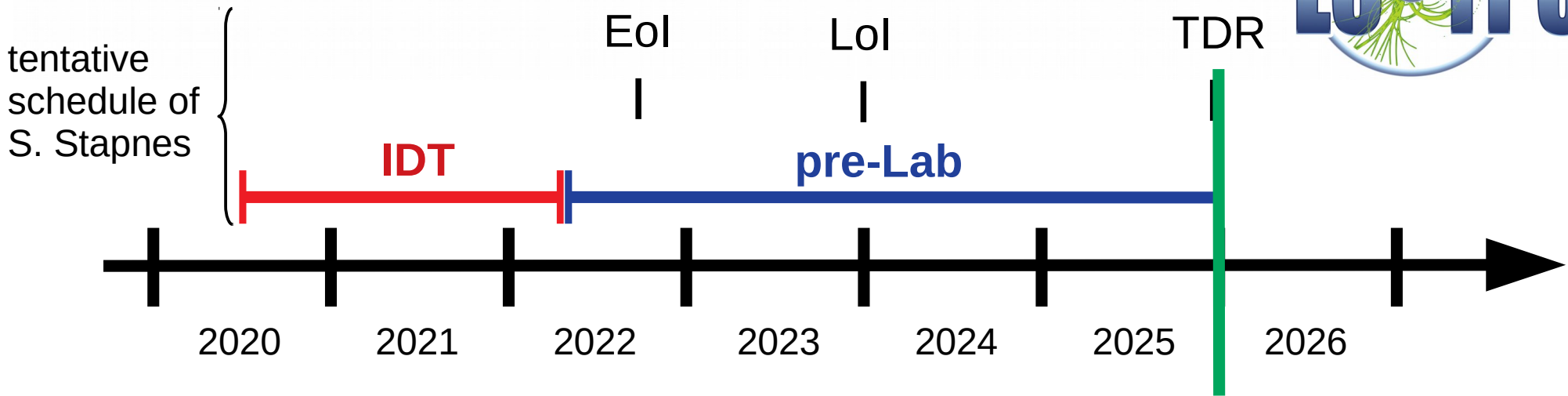

Technology choice

Summary



- Continue GEM, Micromegas and pixel tests at the LP in preparation for the preliminary design of the TPC during the pre-Lab phase.
- A gate should be included in the next-generation GEM, Micromegas and pixel modules.
- Synergies with T2K / ALICE / CEPC/ EIC allow us to continue R&D and of course we learn from their experiences and R&D. We are also open for people interested in applications beyond the scope of ILC.
- Continue electronics, cooling and powerpulsing development.
- Many simulations are still necessary to understand the detailed requirements of the final detector (e.g. number of ADC bits, pad sizes, etc.), **but also new ideas for old challenges are welcome.**



Backup

Online Event Display (1)

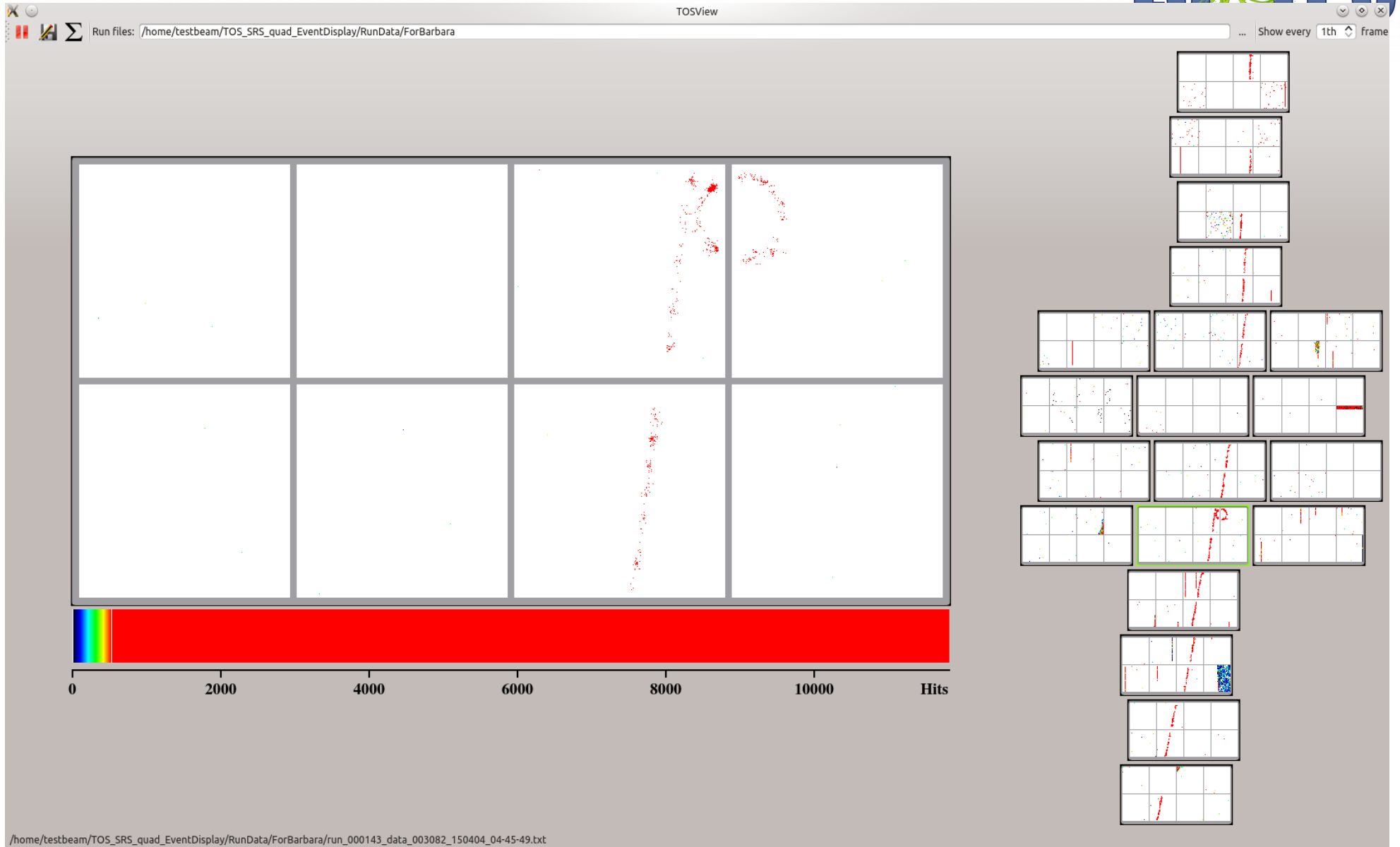

Online Event Display (2)

